

The Wireless AND RADIO REVIEW World

No. 316.

WEDNESDAY, SEPTEMBER 2ND, 1925.

VOL. XVII. No. 10.

<p>Assistant Editor: F. H. HAYNES.</p> <p>Editorial Offices: 139-40, FLEET STREET, LONDON, E.C.4</p> <p>Advertising and Publishing Offices: DORSET HOUSE, TUDOR STREET, LONDON, E.C.4</p> <p>COVENTRY: Hertford Street.</p> <p><i>Telegrams: "Cyclist Coventry." Telephone: 10 Coventry.</i></p>	<p>Editor: HUGH S. POCKOCK.</p> <p>BIRMINGHAM: Guildhall Buildings, Navigation Street.</p> <p><i>Telegrams: "Autopress, Birmingham." Telephone: 2970 and 2971 Midland.</i></p>	<p>Assistant Editor: W. JAMES.</p> <p>Telephone: City 4011 (3 lines).</p> <p>Telephone: City 2847 (13 lines).</p> <p>MANCHESTER: 199, Deansgate.</p> <p><i>Telegrams: "Hiffe, Manchester." Telephone: 8970 and 8971 City.</i></p>
<p>Telegrams: "Ethaworld, Fleet, London."</p>		
<p>Subscription Rates: Home, £1 1s. 8d.; Canada, £1 1s. 8d.; other countries abroad, £1 3s. 10d. per annum.</p> <p><i>As many of the circuits and apparatus described in these pages are covered by patents, readers are advised, before making use of them, to satisfy themselves that they would not be infringing patents.</i></p>		

THE WIRELESS SEASON.

SEPTEMBER has come to be regarded as the opening month of the wireless season. As time goes on the seasonal aspect becomes less pronounced because the indispensability of wireless throughout the year is coming to be recognised more and more and it is no longer regarded as principally a winter pastime.

The opening of the wireless season this year is to be heralded by the Wireless Exhibition at the Royal Albert Hall, conducted under the auspices of the National Association of Radio Manufacturers and Traders. Amateurs and enthusiastic home-constructors, who form such a great and enlightened section of the vast body of listeners in this country, are eagerly awaiting the manufacturers' display of new apparatus. It is reasonable for them to suppose that there have been improvements in the design of such parts as tuning condensers, coils, transformers, chokes, and valves, and that new gadgets are being brought out, whilst a wide variety of sets of new types is certain to appear for the first time. Indeed, we have already had the opportunity of examining many of these, and note with pleasure the extent of technical progress made, influenced to no small extent, we believe, by the technical articles which appear in *The Wireless World*. But is the provision of improved apparatus the whole duty of the manufacturers? Is it not equally their responsibility to provide the fullest information to enable the public to choose and use their products correctly?

The Need for Explanatory Literature with Apparatus.

Too often it happens that purchasers of apparatus are disappointed, not because the quality of the set or component is unsatisfactory, but solely because the manufacturer has assumed that the operation of a set or the correct use of a component does not require any explanation from them.

Much might be said regarding the sale of sets without proper descriptive and explanatory literature to guide the purchaser in operating, and the attitude of many manufacturers of components might be similarly criticised, but for the moment, as a particular instance, we will make reference only to that essential component, the valve.

The Special Case of Valves

Valves as distributed by the manufacturer are usually labelled "H.F." or "Detector" or "L.F.," and an average figure given for the plate impedance and amplification factor with the filament and plate operating voltages. The amplification factor and impedance are usually taken around zero grid potential, with a relatively large plate voltage. Such information is, apart from the filament characteristic, practically useless. In the first place it is invariably found that the H.F. type of valve is one of high amplification factor with a correspondingly high impedance, while the L.F. valve has a lower impedance. It might, therefore, be thought that the valve labelled "H.F." is the best valve to use in a high frequency amplifier, but such is not the case. With the step-up transformer coupling, which is now so widely used, a

CONTENTS.

	PAGE
EDITORIAL VIEWS	273
PRACTICAL CRYSTAL OSCILLATOR	275
By L. L. Barnes.	
BRITISH AMATEUR'S TELEPHONY RECORD	280
THE WORLD'S LARGEST BROADCASTING STATION	281
NOVELTIES FROM OUR READERS	283
CURRENT TOPICS	285
SINGLE VALVE BROADCAST RECEIVER	287
By A. R. Turpin.	
BROADCAST BREVITIES	291
CRYSTAL DETECTORS	293
By F. M. Colebrook.	
NEW APPARATUS	297
LETTERS TO THE EDITOR	298
READERS' PROBLEMS	299

valve with a low impedance (which will have a low amplification factor) should be employed, that is, a valve labelled "L.F.," and so on.

Secondly, an amplifying valve is rarely used with its grid at zero potential and with a high plate voltage. The grid is given a negative bias, and for each value of grid voltage there is one value of plate voltage which will be most economical in plate current. The characteristics of valves should therefore be given as nearly as possible for practical operating conditions. To quote the amplification factor and impedance at near zero grid potential is wrong, because in general it makes the valve appear to be a much better one than if really is as used in a receiver.

Our Own Method.

We ourselves, when reporting on the properties of different valves, give the fullest practical information. In our reports on valves tested we state the amplification factor, plate impedance, and plate current at various plate voltages, with the correct grid bias. The reader is then able to see at a glance how to use the valve. Further, he is able to choose a suitable valve for the particular form of coupling he employs, provided, of course, that he knows the characteristics of the couplings. Here, again, it is not too much to expect that manufacturers will give the fullest technical particulars. In the case of L.F. transformers the important feature is the impedance of the primary at a given frequency—the ratio being of minor importance.

Misjudgment of the Manufacturer.

It would, of course, be possible to quote other instances where it is essential that data should be supplied, but the examples given above are sufficient to make clear our point of view, and we hope that manufacturers will recognise that in supplying such detailed information they will, at the cost of comparatively little additional trouble, be insuring against a misjudgment of their products on the part of the public, brought about solely through withholding essential information.

WHAT THE B.B.C. IS DOING.

THE importance of an opening season is fully recognised by the B.B.C., to judge from their activities and the arrangements which are announced for the near future. We understand that some important innovations will take place in the matter of the programmes themselves because it is recognised that the winter draws more

listeners. Nothing quite definite is decided as yet regarding the second station for the London area, as Post Office sanction has not, we understand, been obtained definitely for this; but in any case it is certain that Daventry will have its own programme to a greater extent, and will not be so dependent as at present on relaying from London.

The Hayes Station.

Another direction in which interesting developments are promised is connected with the setting up of the B.B.C. receiving station at Hayes. The ultimate purpose is to put the B.B.C. in the position of being able to receive foreign programmes for re-broadcasting from any of the British stations. It will be remembered that some time ago experiments of this nature were tried in connection with Continental stations, but in the absence of adequate arrangements by the B.B.C. to carry out this work, it could not be regarded as anything beyond an experiment, whereas it is anticipated that it will be possible in the future for foreign programmes to be put on during the ordinary programme hours, and, possibly, included as a regular feature.

We understand that the immediate introduction of this innovation must not be looked for, although it has been announced in various quarters that it will be introduced almost at once. We understand that the B.B.C. are anxious not to introduce the scheme until they are fully satisfied as to its ultimate success.

o o o o

THE ANNUAL EXHIBITION.

THE annual Wireless Exhibition is again to be held at the Royal Albert Hall this year, from September 12th to 23rd inclusive. There is every indication that this will be an exhibition of remarkable interest, and readers of *The Wireless World* should not miss the opportunity which will be provided of seeing the latest developments in broadcast receivers and components. The opportunity will be taken by the organisers to celebrate the thirtieth anniversary of Marconi's first successful experiments in Italy. The issue of *The Wireless World* for next week will contain a special section providing a guide to the exhibition, with an illustrated forecast of the exhibits. This issue should be in the hands of visitors to the exhibition, as it will form a useful indication of what to see. A second exhibition issue to be dated September 16th will review outstanding features, special attention being given to new products.

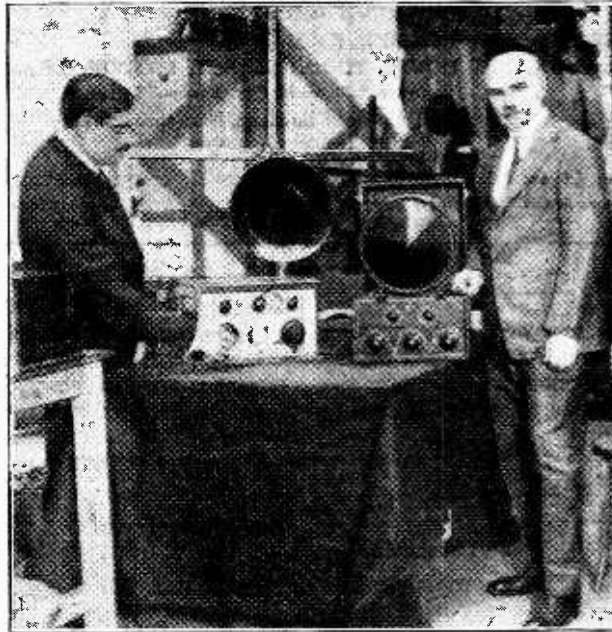

TWO FAMOUS WIRELESS PERSONALITIES. Lucien Levi, whose important patents have recently been upheld in the U.S. courts, is seen with Dr. Lee de Forest, famous for the third electrode of the valve, and for his inventions in connection with the speaking film.

Practical Crystal Oscillator

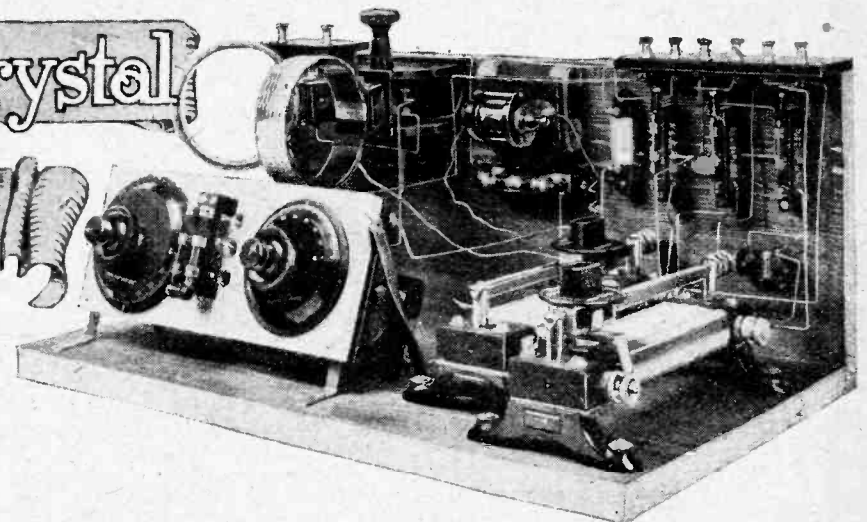

Details of a Successful
Oscillating and Ampli-
fying Crystal Receiver.

By L. L. BARNES.

MUCH interest has recently been aroused in the encouraging results obtained from the oscillating crystal used as amplifier, and the writer has received from all parts of the country and abroad requests for information and practical details of an amplifying crystal set.

One correspondent asks:—" . . . Where is the 'snag'? Why are crystal amplifiers not used in place of valves? Presumably there are some limitations or other good reasons for the lack of actual application of the arrangement . . ."

There is no "snag." This system of amplification merely needs development, and it furnishes an inexpensive and highly interesting line of research for the serious experimenter. It is with this in view that the construction of the amplifying crystal set is here described together with hints on the manipulation and suggested lines of experiment.

Layout of the Components.

The photograph shows the general arrangement. It will be noticed that no components are boxed up or concealed behind artistically finished panels, but that all con-

nections are readily accessible. This is an important consideration in the construction of a set that is for experimental purposes, and not simply a broadcast receiver.

The circuit employed is given in Fig. 1, and corresponds to Fig. 3 of a previous article (*The Wireless World*, May 6th, 1925), in which the principles of the action and application of the oscillating crystal were briefly discussed.

Condensers.

Two variable condensers C_1 and C_2 are used; the former is for tuning the primary circuit, and has a maximum capacity of 0.0005 mfd.; and the latter serves the double purpose of tuning the secondary circuit and preventing the battery from discharging through the inductance. It has a capacity of 0.0003 mfd., and should be of the "square-law" type and fitted with an extra vane for vernier adjustment.

These condensers (as shown in Fig. 2 and in the photographs) are mounted on a wooden panel 4in. x 9½in. x ¾in., fixed in a slanting position by means of a fairly stout ¾in. brass strip. The condensers are mounted symmetrically on this panel, and between them is a double-pole, double-throw knife switch acting as a series-parallel switch for the aerial tuning condenser. Holes are drilled sufficiently large to allow the wire connections to this switch to pass through, but clear of, the wooden panel. It must be remembered that, although all components are mounted on wood, they must be individually insulated therefrom.

Inductances.

A two-way coil holder is mounted on the vertical board at the back of the set, as shown in Fig. 10. The degree of coupling is a critical factor in tuning, and the coil holder must, therefore, be fitted with some type of vernier adjustment. A good range of plug-in honeycomb or basket coils should be obtained, suitable sizes being Nos. 35, 50, 75, 100, 150, and 200. But anyone not wishing to go to the expense of buying or the trouble of winding these coils can make good use of the more easily constructed loose-coupler, with a fair number of tappings on both primary and secondary. The loose-coupler with

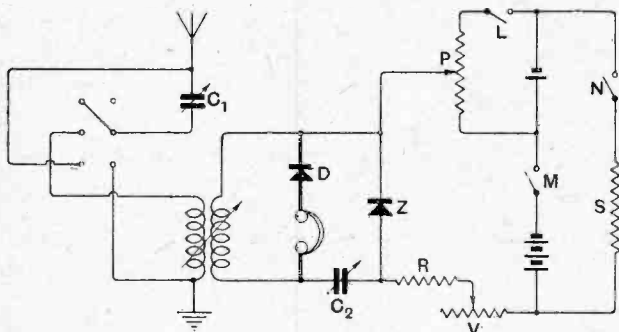

Fig. 1.—The circuit diagram.

The baseboard may consist of deal, and measures

Practical Crystal Oscillator.—

tappings is less efficient than well-made plug-in coils, but in some respects more convenient for this purpose.

Crystals.

The detecting crystal D should be of a more or less permanent type; the R.I. "Permanent Mineral De-

of fine copper or Eureka wire of about No. 36 S.W.G to make very light contact with the crystal.

The hair-spring of a small clock answers still better, the end being cut off obliquely (if the spring is of the ribbon type) to give a sharp point, and bent round as shown in Fig. 3—a troublesome business, but well worth the time expended.

A "Mic-Met" detector is the most convenient type, though "detector" is hardly the correct word. Let us call it the "crystal booster,"

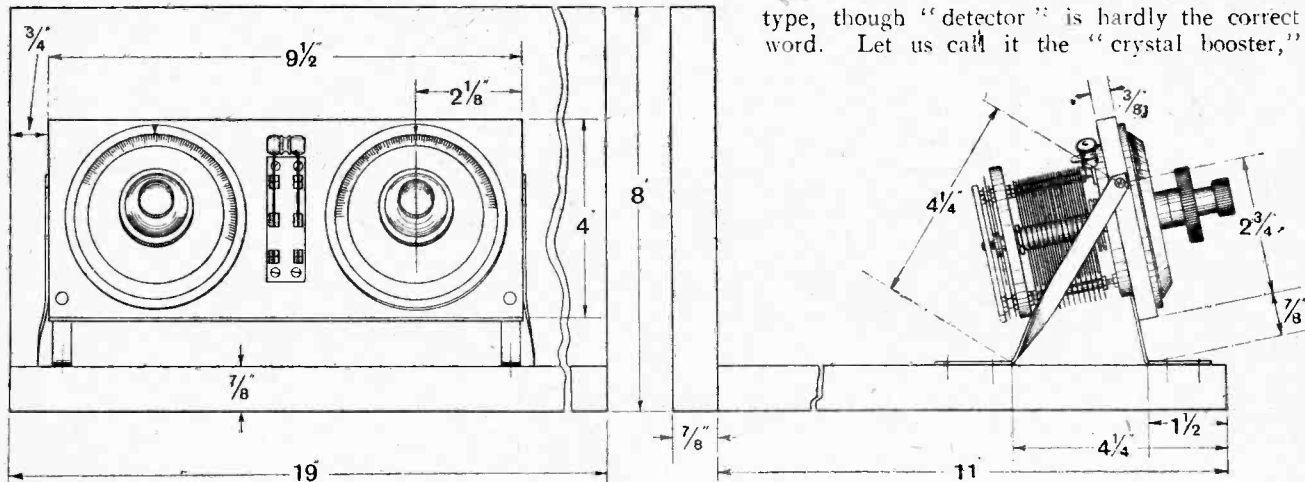

Fig. 2.—Method of mounting the variable condensers.

tor" can be recommended, and the Perikon combination of zincite and copper pyrites is quite suitable, as a high-resistance detector is needed in this circuit. In any case a detector employing a metal catwhisker should be avoided here. The detector is fixed to an ebonite base and screwed down in the position shown in Fig. 10.

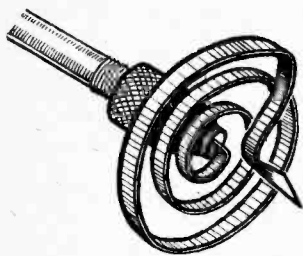

Fig. 3.—Steel hair-spring catwhisker for the crystal oscillator.

The oscillating crystal Z consists of zincite and has a steel contact. It is unfortunate that not all zincite crystals will act as oscillators; but usually one of dark red colour possesses some sensitive points. A zincite crystal is improved by fusing in an arc, but many unfused specimens are quite satisfactory, and the very act of using them causes minute arcs to occur at the point of contact which tend to fuse the surface, with the result that the crystal becomes more and more sensitive with use.

The steel catwhisker can be made by soldering about 1/8 in. of the pointed end of a needle on to a small spiral

therefore, as distinct from the "crystal detector," which is used solely for rectification.

The crystal booster is mounted on rubber sponge or felt to prevent vibration. The best scheme of mounting is illustrated in Fig. 4. Two strips of stout rubber, each 5 1/2 in. long x 1/2 in. wide and thickness about 1/8 in. (depend-

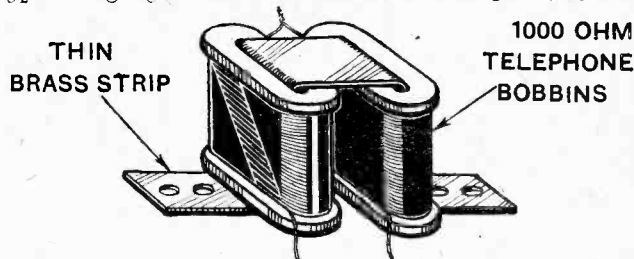

Fig. 5.—Method of mounting telephone bobbins for stabilising resistance.

ing on the consistency), are attached to the underside of the ebonite base of the booster, and the ends doubled back and bolted to the back of the set, as indicated in Figs. 4 and 10. The result is very satisfactory, as the adjustment of the contact on the crystal, critical though it is, remains stable for several days.

It is imperative that this precaution should be taken, as readjustment of the oscillating crystal is much more troublesome than that of the ordinary detector. For the same reason, leads to the crystal booster must be of fine wire (say No. 36 S.W.G.), or, better still, thin rubber-covered flex.

Resistances.

The shunt S (Fig. 1) consists of about two yards of No. 40 S.W.G., S.S.C. Eureka resistance wire wound on ebonite. This shunt is introduced by means of a switch

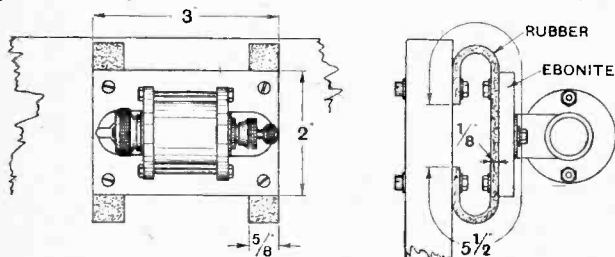

Fig. 4.—Anti-vibration mounting for crystal oscillator.

Practical Crystal Oscillator.—

placed immediately above it. Its function has been described in the previous article already referred to.

R is a stabilising resistance of 1,500 to 2,000 ohms. It can be wound on a strip of ebonite with fifty yards of No. 40 S.W.G., S.S.C. Eureka wire, or, more simply, can consist of two 1,000-ohm telephone bobbins. These bobbins can be obtained very cheaply, and should be threaded on a short length of thin brass strip, which is then bent in the manner shown in Fig. 5, and screwed down, as indicated, to one side of the crystal booster, about 6in. from the right-hand edge of the vertical board.

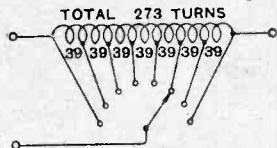
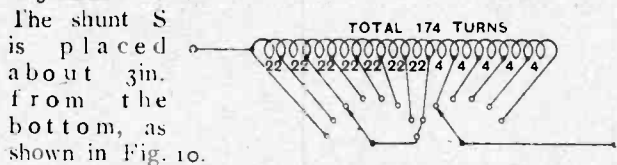

Fig. 6.—Tappings for potentiometer shown in Fig. 8.

Fig. 7.—Tappings for variable resistance shown in Fig. 8.



The shunt S is placed about 3in. from the bottom, as shown in Fig. 10. In series with R is the variable resistance V (Fig. 1), having a maximum resistance of about 400 ohms, while P is a potentiometer having a resistance of 700 ohms. "Zenith" rheostats are ideal for use here, as it is imperative that the sliders should always maintain perfect contact with the wire, and home-wound rheostats are usually somewhat faulty in this respect. These variable resistances are placed side by side on the baseboard to the right of the condensers, as shown in the photograph and the wiring diagram (Fig. 11).

Those readers who prefer to construct their own potentiometer and variable resistance are advised to employ the following methods:—

Switch arms and studs are used in place of sliders, tappings being taken at the points indicated in Figs. 6 and 7. The resistance wire is No. 36 S.W.G. enamelled Eureka—one ounce will be ample. It is wound on a well-shellac-varnished cardboard former 2in. in diameter and 7½in. long. Start ¼in from one end, and wind on

273 turns, making a loop for tapping at every 39 turns (see Fig. 6). This forms the winding for the potentiometer.

Separated from this by ¼in. are 174 turns with loops

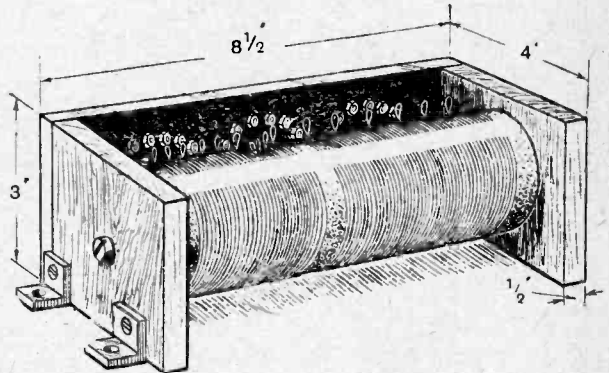

Fig. 8.—Rear view of potentiometer and variable resistance windings employing switch arms and studs instead of slider.

for tappings at the points indicated in Fig. 7. This forms the variable resistance V.

An ebonite strip 8½in. x 3in. x ¼in. is drilled to take three switch arms, the first and second each with eight studs, and the third with six studs. It is essential that

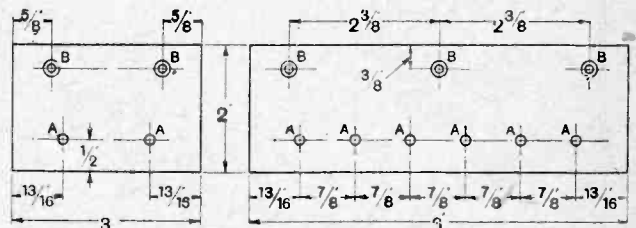

Fig. 9.—Details of terminal strips. These are cut from ¼in. ebonite and the sizes of holes are as follow: A, 5/32in. dia. for No. 4 B.A. terminals; B, ¼in. dia. and countersunk for No. 4 wood screws.

good laminated switch arms be used and that burrs be removed from the drilled ebonite before inserting the studs, and also that the studs are sufficiently close together to ensure that the switch arms do not break contact with one stud before engaging with the next.

The tapping loops are scraped clean, and short lengths of No. 36 S.W.G. D.C.C. copper wire soldered on to connect them to the appropriate studs.

The ebonite strip, together with two pieces of wood, each ¼in. x 3in. x ¼in., are assembled to form three sides of a box (see Fig. 8). The cardboard cylinder carrying the windings is fixed as shown, and the whole screwed down to the baseboard to the right of the condensers, by means of right-angled brackets.

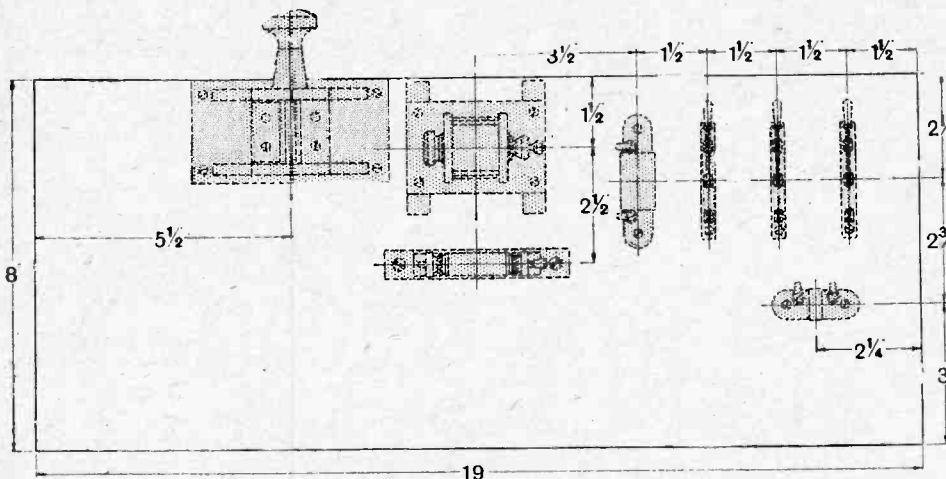

Fig. 10.—Layout of components on vertical board at back of set. Components may be identified by reference to Fig. 11.

Practical Crystal Oscillator.—

It will be found that oscillation can be controlled very successfully by these resistances, final adjustment being made with the third switch arm.

Switches.

Besides the series-parallel switch already described,

Terminals.

All components should, as far as possible, be fitted with terminals rather than soldered connections, as this enables temporary changes to be made in the circuit, should such be required in the process of experiments. Besides these connections, terminals are required for the earth, aerial, telephones, and battery connections. They

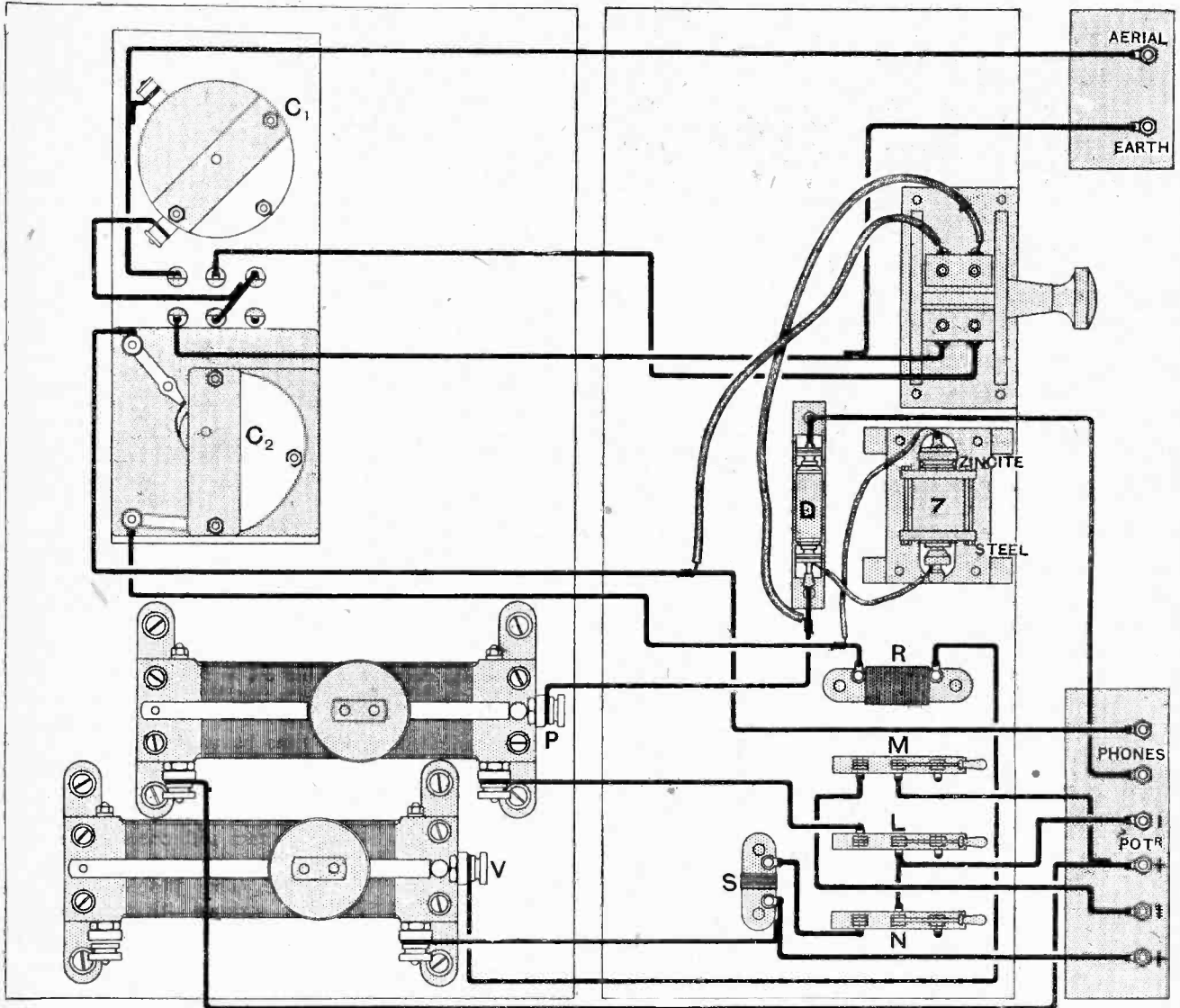

Fig. 11.—The wiring diagram. The parts are lettered to correspond with the theoretical diagram, Fig. 1.

three switches shown at I, M, and N in the circuit diagram are required.

L and M are small single-throw knife switches, mounted on ebonite, and N, which introduces the shunt S, and is only used momentarily, can be some form of simple tapping key made from a piece of springy brass strip, or, for the sake of symmetry, can be a knife switch similar to L and M.

The positions of these three switches are given in Fig. 10.

B 8

are arranged on $\frac{1}{4}$ in. ebonite at the top of the vertical back of the set—the aerial and earth terminals to the left of the coil holder, and the remainder above the switches.

Suitable dimensions for the terminal strips are given in Fig. 9. The terminals should be appropriately marked "Aerial," "Earth," "Phones," "Potentiometer," and + and -, as indicated in Fig. 11.

Batteries.

Only four flashlamp batteries are required, there being

15

Practical Crystal Oscillator.—

no necessity for accumulators, as normally the maximum current does not exceed 3 or 4 milliamps. One battery is connected to the two terminals marked "Potentiometer," and the remaining three batteries are in series and connected to the two other terminals marked + and -. When the voltage of these three batteries has fallen to

zincite of the crystal booster is connected to the positive pole of the battery, and the steel contact to the negative.

Wiring and Testing.

Wiring up is carried out in accordance with Fig. 11 in the usual manner with bare tinned copper wire of No. 16 S.W.G., except in the cases of the movable plug of the coil holder, and the crystal booster, where light rubber-covered flex is used.

This should present no difficulty, and the only necessary test is to ascertain smooth working of the potentiometer and variable resistance. This test is performed by donning the headphones, which should be of high resistance (4,000 to 8,000 ohms), and putting the two crystals of the detector into contact (not necessarily at a "sensitive" point); the steel cat-whisker and the zincite of the crystal booster are placed *out* of contact with each other, and the condenser C_2 is temporarily shorted. No coils are fixed in the coil holder. The whole or part of the battery is connected up to its proper terminals, and the switches I. and M closed.

On moving the sliders of the rheostats (or the switch arms in the alternative arrangement), the absence of loud clicks will indicate that the moving contacts are in good order.

10 or 11 volts, it may be found necessary to connect up a fourth in series with them.

Particular attention must be paid to polarity, as stable oscillation is much more readily established when the

position, and the switch I. opened, followed by the switch M; in each case a loud click will be heard in the telephones if the wiring is correct.

(To be concluded.)

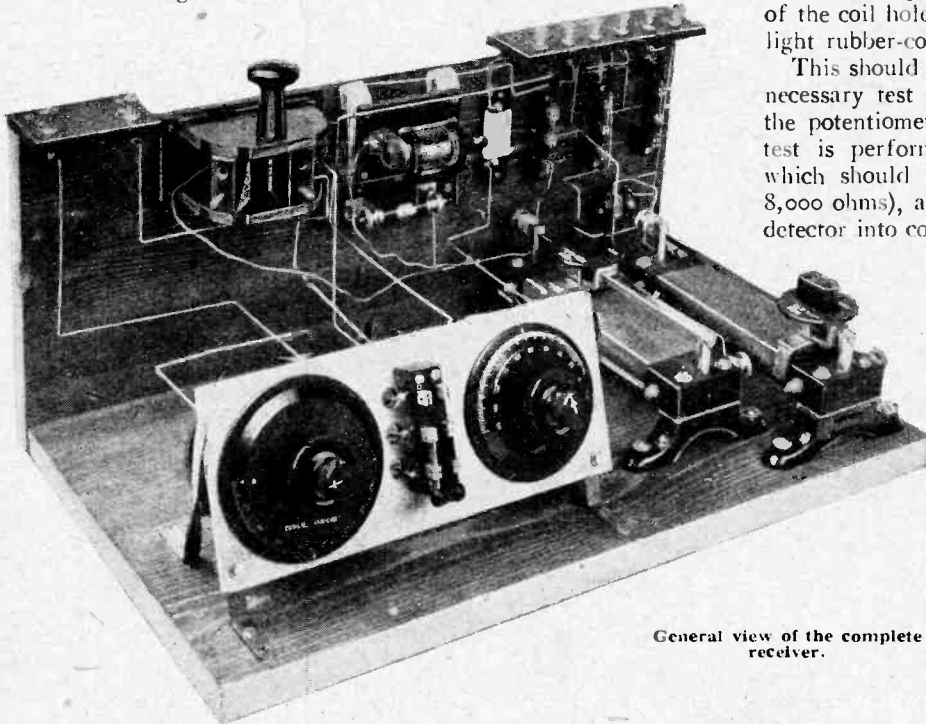

General view of the complete receiver.

ARTILLERY CONTROL BY WIRELESS.

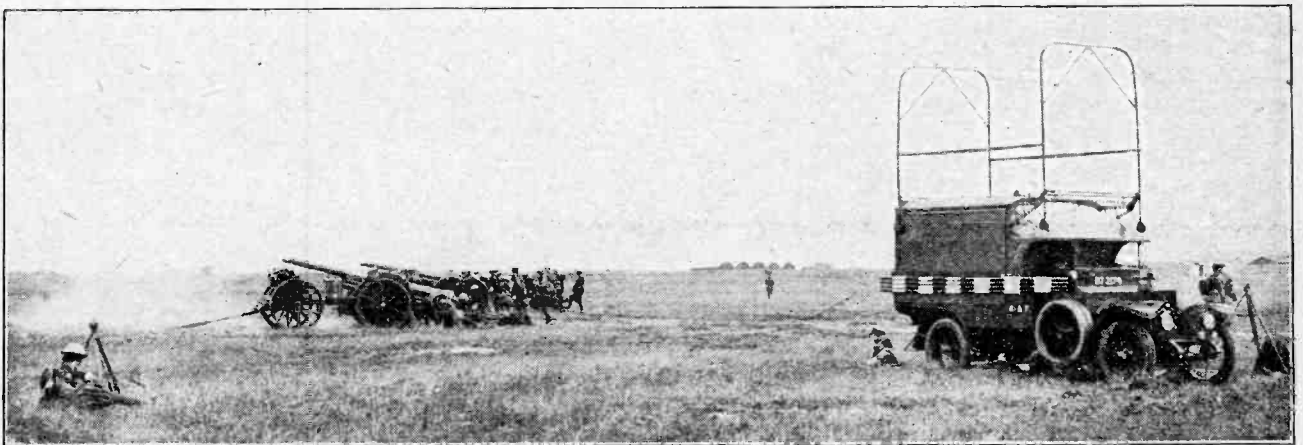

Wireless is being extensively used during the army manœuvres. One of the mobile wireless stations for communication between the observing aeroplanes and the guns can be seen in the photograph.

AMATEUR TELEPHONY RECORD.

2NM's Voice Heard in New Zealand.

TELEPHONY with the Antipodes is the new record established by Mr. Gerald Marcuse (2NM), of Caterham, Surrey. On eight consecutive mornings Mr. Marcuse has conversed by wireless telephony on 45 metres with Mr. F. H. Schnell, who is at present in charge of the short-wave experimental equipment on board the U.S.S. "Seattle," in Wellington Harbour, New Zealand. Mr. Schnell replied in Morse.

The story of how Mr. Marcuse came to venture upon telephony tests with a vessel "down under" is one of exceptional interest. Encouraged by reports from all parts of the world on his 90-metre transmissions, and requests from New Zealand and Australia "to try telephony," 2NM determined to instal the necessary gear. Although presenting several difficulties on 45 metres, it was decided to make use of a master drive. An equally important question was the choice of a suitable aerial, and after many experiments with different types, a decision was made, and never regretted, in favour of the Hertz antenna and radio frequency feeder.

The first practical telephony tests were made in co-operation with 1DH in Mosul. Excellent results were obtained at night, and the success was repeated in daylight, every word being received clearly. Shortly afterwards, Mr. Schnell, on board the "Seattle," then 400 miles east of Sydney, called up 2NM and invited him to try telephony. The new apparatus was put into action, and in spite of heavy atmospheric disturbance, Mr. Schnell reported reception of most of the speech as O.K. When the "Seattle" arrived in Wellington Harbour even better results were obtained. An amusing feature of the tests was the incredulity of the "Seattle's" commander, Captain Crosse, who at first regarded the affair as a joke on the part of a New Zealand amateur. He was subsequently convinced!

Perhaps the most important observation made was the absence of any night distortion, despite the low wavelength. It was noted, however, that the best results were forthcoming when both stations were in bright sunlight.

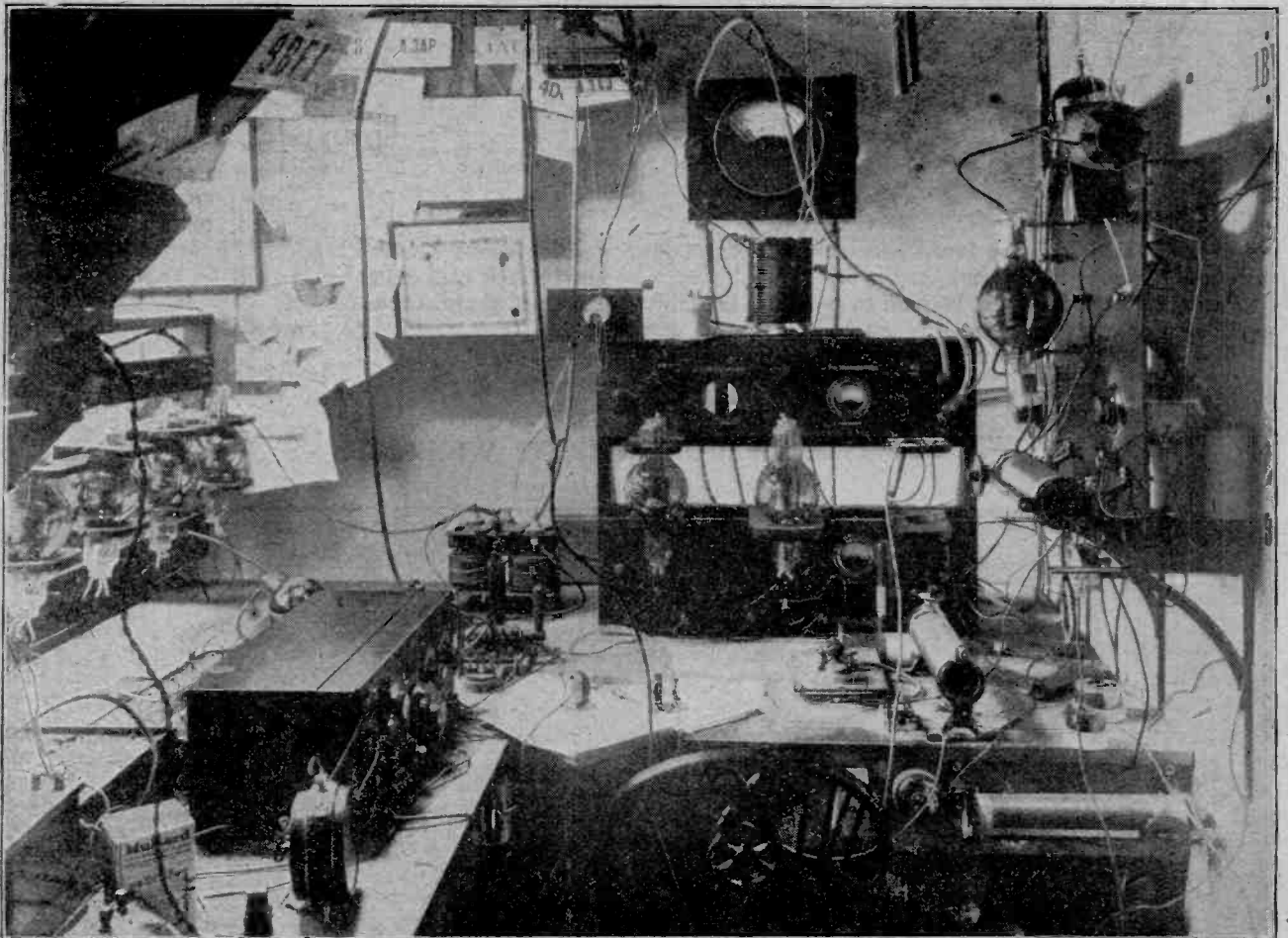

TELEPHONY WITH THE ANTIPODES. A new photograph of the telephony transmitter and receiving apparatus at G2NM, owned and operated by Mr. Gerald Marcuse, whose feat in communicating by telephony with New Zealand has created a new amateur record.

WORLD'S LARGEST BROADCASTING STATION

The equipment is described of the new "super-power" American broadcasting station WGY. An input of 50 kilowatts, twice the ultimate power of Daventry, and on a wavelength of 379 metres, brings the station within fairly easy reception of broadcast listeners in this country when using multivalve sets. Experimental transmissions have already commenced.

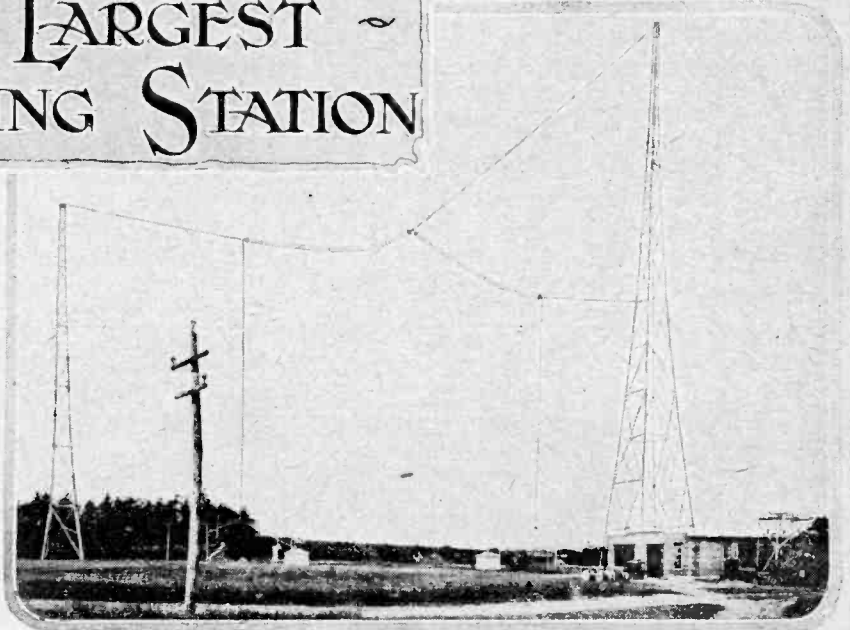

ON a site near Schenectady in the United States a radio development laboratory for research on wavelengths from 5 to 3,000 metres and with power from 5 watts to 100 kW. has been constructed. In view of the meagre data at present available relating to telephony transmission as applied to broadcasting, the General Electric Company of America intend to undertake a systematic study of transmission phenomena, and in the solution of existing defects in broadcasting will investigate the suitability of short waves and long waves on low and intermediate powers. It is obvious that the use of a high power station in providing increased energy at the receiver will raise the level of signal strength above

noise, and should to some extent tend to decrease the effect of static and other disturbances.

The principal work, however, is the development of a "super" high power station operating with a normal input of 50 kW. which is many times more powerful than anything yet attempted. This is undoubtedly the largest and most powerful broadcast transmitting equipment in the world.

The Aerial System.

To facilitate experimental work with various aerial systems, three steel towers, two of which are shown in the accompanying illustration, each 300 feet in height, are arranged in the form of a triangle so that many different types of aeriels can be erected. A fourth steel tower, 150 feet in height, is available for smaller aerial structures, while two 80 foot masts are used to carry the aeriels of a short wave set and are constructed of wood. The normal wavelength for short wave working is 109 metres.

Transmitting Equipment.

The largest of the four station buildings houses the power equipment, high voltage rectifiers and modulating equipment for the station. There are three rectifying sets, each having a capacity of 150 kW. at



The modulating equipment. The three panels on the left each carry a group of 20 kW. water-cooled valves. The low frequency amplifier panels can be seen on the right.

World's Largest Broadcasting Station.—

15,000 volts for plate current supply. The modulating apparatus may be connected with any of the smaller buildings by means of overhead transmission lines so that speech and music obtained from the studio at WGY may be caused to operate any of the transmitting equipments. An unusual provision is the inclusion of a dark room in the main building for developing oscillograph films recording modulation. The valves on the high power set are water-cooled, the water circulation being maintained by a pump having a capacity of 150 gallons per minute. A water circulating system is available also in the smaller buildings, and is connected by underground pipe lines

The filaments of all valves are heated by D.C. derived from generators of 300 and 1,000 amperes capacity at a potential of 33 volts. These machines are constructed for a minimum ripple. Two high power experimental transmitters are already in operation, one operating with a power of 50 kW. on a wavelength of 379.5 metres (WGY and 2XAG), and the other employing 40 kW. on a wavelength of 1,560 metres (2XAH).

Local Interference.

Some apprehension has been felt by the Department of Commerce as to the use of these appreciably higher powers for broadcasting in view of interference by

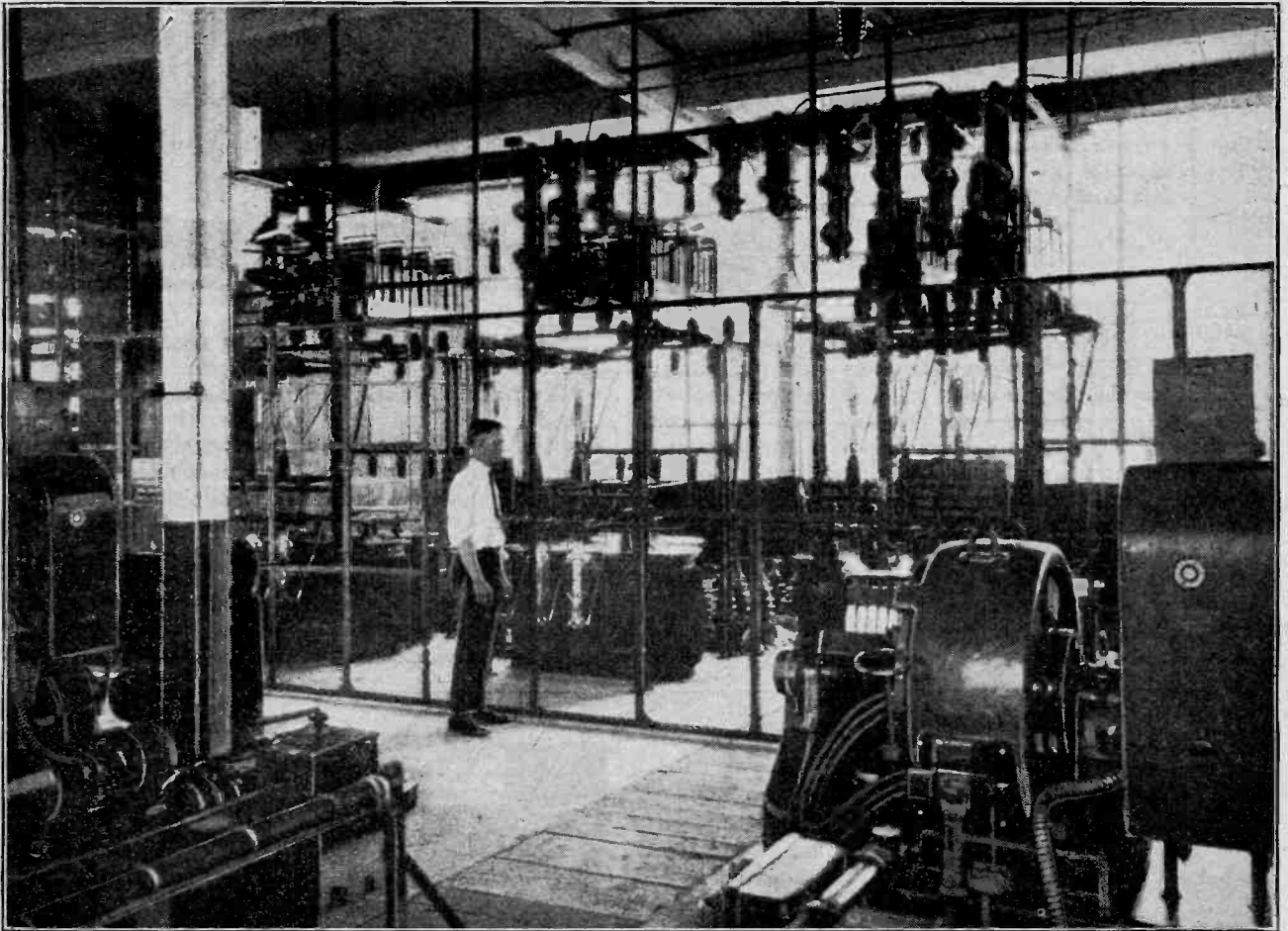

The power rectifying equipment. The generator on the right is for filament heating of the rectifier valves, and has a capacity of 1,000 amps at 33 volts.

which incidentally provide an excellent means for cooling the water. Cooling is also facilitated by means of a tubular radiator and air draught.

Plate voltage supply is obtainable from a 12,000 volt D.C. generator in addition to the rectifiers already mentioned, though the D.C. machine is available essentially for supplying the master oscillator valves and other low power equipment. Generators supplying 4,000 volts and 2,500 volts are used for plate current supply of the smaller valves.

jamming, particularly in the immediate vicinity of the transmitting stations. It is for this reason that the experimental equipments are located several miles from the city of Schenectady, so that the intense field in the immediate locality will not interfere with the reception of other programmes in the densely populated area of the town. It is this consideration which probably caused the B.B.C. in this country to build the high power Daventry Station in a rural district instead of in the vicinity of one of the larger towns in the Midlands.

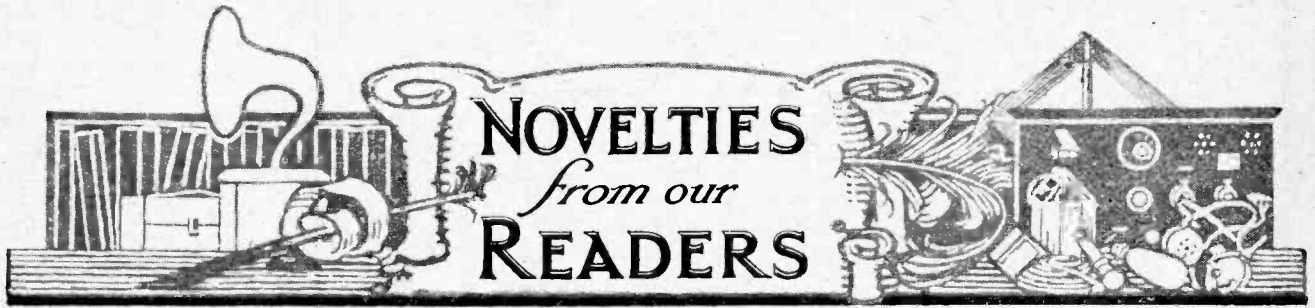

A Section Devoted to New Ideas and Practical Devices.

TRIP RELAY.

THE relay is fitted with two distinct windings; the operating coil O and the retaining coil R. Coil O is of high resistance and is included in the receiving circuit. When a current is passed, the contacts T and M are closed and current from a local battery energises the coil R and breaks the circuit between T and B until the circuit is broken by depressing K. Thus a transient current in O will open the contacts T and B until the local battery is exhausted. A buzzer or lamp X may be connected in the local circuit to indicate when the relay is open.

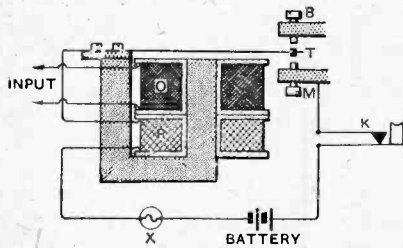

Trip relay, suitable for use with automatic call devices.

The relay is capable of numerous applications. For instance, it could be used in conjunction with the call device described in the issue of this journal of June 10th, 1925, or the protection device for a Weston relay mentioned on page 278 of the issue of April 8th, 1925.—P. J. P.

○○○○

CRYSTAL DETECTOR IMPROVEMENT.

There are many crystal detectors in which the universal joint consists of a solid ball with a projecting sleeve slotted to give an even pressure to the sliding rod carrying the cat-whisker. In time the rod works loose and it becomes necessary to dismantle the detector in order to squeeze up the sleeve and renew the pressure on the rod.

10

Detectors of this type may be greatly improved by cutting off the

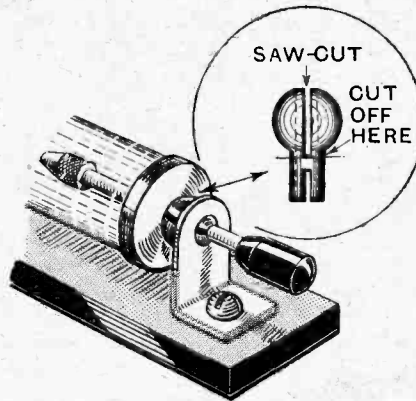

Self-adjusting ball joint in a crystal detector.

projecting sleeve after making a saw cut in the ball along the axis of the centre hole. The saw cut in the ball must be made before cutting off the sleeve, otherwise difficulty will be experienced in holding the ball in the vice. The two halves are then re-assembled in the detector on either side of the adjusting rod, when it will be apparent that the brass retaining spring will automatically keep the pressure equalised and give a smooth action to the adjustment of the cat-whisker.—C. T. W.

○○○○

LOW CAPACITY VALVE HOLDER.

Ordinary four-pin valves can be used for short wave reception provided that a mounting is used which

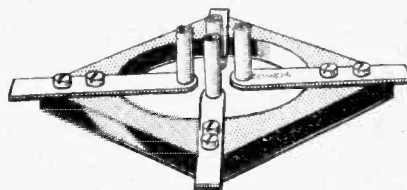

Valve holder for use with four-pin valves on short wavelengths.

gives high insulation and a low capacity between the connections. An excellent design fulfilling these conditions is given in the diagram.

A circular hole about 1 1/2 in. diameter is cut in a piece of ebonite 2 in. square and 1/4 in. thick. The valve sockets, which may be shortened if desired, are fitted to the ends of four flat strips of hard-rolled brass, 1 1/2 in. x 1/16 in. x 1/16 in. The strips are then screwed to the corners of the ebonite base after marking the position of the screw holes with a valve inserted in the sockets. Finally, leads are soldered to the ends of strips which project to form tags.—A. R. W.

○○○○

NON-MICROPHONIC VALVE MOUNTING.

The valves in receivers fitted with ordinary valve holders may be isolated at least from violent mechanical

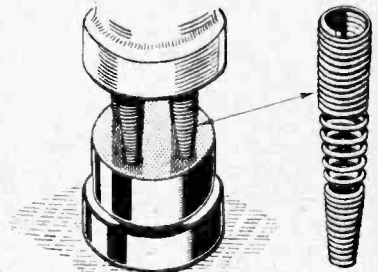

Coil springs used to protect valves from mechanical shocks.

shocks by fitting tapered coil springs over the valve legs before they are inserted. The springs may be wound with hard-drawn brass wire on the point of a knitting needle or on a mandrel specially tapered for the purpose. Due allowance must be made in the diameter of the mandrel for expansion of the coil when it is released. Before fitting to the valve legs, a few turns in the centre of the

B 15

coil are pulled out to prevent transmission of longitudinal vibrations through contact between the coils.—A. C. D.

○○○○

TELEPHONE PLUG CONNECTIONS.

Several pairs of telephones may be connected in parallel with a single telephone plug by means of the terminal device illustrated in the diagram.

A strip of $\frac{1}{4}$ in. or $\frac{3}{8}$ in. ebonite bolted to the end of the plug carries two terminal heads into which the tag

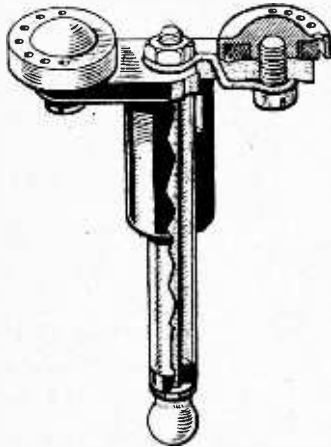

Multiple terminals for telephone plug connections.

connections of the telephones are forced. An annular ring on the under side of each terminal head contains a rubber ring which forces the tags against the sides of the small holes, thus making a firm and silent contact. One terminal head is connected to the ball contact on the plug and the other to the sleeve.—W. F.

○○○○

COIL TAPPINGS.

Instead of using twisted loop connections in conjunction with a radial switch to tap a cylindrical inductance coil, it is convenient to make use of "Clix" terminals or plugs and sockets of similar design.

Before winding the coil, holes are drilled in the former at suitable intervals to take the sockets, which are held on the inside with a lock-nut. The lock-nuts are not finally tightened up until the winding of the coil has been completed. In winding the coil, the insulation is bared for a short distance at each tapping point, and a single turn is taken round the socket which may then be tightened up. The plugs are attached to flexible wires so

that tappings may be taken from any part of the coil. The method should be particularly useful in building inductances for transmitters with a power input of not more than 10 watts.—W. H. D.

○○○○

CUTTING SMALL SCREWS.

It is difficult to hold screws in the vice without damaging the thread, and, if held by the head, there is not enough surface to prevent the screw from twisting round under the weight of the saw.

A practical solution of the difficulty is to make saw cuts in two large nuts of the same thread and to thread these on to the upper portion of the screw. The nuts are held in the vice with the saw cuts uppermost, and grip the screw firmly without in the least damaging the screw thread. Further, the burr left by the saw will be removed when the nuts are taken off the screw.—G. E. M.

○○○○

MULTI-LAYER COIL FORMER.

The process of removing a multi-layer coil from its former is considerably simplified if the centre piece is built up from three discs. Before winding the coil a section of cardboard tube about $\frac{3}{8}$ in. in width is slipped over the plain centre section of the former. The two outer discs are then placed in position and the

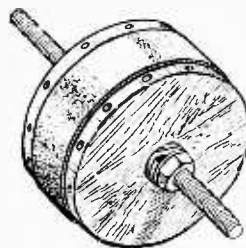

Sectional former for winding multi-layer coils.

spokes inserted. It will be, at once apparent that the spokes may be staggered or set in line according to the type of coil which it is required to produce. When the coil is finished, the pegs and the two outer discs are removed, when the centre disc can be quite easily removed without disturbing the winding.—A. W. E.

○○○○

PREPARING SPACING STRIPS.

In one form of spacing strip used in the construction of frame aerials and air-spaced coils, grooves are cut

with a hack-saw at regular intervals to support the turns in the winding. If the strips are marked out with dividers and then cut by hand with the saw, it will be difficult to make each cut exactly on the line, while there is always the possibility that a false start will spoil the appearance of the finished coil. The specially shaped gauge shown in the diagram greatly simplifies the cutting of the slots, as it ensures equal spacing and acts also as a guide which minimises the chance of a false start.

A short piece of square brass rod is filed down at one end, leaving a

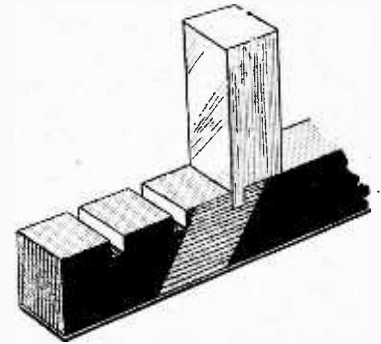

Gauge for slotting spacing strips.

tongue along one edge equal in thickness to the width of a saw cut. The first slot is cut by hand after marking off with a square. The gauge is then inserted, and the next slot cut with the saw pressing against the right-hand face of the gauge, and so on. A line scribed across the right-hand face to coincide with the upper edge of the saw blade will enable the slots to be cut to a uniform depth.—F. R.

○○○○

GRID LEAK CLIPS.

The amateur whose workshop facilities are limited to a pair of pliers, a hand drill, and a corner of the kitchen table may find the following hint of value when looking for a convenient method of mounting a grid leak.

Obtain a laminated switch arm, and, after filing off the heads of the rivets, separate the leaves with a pen-knife. Two of these are selected for the grid leak clips and bent at right angles. The hole originally intended for the switch arm serves to screw the clips to a suitable base, while the rivet holes will fit the pointed caps on the grid leak when it is inserted.—A. M.

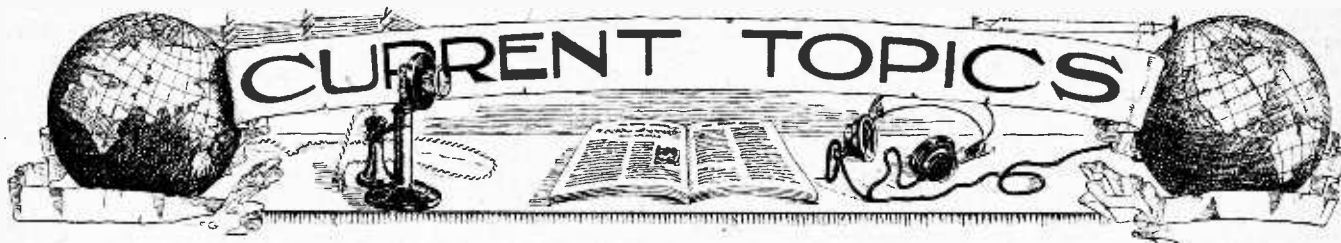

Events of the Week in Brief Review.

ANOTHER AUSTRIAN BROADCASTING STATION.

A five-kilowatt broadcasting station is to be opened in October at Rosenlügen, near Vienna.

o o o o

LORD MAYOR'S LOUD SPEAKERS.

Six loud speakers have been installed in the Egyptian Hall at the Mansion House. The use of loud speakers is stated to have made an enormous difference to the acoustics, and whereas it has hitherto been almost impossible to hear a speaker in certain parts of the hall, people unable to gain admittance can now hear clearly from the outside.

o o o o

SEISMOGRAPH AND WIRELESS.

The automatic wireless transmission of the movements of the seismograph is made possible by a new invention developed by Professor Shida, of the Kyoto University. By its means, the outside world would receive instant news of an earthquake, and a distant alarm could be spread over an immense region outside the danger area.

o o o o

HONG KONG HEARD IN I.O.W.

With a single-valve modified Reinartz receiver Mr. J. C. Everett, of Yarmouth, Isle of Wight, picked up a Hong Kong amateur, XAI, on August 17th. XAI, who was transmitting a CQ call on 40 metres, gave his identity as Mr. Tang-fong Laum, Man Chuu Tai, 35, Con-naught Road West, Hong Kong, China.

o o o o

NEW SPANISH BROADCASTING STATION.

Very shortly transmissions are to begin from a broadcasting station now under erection at San Sebastian. Using the call-sign EAJB, the new station will operate on a wavelength between 390 and 425 metres.

o o o o

WORLD WIRELESS CONFERENCE.

An International Radio Conference is to be held in the United States next spring, states a Washington message. The State Department has sent invitations to 42 foreign Governments to attend.

It is understood that the Conference will discuss the revision of the International Radio Convention of 1912, measures for the increased supervision of broadcasting, the handling of Press messages, radio telephony, and the elimination of interference.

NIL DESPERANDUM

In view of the recent epidemic of reception of Chilian amateurs, including 1EG, a letter just received by *The Wireless World* from Mr. E. Guevara, owner of that station, is of special interest. The letter is dated July 19th, and in the course of his remarks Mr. Guevara laments the fact that, although he has exchanged signals with a vessel off China, and listened to American and Australian amateurs, he has failed to hear anything from England.

Reports go to show that within ten days after the dispatch of this letter, Mr. Guevara had not only received British amateurs but had worked with them!

Communications intended for Chilian 1EG may be forwarded c/o Mr. Luis Guevara, 118, Duchy Road, Harrogate.

o o o o

ENTHUSIASM IN INDIA.

The formation of an Amateur Radio Relay League for India is undergoing serious consideration, according to an Indian correspondent. The Radio Club of Madras has had gratifying success with a small transmitting plant. With an input of not more than ten watts the station has been heard at a distance of two hundred miles.

Among the listening amateurs great enthusiasm centres round KDKA's short wave transmissions.

TRACKING AN OFFENDER.

On many recent occasions when the good folk of La Crosse, Wisconsin, were reveling in the reception of a particularly fine broadcast concert a noise "resembling a trip hammer" cut short their enjoyment.

When human endurance had been tested to the uttermost, the La Crosse Radio Association, affiliated with the American Relay League, organised a vigilance committee, which proceeded on a ruthless search after the offender. Twelve city blocks were covered with a directional receiver, without result.

Finally the trouble was traced to a badly insulated arc lamp.

o o o o

A RENEWED ACQUAINTANCE.

More than usual interest attaches to the report of Mr. J. E. Simmonds (20D) that he exchanged signals on 45 metres with Z1AX on August 26th. Z1AX is owned and operated by Mr. Jack Orbell (ex-3AA), who happened to be on a visit to this country at the time when two-way communication was first established between British and New Zealand amateurs.

Mr. Orbell stated that this was his first communication with Great Britain since his return. It will be remembered that he contributed an article to *The Wireless World* dealing with the first exchange

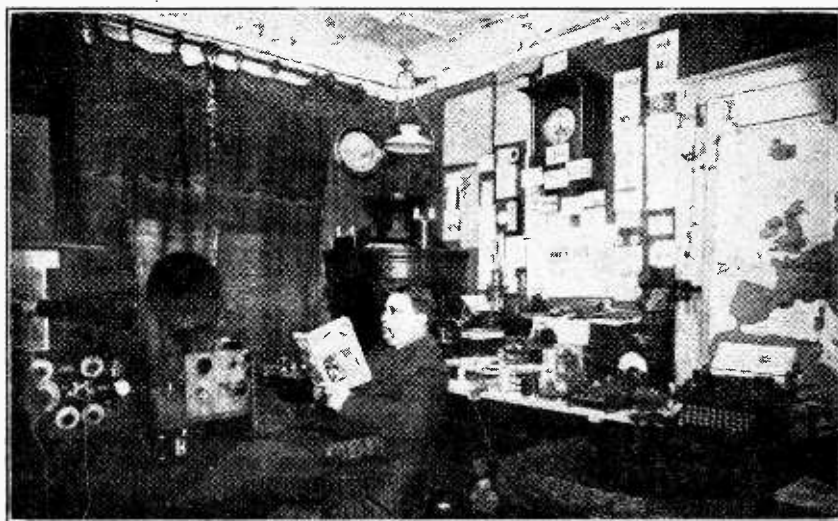

A GERMAN AMATEUR TRANSMITTER. One of the most prominent of the German transmitting amateurs is Herr Rolf Formis (KY4), of Stuttgart, who is here seen in his operating room. Note the QSL cards from British, French, Spanish, and other European transmitters.

of signals between Great Britain and New Zealand

Using the low wavelength of 23 metres, Mr. E. J. Simmonds has established two-way communication with AF1 of Buenos Aires. Mr. Simmonds reports that he is maintaining regular schedules with Australian 2CM; moreover, he succeeded on August 15th in exchanging signals with the U.S. destroyer "Litchfield" (NUMM), at Christchurch Harbour, New Zealand.

A report has reached Mr. Simmonds from Capetown, South Africa, stating that his signals on 25 metres have been received by Mr. Oxenham (A4L).

○○○○

RUSSIAN TRANSMITTER HEARD IN INDIA.

Calling CQ, a Russian station with the call-sign RDW has been heard on 80 metres by Sgt. M. H. Figg, at present in the Punjab. RDW is the station of the Radio Laboratory at Nijni Novgorod. The signals strength was R7 on a two-valve (0-v-1) receiver.

○○○○

THE HOUR RECORD ?

Mr. F. J. Taylor, of Birmingham, reports that in a single hour, from 6.30 to 7.30 a.m., on August 16th he picked up signals from the following:—Argentine CB8, New Zealand 4AK, Australian



NEW ZEALAND IAX. A view of Mr. Orbell's aerial at Christchurch, New Zealand.

B 18

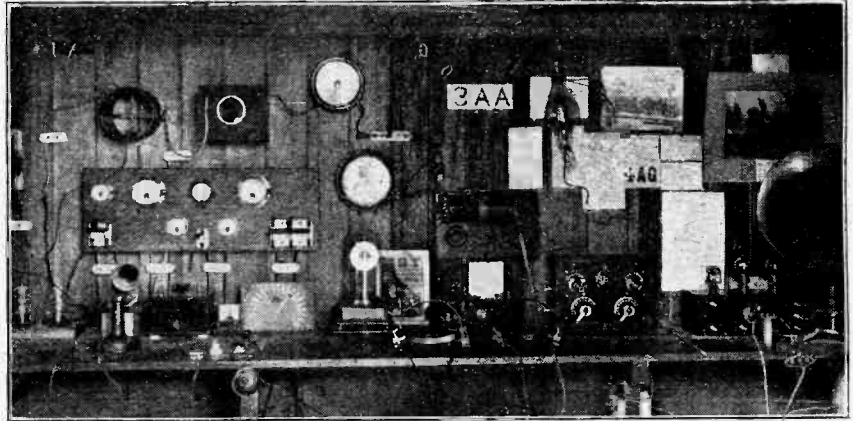

NEW ZEALAND IAX. The transmitting equipment of Mr. Jack Orbell (ex 3AA), of Christchurch, who has established two-way communication with Mr. E. J. Simmonds, G2OD, of Gerrard's Cross. It will be remembered that Mr. Orbell was on a visit to this country at the time when communication was first established with New Zealand.

5BQ, Mexican 1B, and NRRL in the Pacific Ocean.

He asks if this is a record "DX tour" for such a short space of time.

○○○○

FOG—PHYSICAL AND MENTAL.

Captain F. C. Barnard, the well-known Imperial Airways pilot, recently flew an air express from Paris to London above the clouds without once seeing the ground. After landing at Croydon a mystified group of passengers plied him with questions as to how he managed to find his way. They remained dubious after Captain Barnard had explained that the Croydon wireless operators supplied him with bearings at regular intervals throughout the journey.

○○○○

WIRELESS SERVICE TO JAPAN.

A new wireless service to Japan has been inaugurated by Marconi's Wireless Telegraph Co., Ltd., and is now available to the public. The rate for this service is 3s. 4d. per word.

○○○○

TELEPHONES FOR BRITISH TRAINS?

Following upon the installation of wireless telephones in German trains, it is interesting to note that investigations upon the possibility of introducing such a system on British lines are being renewed by the London, Midland & Scottish Railway.

Successful experiments with wireless telegraphy were made many years ago, but as a wireless telegraph service for trains had no practical value the matter was not proceeded with. Wireless telephony, of course, suggests really useful possibilities. The Chief General Superintendent of the L.M.S. will probably cross to Germany shortly to make a personal inspection of the methods in use on the Berlin-Hamburg line.

A difficulty confronting the British engineer, but not arising to any great extent on the German railways, is caused by the fact that the telegraph wires in this country do not always run parallel

to the line and in many cases become covered cables, so that they cannot be used as conveyors for inductive reception.

○○○○

BELGIAN AND IRISH DX.

The first two-way communication between Belgium and Ireland has been accomplished by Belgian 4RS, of Verriers, and Mr. F. R. Neill (G5NJ), of Whitehead, Co. Antrim. The stations exchanged signals on August 9th.

○○○○

PRINTING BY WIRELESS.

Considerable public interest has been aroused by the announcement of details concerning a new printing machine which dispenses with metal type, substituting for it a photographic film bearing the printed characters. By means of a keyboard operated like a typewriter, letters and characters from a "master film" are projected one by one in rapid sequence on to a sensitised photographic film base, the exposure being made in a fraction of a second.

The use of wireless in connection with such a machine does not appear impracticable to the inventors, Messrs. J. R. C. August and Mr. E. K. Hunter, who express the opinion that wireless would enable a machine installed in, say, a London printing works, to "set up" the same matter simultaneously in many provincial towns.

○○○○

BOOKS RECEIVED.

Readable School Electricity. By Vivian T. Saunders, M.A., Assistant Master at Uppingham School. 176 pages, 8 plates, 92 figures. Price 2s. 6d. (London: G. Bell and Sons, Ltd.)

Loughborough College Calendar, Session 1925-26, containing general information for the admission of students, college regulations, and syllabus of instruction in the Faculties of Engineering, Pure and Applied Science, Extra-Mural Adult Education, Junior College for Boys, School of Industrial and Fine Art, Sports Clubs, Radio Society, etc., published by the Echo Press, Loughborough, Leicestershire.

SINGLE VALVE BROADCAST RECEIVER

Wavelength
Range
300=550
and
1,000=2,000
Metres.

By
A. R. TURPIN.



The tuning condenser rotates through 360 degrees and automatically short-circuits a long-wave load coil throughout one half of its movement.

THE set about to be described was designed with simplicity of control and neatness as the outstanding features, but at the same time the efficiency of the set had to be kept as high as possible, as it was to be installed thirty miles north-west of London and used with an indoor aerial.

There are two rather unique points about the set. The first is the method of making the self-supporting coils, and the second the way in which the loading coil is short-circuited when not in use.

The Circuit

The complete circuit is shown in Fig. 1. The large-capacity condenser across the high-tension battery is shown dotted because this is not absolutely necessary, but may improve reception if the battery is of high resistance or is getting old.

A small condenser having a fixed capacity of about 0.0001 mfd. is placed in series with the aerial in order

to decrease the damping and improve selectivity. The condenser actually used in the set was built up on the aerial terminal itself in the manner indicated on page 113 of *The Wireless World* of July 22nd, 1925, but a fixed mica condenser of standard design would be fitted if desired. The value of 0.0001 mfd. was arrived at as the result of a series of experiments to determine the lowest value that could be used without detriment to the strength of signals on the 1,600-metre wavelength.

The A.T.I. consists of two parts—the short-wave winding to which the reaction coil is coupled, and a load coil to bring the wavelength up to 1,600 metres. An automatic switch operated by the tuning condenser short-circuits the load coil when it is required to receive stations between 300 and 500 metres.

The filament current is controlled by an "on and off" switch in the negative lead, and a fixed resistance in the positive lead.

Construction of Components.

The first component to construct is the variocoupler. This consists of a reaction rotor which is a wooden ball 3½ in. in diameter wound with about 55 turns of No. 20 S.W.G. D.C.C. wire. One end of the wire is joined to a 2 B.A. spindle, and the other to a 4 B.A. cheese-head screw.

The low-wave aerial coil is in two sections, each of which may consist of about 18 turns of No. 20 or 22 S.W.G. D.C.C. wire. In the set illustrated, one section consists of 20 turns, and the other 14, the larger coil being found necessary to tune up to the required wavelength after the set had been assembled. These coils can be wound on an ordinary jam jar of the required diameter (3¾ in.) over strips of adhesive tape the ends of

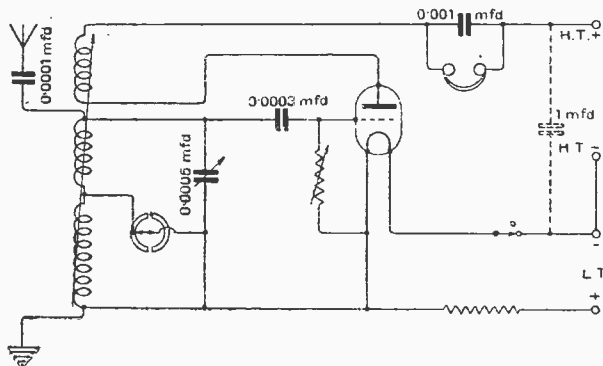

Fig. 1.—The circuit diagram.

Single Valve Broadcast Receiver.—

which are bound back over the coil when completed to hold the turns in position. If the turns do not slide off easily, the jar may be broken to free the coils. Another method of winding these coils is to do so slightly diagonally on an ordinary former. When completed, the turns

removed and the ends taken to two No. 6 B.A. screws in a strip of ebonite, which clamps the coil to the base-board. This coil is joined in series with the fixed outer windings of the vario-coupler.

Full reaction may not be obtainable with the loading coil in circuit, but sufficient will be given to receive the high-powered station over a distance of 200 miles with an outdoor aerial.

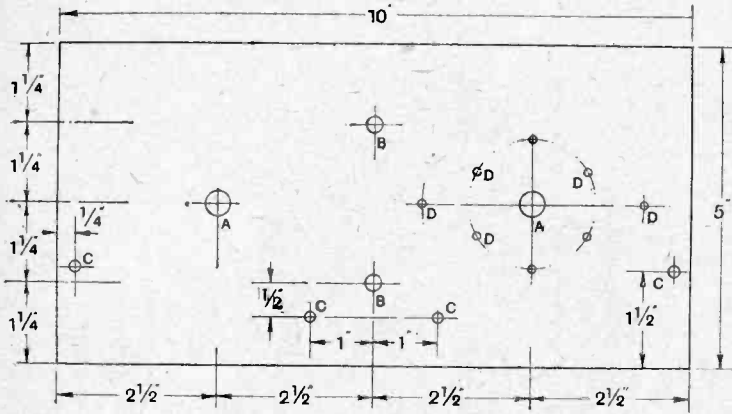

Fig. 2.—Drilling details of front panel. Sizes of holes are as follow: A, 3/8in. dia. (clearance); B, 1/4in. dia. (clearance); C, 5/32in. (4 B.A. clearance); D, 1/8in. dia. (6 B.A. clearance), countersunk on under surface of panel.

are pushed straight, so that the diameter is increased and the coils slipped off the former.

These two coils are mounted on a strip of wood screwed to the baseboard to raise them to the required height, and clamped in position by a strip of fibre. It is necessary to use fibre, which is flexible and automatically adapts itself to the shape of the windings: if ebonite were used, the rotor would foul the middle of the strip when turned vertically. When mounted, the coils should be joined in series with the direction of winding the same in each coil.

Before mounting them, it will be necessary to drill the panel, fix the various components, and place in position the rotor, which is held at one end only by the spindle passing through a brass bush, and is secured by a "Collet" dial and knob. Should it be desired, the motion of the rotor could be limited to 180 degrees by the following method. A diagonal saw-cut about 1/16 in. deep is made vertically in the end of the variometer bush, and the metal on one side of this is removed, leaving a right-angled step. A peg screwed into the side of the spindle will engage with the two flats thus formed on each side of the bush, and prevent a movement of the rotor in excess of 180 degrees. If it is decided to fit a stop of this type, it will be necessary to use a plain spindle of larger diameter than No. 2 B.A.

The Loading Coil.

The loading coil may be of any type of plug-in coil having about 150 turns. The plug is

Wavelength Range Switch.

The switch for short-circuiting the loading coil is operated automatically in such a manner that by turning the condenser dial

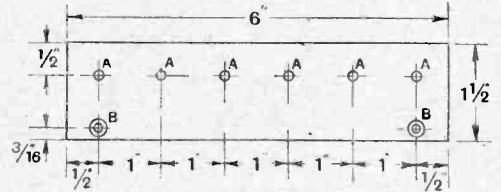

Fig. 3.—Terminal strip. Sizes of holes are as follow: A, 5/32in. (4 B.A. clearance); B, 1/8in., and countersunk for No. 4 wood screws.

through the first half-revolution, wavelengths from 300 to 550 metres are tuned in; and if this is continued for the second half, the set will receive wavelengths from 1,000-2,000 metres. Actually, one of the ranges will be reversed; thus, if the lower range increases from 300 to 550 metres with a clockwise motion of the condenser dial through 180 degrees, the upper range will start at 2,000 metres and decrease to 1,000 metres, when the

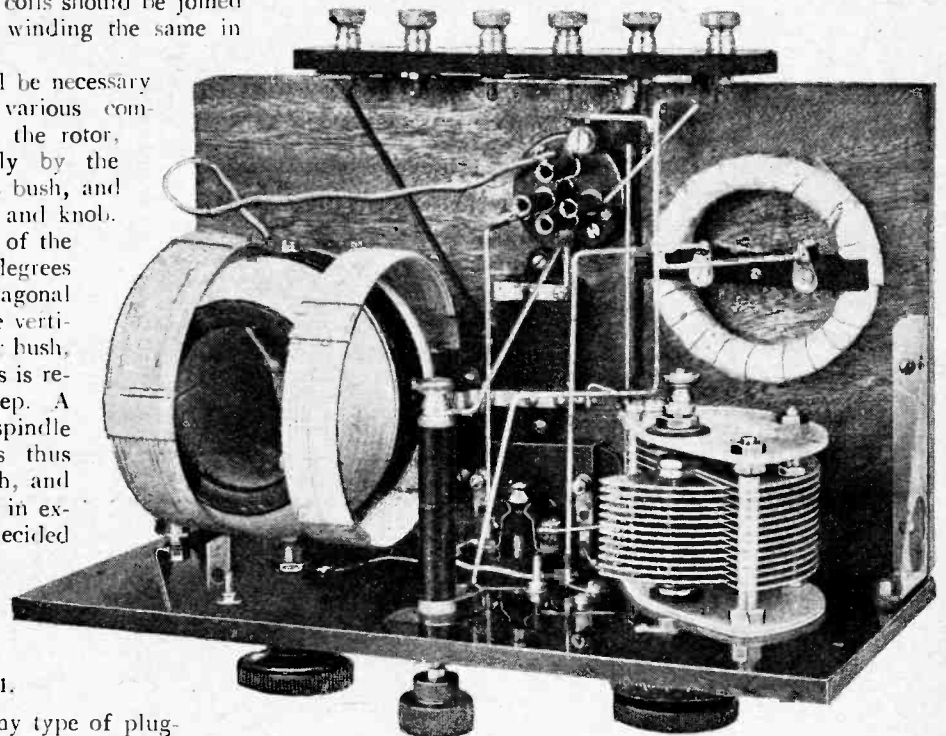

Fig. 4.—Plan view of receiver, showing variocoupler and loading coil.

Single Valve Broadcast Receiver.—

revolution has been completed in the same direction. As Daventry is the only important station that is likely to be received on the upper wavelength range, it does not much matter whether the correct setting is approached from a higher or a lower wavelength. It will be noticed that on account of the 360 degree movement of the dial, two pointers are necessary with a 180 degree scale.

Details of the range switch fitted beneath the condenser dial are given in Fig. 5. A switch arm is fixed to the spindle of the condenser which should be of a type without stops, and makes contact with two arcs screwed

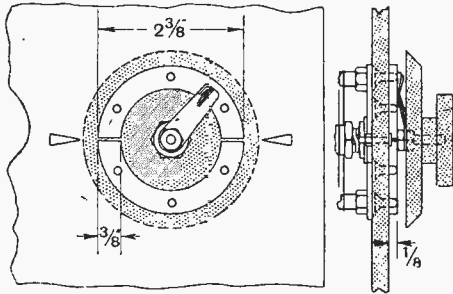

Fig. 5.—Details of switch segments.

to the panel underneath the dial. One of these brass arcs is joined to the point where the loading coil joins the low wavelength coil, so that when the switch arm is in contact with it the loading coil is shorter. The second arc is not connected in any way. The arcs, if bought, are usually supplied slightly over the half circle and about 2 1/2 in. in diameter. It will, therefore, be necessary to cut off a portion of them so that they form a complete circle with a clearance of about 1/32 in. between the two halves. If the arcs are unobtainable they may be cut from 1/8 in. brass plate with a hack saw, appearance being of second importance, as they will be eventually hidden by the dial. These arcs are screwed to the panel by countersunk screws, sunk below the surface so that they do not make contact with the condenser end plate. A cheese-head screw (S in Fig. 7) is used to make contact with the upper segment, where it does not overlap the condenser plate.

The switch arm itself should be cut down to the required radius, and the end rounded so that the full capacity of the condenser may be used.

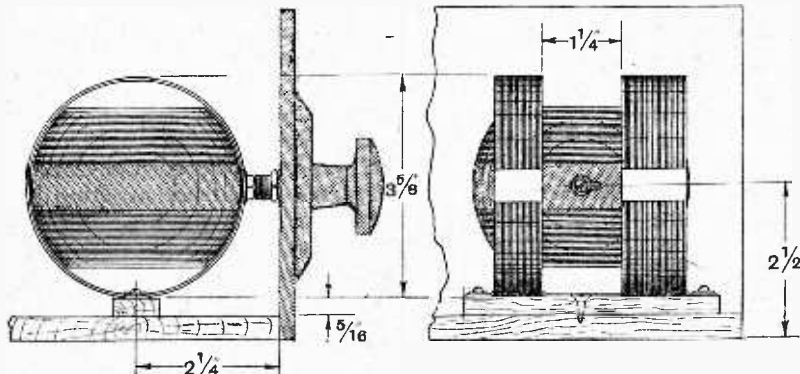

Fig. 6.—Details of variocoupler.

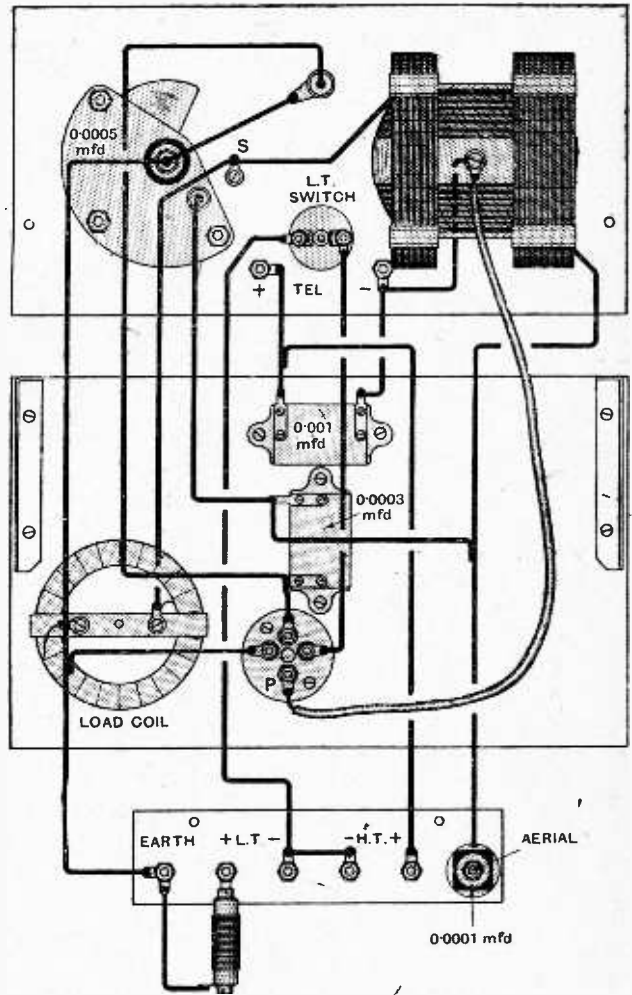

Fig. 7.—Wiring diagram. The soldering tag and screw S are in electrical contact with one of the switch segments on the front of the panel.

This arm is fixed to the spindle between two No. 2 B.A. lock nuts, and in a position so that the arm is over the point where the two arcs meet when the moving vanes are completely in or out.

Filament Control.

The writer has not included a rheostat, as this may be dispensed with without loss of efficiency providing the grid leak and H.T. voltage are correctly adjusted.

The reason a switch is used with a fixed resistance in preference to a rheostat is that the valves may easily be ruined by burning the filament too brightly. If, however, we use a switch, with a bright emitter or 0.00 type of valve, the sudden expansion and contraction of the filament when switched on may conceivably decrease its life. This drawback may be overcome by using a type of valve that does not heat above a very dull red, such as a "Weco" or "D.11" type.

The fixed resistance may either be

LIST OF COMPONENTS REQUIRED.

1 Ebonite panel, 10in. \times 5in. \times $\frac{1}{2}$ in.
 1 Ebonite terminal strip, 6in. \times $1\frac{1}{2}$ in. \times $\frac{1}{2}$ in.
 1 Baseboard, 10in. \times 6in. \times $\frac{3}{4}$ in.
 1 Variable condenser, 0.0005 mfd. (Ormond, Type No. 2).
 1 Fixed mica condenser, 0.0003 mfd. (Dubilier).
 1 Fixed mica condenser, 0.001 mfd. (Dubilier).
 1 Variable grid leak (Bretwood).
 1 Push-pull switch.

1 Valve holder for baseboard mounting.
 1 Ball former, $3\frac{1}{2}$ in. dia.
 1 Honeycomb coil, 150 turns.
 1 Cabinet (Carrington Mfg. Co., Ltd.).
 $\frac{1}{2}$ lb. No. 20 S.W.G. D.C.C. copper wire.
 Terminals (Belling Lee) for "Aerial," "Earth," "Phones,"
 L.T.+ , L.T.-- , H.T.+ and H.T.-- .
 No. 16 S.W.G. tinned copper wire, "Glazite," screws, etc.

bought, in which case it should have a value of 4 ohms, or constructed by winding 40in. of silk-covered No. 28 S.W.G. Eureka wire on to a short length of ebonite tube

baked and shellac varnished, may now be joined to the panel by the brackets and the other components mounted in the positions shown in Fig. 7 and in the photographs, the terminal strip being held flush with the back by spacing off the baseboard with condenser washers.

The wiring may now be proceeded with, and is carried out with "Glazite" or bare wire, except the connection to the outer end of the rotor, which is rubber-covered flex. The method of joining the condenser and switch is as follows: Grid side of aerial coil to fixed plates; centre point where loading coil joins main coil to one arc; moving plates to other end of loading coil.

Testing.

The connections of grid leak return may be tried at various points, but the writer found the best position to be between the grid condenser and earth, joined to L.T. plus.

In testing the set it may be necessary to reverse the connections of the reaction rotor in order to obtain an increase of reaction when the dial is turned in a clockwise direction.

The set is admirably suited to the needs of non-technical listeners, for, with the reaction and grid leak controls set, the only controls which need be touched to receive Daventry or one or more of the short wave broadcasting stations are the right-hand tuning dial and the filament switch.

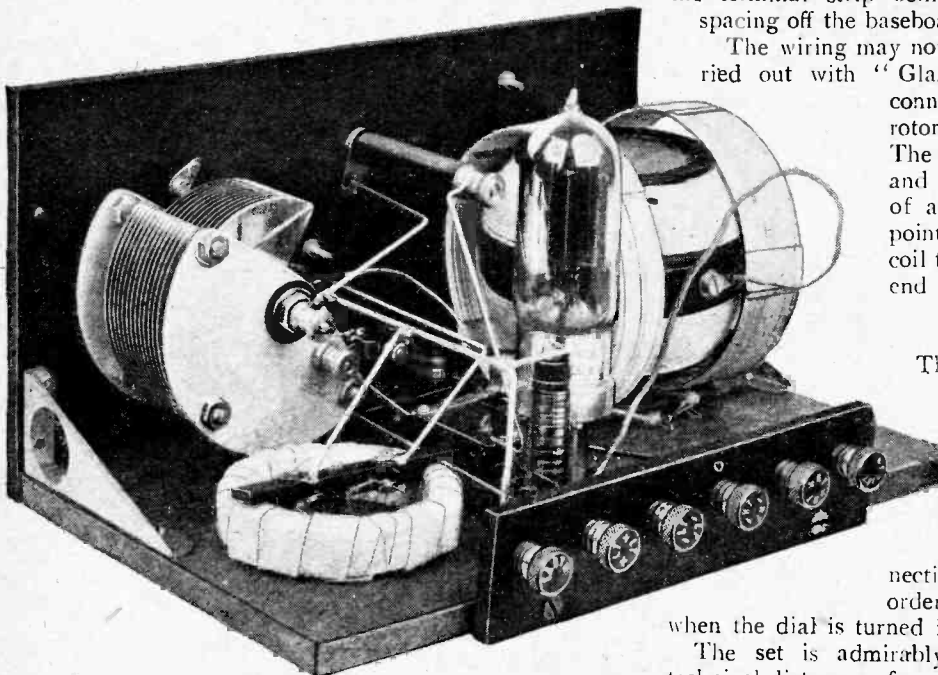

Fig. 8.—General view of the finished receiver.

$\frac{1}{2}$ in. in diameter, the ends of the wire being held by screws in the ends of the tube.

The baseboard, which should have been thoroughly

AMERICAN WIRELESS AMATEURS IN CONFERENCE.

THE Third International Convention of the American Radio Relay League, held at Chicago on August 19th, 20th, and 21st, aroused great enthusiasm. Lectures were given by prominent American radio authorities, and the subjects dealt with covered a wide and useful range.

On August 19th Prof. W. J. Williams, of Rensselaer Polytechnic Institute, told of his experiences in the study of radio interference; while Mr. J. C. Warner, of the General Electric Co., dealt with recent advances in wireless valve research. He announced the completion of work tending towards a standardisation of valve bases and sockets.

Dr. A. Hoyt Taylor, Superintendent of the Naval Research Laboratory at Bellevue, D.C., dealt very com-

prehensively, on August 20th, with crystal controlled radio transmitters and short wave propagation phenomena. The interest of Dr. Taylor's lectures was considerably enhanced by the facts which he was able to adduce from work carried out at the Naval Laboratory.

Mr. John A. Miller, who addressed the Convention on August 21st, emphasised the importance of using lower power in radio transmission. He pleaded for the use of highly efficient transmitters designed to cover the most "miles per watt." To encourage efforts in this direction Mr. Miller announced that the Jewel Electrical Instrument Company offered a twenty-one jewel watch to the member of the A.R.R.L. who succeeded in covering the greatest distance on the "miles per watt" basis.

BROADCAST BREVITIES

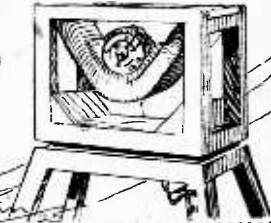
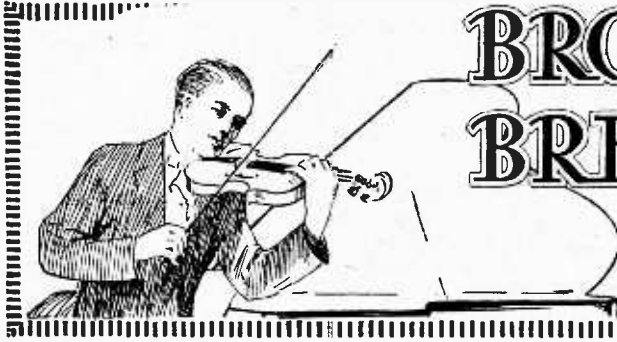

SAVOY HILL TOPICALITIES.

Overseas Programmes.

A good deal of publicity has been given to the super receiving station which is to be erected at Hayes, near Bromley, Kent. The idea appears to have gone abroad that a scheme for broadcasting full-sized programmes from America is on the eve of fulfilment. That is not the case.

o o o o

No Station Yet.

The international receiving station at Hayes does not at the moment exist, and when it does come into operation it will contain nothing exceptional or unique in the way of apparatus, save, perhaps, as regards the method of erecting the aerial, which will be only five feet in height.

o o o o

Broomstick Aerial.

When the original experiments were carried out in the same locality two years ago in a field used normally for sports, it was found convenient to erect a temporary aerial which could be put up rapidly and as quickly taken down. This aerial was supported by broomsticks, and consisted of one strand of wire only held in cleats on the broomsticks. It took twenty minutes to erect, and was removable in the same space of time.

o o o o

American Concerts.

On several occasions the reception of American concerts was remarkably successful, and it was decided that the permanent aerial should be of similar design and earthed at both ends.

o o o o

Temporary Aerials.

In addition to the permanent aerial, temporary aerials will be erected for directional reception. If, for instance, it is desired to receive Moscow, an aerial will be run out in the required direction to get the best results. Aerials of the Beveridge type will be largely employed.

o o o o

The Plant.

The Hayes apparatus will contain ten or a dozen H.F. valves and two or three L.F. stages, and will embody a corrector circuit. The latter was rather curiously mis-described in the daily Press as a

FUTURE FEATURES.

Sunday, September 6th.

LONDON.—3.30 p.m., Ballet Music and Songs. 9 p.m., Casano's Octet.

BIRMINGHAM.—9 p.m., Russian Composers.

CARDIFF.—9 p.m., Symphony Concert.

MANCHESTER.—8.50 p.m., Chamber Music.

GLASGOW.—9 p.m., Light Orchestral Programme.

Monday, September 7th.

LONDON.—9 p.m., "Radio Radiance."

Tuesday, September 8th.

5XX.—8 p.m., The Kneller Hall Band.

ALL STATIONS (except 5XX).—8.25 p.m., "The Duenna."

Wednesday, September 9th.

LONDON.—8 p.m., The Three Choirs Festival, relayed from the Shire Hall, Gloucester.

BIRMINGHAM.—9.30 p.m., Recital of Scots Songs by Carmen Hill.

BOURNEMOUTH.—8 p.m., An Evening at Weymouth.

CARDIFF.—8 p.m., "The Celtic Temperament."

BELFAST.—7.30 p.m., Symphony Concert.

Thursday, September 10th.

5XX.—9 p.m., "Radio Radiance."

LONDON.—8 p.m., Chamber Music.

ABERDEEN.—8 p.m., Brahms Programme.

GLASGOW.—8 p.m., Popular Portraits.

Friday, September 11th.

LONDON.—8 p.m., The Three Choirs Festival, relayed from the Shire Hall, Gloucester.

NEWCASTLE.—9.30 p.m., "The Good-humoured Ladies."

Saturday, September 12th.

LONDON.—8 p.m., Popular Orchestral Programme including John Henry.

BOURNEMOUTH.—8 p.m., "Tit-Bits."

device for correcting, amplifying, and purifying transmissions. Some curiosity was also shown as to the call-sign of the station. Obviously, broadcast cannot be purified at a receiving station, nor will Hayes, which is not intended to be a transmitting station, have a call-sign.

o o o o

Calibration Tests.

The calibration tests which took place during the last fortnight of August were important as representing a serious attempt to establish the principle that special care is necessary in preserving accuracy in broadcast wavelengths throughout the country. Standardised measurement of wavelengths employed in different countries has hitherto failed; sometimes, indeed, the divergence has been considerable. It is not only in the interest of listeners but in the interest of broadcasting as a whole that stations should adhere rigidly to their wavelengths, and the calibration tests which took place from Eiffel Tower on alternate nights for a period of a fortnight were, therefore, of the utmost value.

o o o o

The Procedure.

A special code of signals was employed, and exact wavelengths, obtained by standard measurements, were transmitted from Eiffel Tower at one-minute intervals on prearranged wavelengths. The signals and measurements were picked up in this country, and the engineers made comparisons to enable them to check the precise wavelengths on which B.B.C. stations were working.

o o o o

A Preliminary Canter.

The international standard of wavelength calibration was a prelude to the rehearsal of the new wavelengths which are being carried out on the dates announced in last week's issue of *The Wireless World*.

o o o o

Daventry Reception.

A number of listeners at Ipswich signed a petition recently expressing dissatisfaction with the results obtained from Daventry, and asking that steps should be taken to protect their interests as listeners. It is of interest to note that many good reports were received from

Ipswich, which shows that the dissatisfaction in that part of East Anglia was not general. The following selection is worth recording:—

- (1) Ten per cent. stronger than Chelmsford.
- (2) Comfortable on two 'phones.
- (3) Survey Department, G.P.O.; "Little (if any) below Chelmsford."
- (4) Quite as good as Chelmsford.
- (5) Very little short of Chelmsford. Quite distinct on indoor aerial.

Felixstowe and Bildeston are other places in the Eastern Counties from which it was reported that reception from the new 5XX was "never bettered by Chelmsford."

oooo

Crystal Users.

As regards crystal sets, the trouble appears to resolve itself into the following two points:—

- (1) The fact that there are a great number of inefficient crystal sets in use,

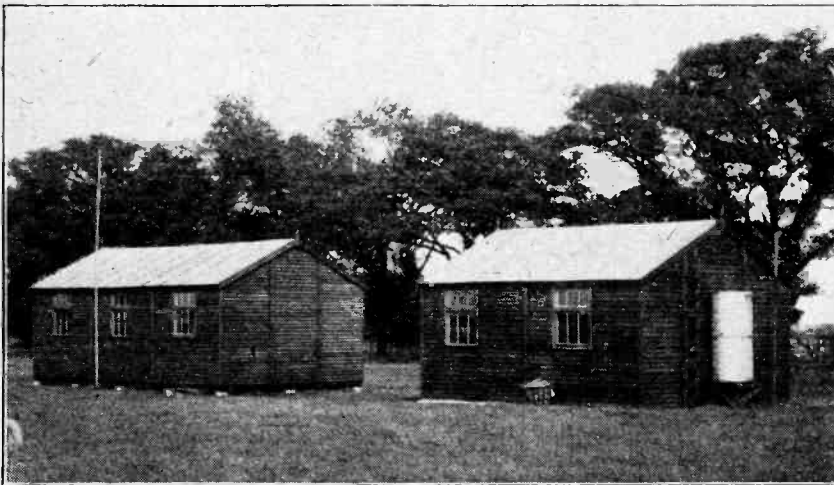

THE INTERNATIONAL RECEIVING STATION. There is nothing in the external appearance of the B.B.C.'s listening station at Hayes, near Bromley, to suggest the important part it is likely to play in British broadcasting. The aerial is to be only 5 feet in height.

as a result of listeners having hitherto had very strong signals from Chelmsford.

(2) Observing that the country reports have been on the whole satisfactory in the neighbourhood of Ipswich, while the town reports from Ipswich express dissatisfaction, there can be no doubt that the lack of room in the town results in inefficient aeriels. Ipswich is low-lying on a heavy soil, so that earths would not to any appreciable extent affect the matter.

oooo

Long-Distance Reports.

Crystal reception from 5XX has been reported in Belgium, Newquay, The Hague, and Edinburgh, and on an indoor aerial at Cardiff and South Shields. One letter has been received by the B.B.C. from America of reception on August 6th in Oklahoma.

oooo

Out in the Open.

Outdoor listening is not an unmixed blessing, and some annoyance has ap-

parently been caused in several suburban districts by the use of loud-speakers in gardens and at open windows. There is no law on the subject, but it is hardly likely that the annoyance would be so serious as to cause resort to the law to attempt to define the position. On the whole, broadcast listeners are as considerate as any body of enthusiasts, and it is probable that a direct appeal in any individual case would have the desired effect. At any rate, the cool nights will soon be with us, and this will be sufficient to take the warmth away from the most enthusiastic of users of loud-speakers in the open.

oooo

A Problem.

The broadcast of Mr. Bransby Williams on four evenings in one week brings up a problem which has caused the B.B.C. some anxiety on numerous occasions. In the first place, the wireless cannot at present offer a music-hall artist an engagement of the standard to which he is accus-

must await—and sometimes for a very long time—the opportunity of making arrangements for broadcasting such entertainers. And when a music-hall artist is out of a stage engagement for a week, the microphone must "catch" him as often as it can in that period. Hence the mild complaint of some "stars" of the music-hall that a good deal more is required of them by the wireless in a week than the music-hall demands of them in a month.

oooo

Broadcasting Hopes in Ceylon.

Wireless enthusiasts "exiled" in Ceylon will not for long be deprived of opportunities of listening to broadcasting, states an Indian correspondent. Certain experiments recently carried out go to show that the serious apprehension that Ceylon is hopelessly screened is without foundation. A four-valve receiver installed at Kandy has picked up transmissions from Colombo with perfect ease, and no difficulty whatever should be experienced in receiving broadcasting when the large station at Welikado is opened.

oooo

ATMOSPHERICS.

At the San Francisco Radio Exposition from August 22nd to 28th, radio entertainers met listeners "face to face." This cool heroism evoked widespread admiration.

oooo

The B.B.C. is blamed because the events dealt with in the news bulletins are too gloomy. It is understood that, for the benefit of listeners, steps are being taken to prevent the occurrence of any further train disasters, fires, strikes, motor accidents, wars, and rumours of wars.

oooo

With the same solicitude for the feelings of listeners a calm day was chosen for the recent broadcasting of the arrival of a cross-channel steamer.

oooo

From a Book Review in a wireless contemporary: "The wealth of analogies which he uses are always delightfully opposite."

The distinguished author is understood to be making favourable progress.

oooo

A French savant states that you should address the microphone as if you were speaking to a lady. The difficulty of maintaining the illusion is due to the unresponsive nature of the instrument.

oooo

"Listeners who have their earthing switches inside the house," says a Press writer, "may one day think better of it." On the other hand, they may not have time.

oooo

A mining engineer suggests the possibility of finding gold by wireless. No confirmation is available of the rumour that eager enquiries are being made by the Chancellor of the Exchequer.

oooo

A gold medal is offered for the best wireless "invention." A unique opportunity is thus presented to compilers of DX records.

tomed. In the second place, few artists, even of first-class merit, are prepared to undergo the strain of entertaining the same audience, night after night, with the consequent draining of their entertainment resources within a very brief space of time.

oooo

Radio "Stars."

By comparison with the average music-hall artist, it may be said, parenthetically, broadcast "stars" like John Henry, Vivian Foster, and others, are really shining lights; because whereas the music-hall artist can work off the same gag in a dozen different halls, the wireless artist has almost exhausted the humour in a particular joke when he has broadcast it once.

oooo

Music-hall "Stars."

The B.B.C., therefore, while anxious to secure the services of any artist whose name is familiar to music-hall audiences,

CRYSTAL DETECTORS.

The Electrical Properties of Contact Rectifiers.

By F. M. COLEBROOK, B.Sc., D.I.C., A.C.G.I.

THE subject is considered entirely from the electrical point of view, without any reference to the physical mechanism of the rectification process, and the greater part of the paper will be devoted to crystal detectors themselves, not associated with any form of receiving circuit. This is necessary in order to arrive at an understanding of the behaviour of the detector in the more complicated conditions involved in actual reception.

The structure of the paper is approximately as follows:—

- A. The crystal detector considered by itself.
 - 1. Continuous wave rectification.
 - (a) Fundamental principles.
 - (b) Direct current side.
 - (c) High-frequency side.
 - (d) Crystal as energy transformer.
 - 2. Rectification of modulated continuous waves.
 - (a) Direct current side, H.F. resistance.
 - (b) Modulation frequency side.
 - (c) Crystal as energy transformer.
- B. Crystal in association with receiving circuits.
 - 1. Direct reception.
 - 2. Crystal-valve combinations.
- C. Effect of various conditions of operation. General conclusions.

The writer has recently made a thorough investigation into the behaviour of crystal detectors in wireless telegraphy and telephony. The work was necessarily detailed, and involved the frequent use of mathematics, but a number of definite and practical conclusions were obtained. This article was written with a view to giving prominence to those results which have a practical significance.

The Fundamental Principles of Continuous Wave Rectification by a Crystal Detector

Any conductor which, under the action of an alternating electromotive force, will permit a greater quantity of electricity to pass in one direction than in the other can be described as a rectifying conductor, since the difference between the forward and the reverse direction quantities of electricity will be equivalent to a small continuous current in one direction. A crystal detector is a conductor of this kind. For instance, a piece of galena and a perikon detector will have current-voltage characteristics similar to those shown in Fig. 1.

An inspection of this diagram is enough to show that such a detector will behave very differently with respect to large and small signal amplitudes. For small signals,

For larger signals, say, over 0.5 volt in amplitude, the characteristic can be represented very approximately as in

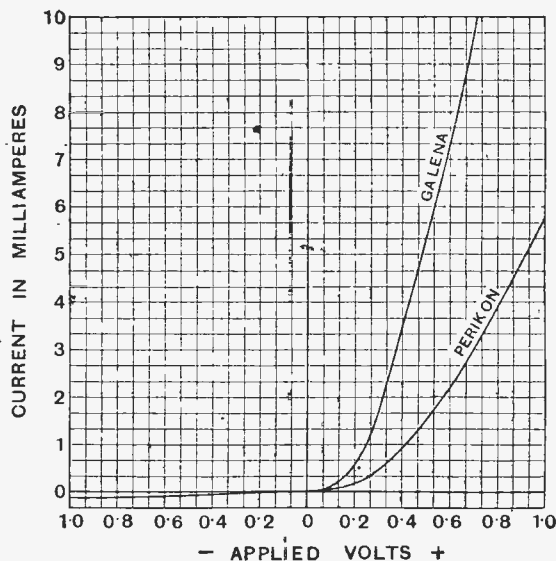

Fig. 1.—The characteristics of two typical rectifying crystals.

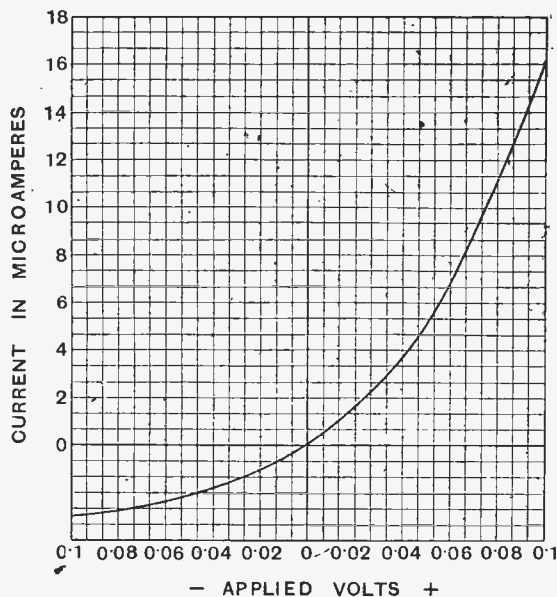

Fig. 2.—A characteristic for inputs up to 0.1 volt.

i.e., up to about 0.1 volt in amplitude, a suitable enlargement of the relevant part of the characteristic will give a curve like that in Fig. 2. For such a curve the current can be expressed very approximately in terms of powers of the voltage up to the fourth. This is useful from a theoretical point of view, since it permits of the calculation of the behaviour of the detector under any specified conditions.

For larger signals, say, over 0.5 volt in amplitude, the characteristic can be represented very approximately as in

Crystal Detectors.—

Fig. 3. This condition can also be treated mathematically. It is clear that rectification will be much more complete in the latter case than in the former, a conclusion which is in agreement with the well-known fact that crystal reception is much more effective for strong than for weak signals.

The writer has not been able to find any simple representation for the whole course of the characteristic, but has confirmed experimentally that the above limiting conditions represent very closely the actual behaviour of a crystal detector of either of the two more common kinds, *i.e.*, galena and zincite-bornite, or any detector having a sharply curved characteristic of the kind shown in Fig. 1.

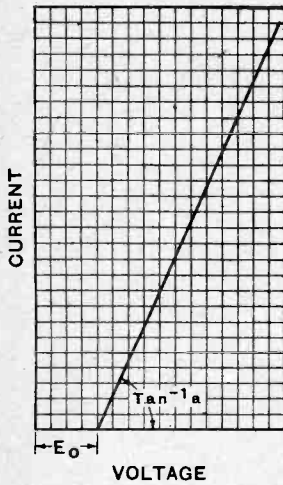

Fig. 3.—The approximate characteristic for large inputs—over 0.5 volt.

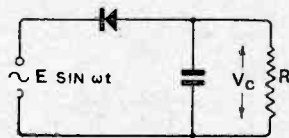

Fig. 4.—A circuit with a crystal rectifier, load R and bypass condenser.

In all that follows the terms large and small signals will be taken to mean values of the order indicated above.

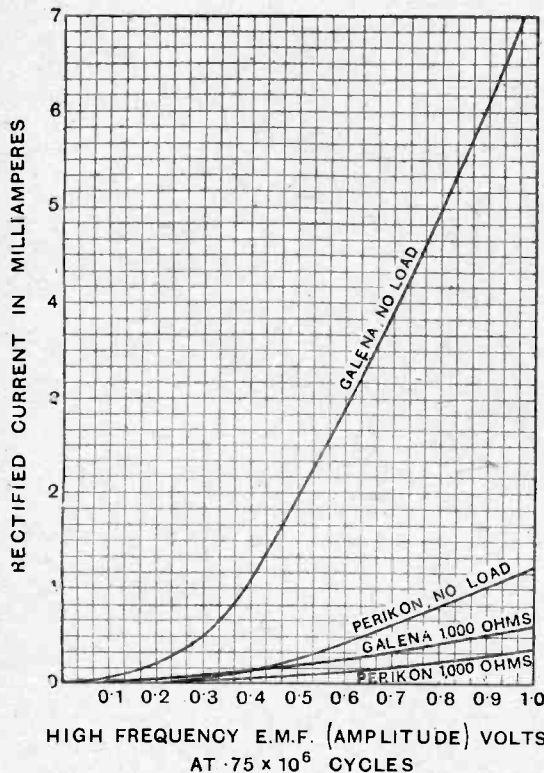

Fig. 5.—Rectification characteristics for perikon and galena on no load, and with a load of 1,000 ohms.

B 2f

In the discussion of the operation of a crystal detector by itself it will be assumed that the alternating e.m.f. operating is a maintained e.m.f., *i.e.*, one which is independent of the load imposed on it by the detector. This is certainly not the case in the direct crystal reception of wireless signals, but it is the easiest way of determining the properties of the detector alone.

Continuous Wave Rectification. The Direct Current Side of the Process.

The circuit to be considered is shown in Fig. 4, which represents a crystal detector in series with a source of high-frequency alternating electromotive force, and with a pure resistance load of magnitude R , the load being short-circuited by a condenser which is large enough to provide a path of negligible impedance for any high-frequency components of current flowing in the circuit.

As explained above, a small direct current will flow in the circuit as the result of the rectification of the alternating e.m.f. This current will be represented by i_c . Since there is this current flowing in the circuit, there must be somewhere in the circuit an effective direct

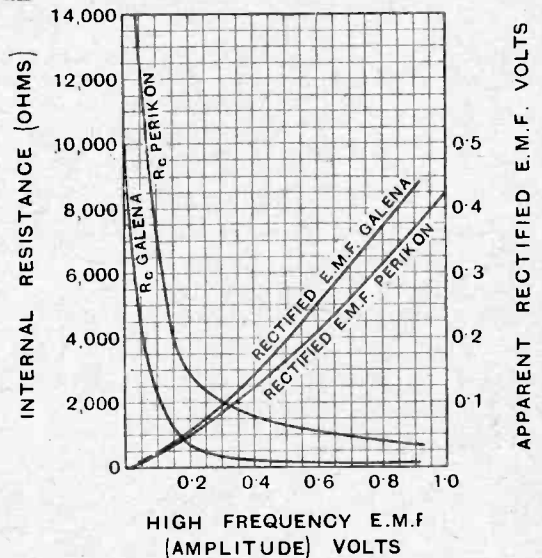

Fig. 6.—Values of internal resistance and apparent rectified e.m.f. for galena and perikon at no loads.

e.m.f. which we will call E_c . Moreover, if the load resistance R is reduced to zero the current i_c will not rise to an exceedingly large value, so that there must be some other resistance somewhere in the circuit which limits the magnitude of the no-load current. If we call this resistance R_c we have by Ohm's law the simple relation :

$$i_c = \frac{E_c}{R + R_c}$$

These two quantities R_c and E_c must obviously be associated with the crystal itself, and we can call them the rectified e.m.f. and the effective internal resistance. Here, then, are two important quantities which will play a large part in the rectification performance of the detector, and the first thing to do is to find out, experimentally or otherwise, something about their magnitude and their variation.

Crystal Detectors.—

Of the two it seems probable that E_c will be the more important in practice. This is illustrated by the curves of Fig. 5, which were obtained experimentally. These curves show the variation of i_c with the magnitude of the alternating e.m.f. for a galena and a perikon detector with $R=0$ and $R=1,000$ ohms. From the no-load curves it would appear that the galena detector is about six times as sensitive as the perikon (or zincite-bornite), but a load of 1,000 ohms reduces this apparent superiority to less than twice. This indicates that as between these two detectors the chief difference is that R_c is much lower



Fig. 7.—Connections of apparatus with which the values of E_c on open circuit for various signal voltages were measured.

for galena than for perikon. With a comparatively high resistance load in series the effect of the lower value of R_c is greatly reduced.

For any given crystal both E_c and R_c depend on the signal amplitude and to a less extent on R . By analysis and by experiment it can be shown that E_c will increase with the signal amplitude and with R , while R_c decreases with the signal amplitude and with R . The limiting values of these quantities when $R=0$ can be measured,¹ also the limiting values of E_c when R is made infinite, i.e., on open circuit. This latter is a very interesting case which will be described more fully later on.

Internal Resistance and Apparent Rectified E.M.F.

The curves of Fig. 6 will give some idea of the values of E_c and R_c for galena and perikon at no load. Of course individual specimens of these two detectors will show very considerable variation among themselves, and

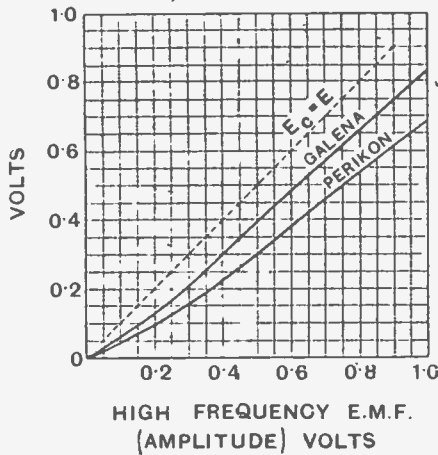

Fig. 8.—Showing E_c for various values of input volts.

for any given specimen the position and pressure of the contact may also cause appreciable variation, but the curves shown can be taken as fairly representative of these two types of crystal, with a possible variation of 50 per cent. or so for different specimens. In general it can be said that for moderately large signal amplitudes

E_c will probably be about a half of the signal amplitude at no load, the no load value of R_c being of the order of 100 ohms for galena and anything from 500 to 1,000 ohms for perikon. In both cases there will be a rapid increase in the magnitude of R_c as the signal amplitude decreases from about 0.3 volt.

It has been said above that for any given value of the signal amplitude E_c will increase with R . In fact it reaches a maximum value when R is made infinite. With

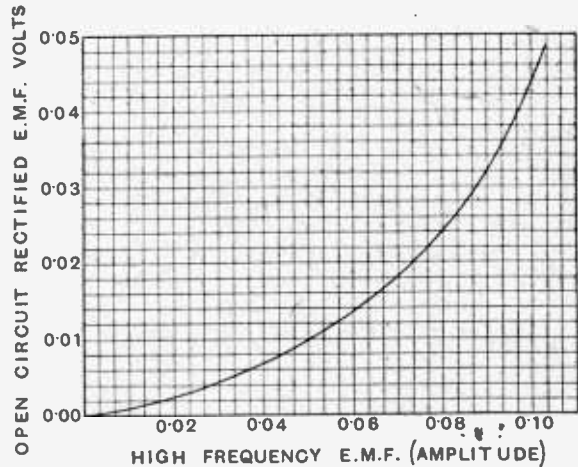

Fig. 9.—Open circuit rectified e.m.f. for galena detector.

an infinite load the current i_c is of course zero, but the back e.m.f. across the load is not zero. In fact, putting v_c for this back e.m.f., i.e., for Ri_c , we have

$$v_c = Ri_c = \frac{R}{R + R_c} E_c,$$

and when R is made infinite (the circuit being as illustrated in Fig. 7),

$$v_c = E_c.$$

The values of E_c on open circuit corresponding to various signal amplitudes were actually measured by the writer by connecting what was essentially a sort of Moullin voltmeter across the terminals of the condenser shown in Fig. 7. The results for a typical pair of detectors are shown in the curves of Fig. 8. The most striking feature of these curves is the relatively large value of E_c/E , E being the signal amplitude.

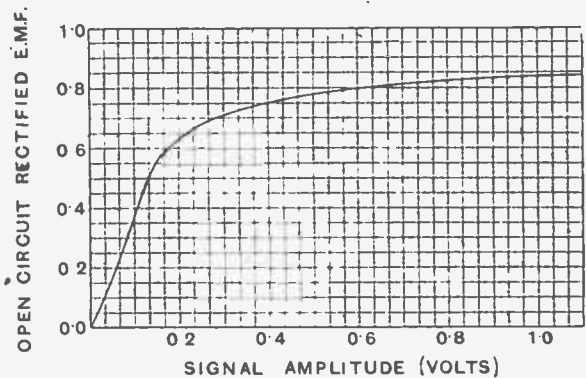

Fig. 10.—Ratio of open circuit rectified e.m.f. to signal amplitude for galena detector.

¹ See *Experimental Wireless*, March, April and May, 1925.

Crystal Detectors.—

For a characteristic of the type shown in Fig. 3 it is easy to show mathematically that

$$E_c = E - e_o.$$

Using this type of characteristic to represent approximately the actual characteristic of the crystal detectors considered, then for galena e_o will generally be about 0.1 to 0.2, while for perikon it will vary from 0.3 to 0.4. For signal amplitudes greater than about 0.5 volt the measured performances are seen to be fairly consistent with this simple straight line representation, particularly in the case of galena, the static characteristic of which is a much closer approximation to the simple straight line form than that of perikon.

The open-circuit rectified e.m.f.'s for very small signal amplitudes are not easy to measure experimentally, but they can be calculated for any given form of characteristic. The curve of Fig. 9 refers to a fourth power curve which can be considered as representative of a galena detector working at small signal amplitudes. It

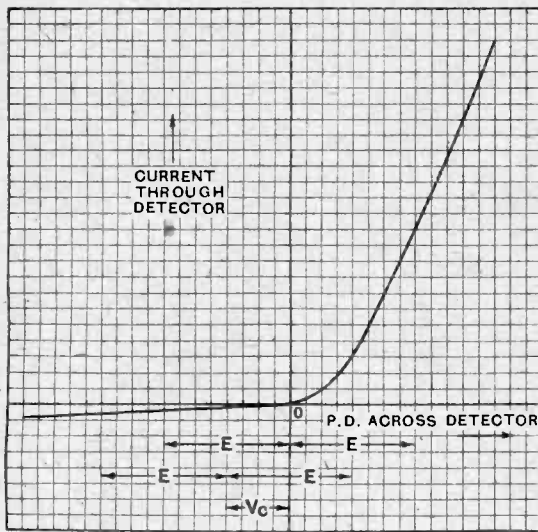

Fig. 11.—Current-voltage characteristic of a detector.

will be seen that the ratio of E_c (open circuit) to E decreases rapidly as E decreases. The variation of this ratio with E is of the character illustrated in the curve of Fig. 10.

Effect of a D.C. Load.

Before leaving this part of the subject, it will be well to illustrate the effect of a d.c. load on the rectification process by reference to the actual current voltage characteristic of the detector, since some very important deductions can be made in this way. Referring to Fig. 11, the process of rectification with no d.c. load can be represented as the result of a simple harmonic alternation of electromotive force about the origin of co-ordinates as centre. The current in the circuit will be an alternating one having a wave form something like that illustrated in Fig. 12. The continuous current will be the mean value of this alternating current over a period, and the fundamental high-frequency current will be the fundamental component of this wave form. If, now, a d.c.

load, short-circuited by a condenser, is put in series with the detector, then the continuous current in the circuit will give rise to a continuous back e.m.f. of magnitude v_c , say, the effect of which will be, so to speak, to shift back the centre of the oscillation of electro-motive force (without altering its amplitude) by the amount v_c as

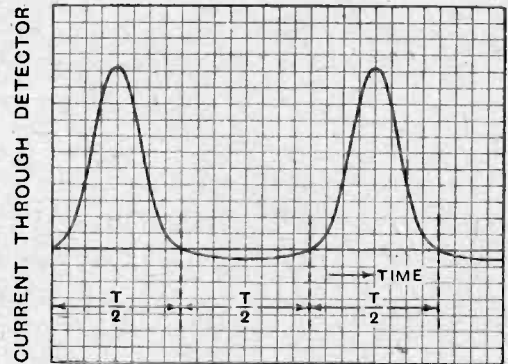

Fig. 12.—Current through detector with no load.

shown in Fig. 11. The wave form of the current will now be something like that shown in Fig. 13.

It is clear that this shifting back of the centre of the oscillation will modify every feature of the rectification process. Not only is the continuous component of the current decreased, but the fundamental component of the wave form is also reduced. In other words, the d.c. load increases the high-frequency resistance of the detector, even though none of the high-frequency current flows through the load. The high-frequency power consumed by the detector thus depends on the output or d.c. load, just as the input or primary circuit resistance of an alternating current transformer depends on the load imposed on the secondary circuit. In fact, a crystal detector can be regarded as an energy transformer of a special kind, one which transforms high-frequency power into continuous current power, the amount of the high-frequency

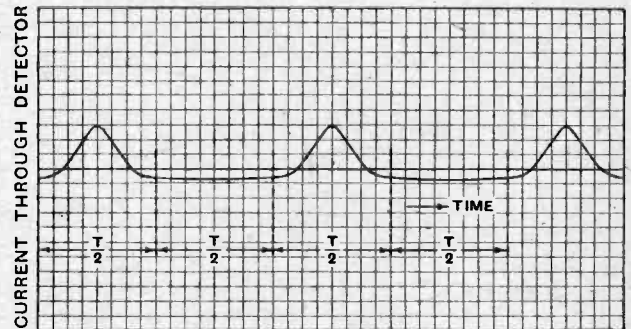

Fig. 13.—Wave form of current through detector with a resistance load.

power consumed depending to a large extent on the amount of continuous current power taken out of it. This is the most important feature of a crystal detector, and will be considered more fully in later sections of the paper.

(To be continued.)



A Review of the Latest Products of the Manufacturers.

THE ETHOPHONE TWO-RANGE WAVEMETER.

EVER since the inception of broadcasting the need has been felt for a direct reading wavemeter which should be simple in operation and yet sufficiently accurate to enable the various stations to be identified.

The problem of manufacturing instruments which will not require individual calibration has been solved in the case of the Ethophone wavemeter by assembling from component parts made with the utmost precision and each tested to be within narrow limits of accuracy to the required values. By this means individual calibration is avoided and it becomes possible to fit each instrument with a pre-calibrated etched wavelength scale.

The instrument is of the simple buzzer type and is provided with a changeover

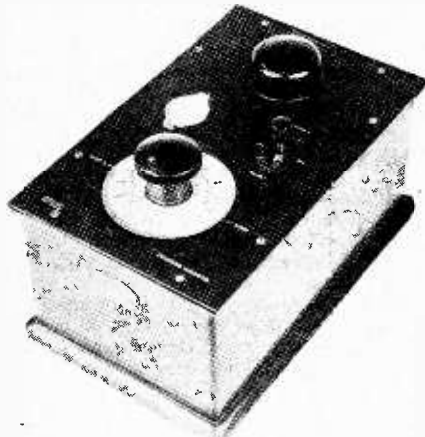

Ethophone two-range buzzer wavemeter, a recent product of Messrs. Burndept Wireless, Ltd.

switch so that it can be used on the 1,600 metre wavelength as well as the entire band of wavelengths used by the British broadcasting stations.

The components forming the tuned circuit are robustly constructed and rigidly set up so that the calibration can be relied upon to remain constant. An easily accessible dry battery is included in the instrument to operate the buzzer, the latter being of unique design, producing a high-pitched note without trouble by sticking contacts.

On test and compared with a reliable standard, calibration was found to be accurate within very narrow limits over the entire range and it was possible to identify distant broadcasting stations by wavelength alone.

REFLEX COILS.

Unmounted inductance coils are obtainable from The Reflex Radio Co., 45, Stamford Hill, London, N.16. Apart from their use for ordinary tuning purposes an unmounted coil of reasonably low self-capacity is often required as a radio frequency choke, and the Reflex coils can be relied upon as suitable for this purpose, being wound by the well-known Burndept process.

"BELLING-LEE" SUB-CONNECTORS.

These connectors, which are made by Messrs. Belling & Lee, Ltd., Queensway Works, Ponders End, Middlesex, have been put on the market with the object of relieving the home constructor from the necessity of soldering the connections in his receiver.

As will be seen from the illustration the system lends itself particularly to the use of square connecting wire. One or more wires may be inserted in the slotted terminal post and held in position with

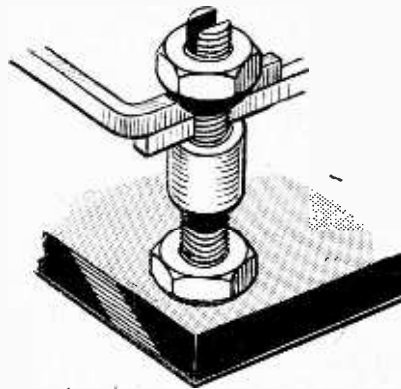

Terminal spindle with sub-connector.

a shallow nut. The connectors are supplied with No. 2, 4, 5 and 6 B.A. threads, and "floating connectors" for making junctions which do not require to be secured to the receiver panel are

also available. The system should prove very effective, provided that all the joints in the receiver are accessible.

RAVALD VARIABLE CONDENSER.

An unusual form of construction is adopted in the variable condenser manufactured by Messrs. J. Moores & Co., Raval Street Works, Salford, Manchester.

A sheet of copper measuring about 2in. by 2in. is held down on the face of a piece of ebonite by means of a piece of mica and three small bolts, one serving as a terminal. Over the mica is the other plate of the condenser which is arranged to normally spring away from the face of the mica. By means of a threaded bush and screw which carries the operating knob and dial the distance between the two copper plates can be critically regulated, thus controlling the capacity presented between

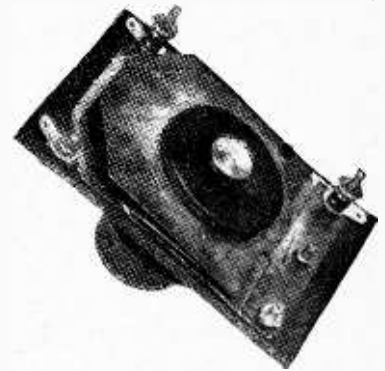

Underside view of variable condenser with mixed air and mica dielectric.

them. One revolution of the dial, which is calibrated into one hundred divisions, produces ample capacity change for tuning circuits adjusted to broadcasting wavelengths, though in revolving the knob to produce an increase of capacity the dial will be found to lift from the face of the instrument panel.

A particular merit of this component is that it occupies very little depth behind the instrument panel, whilst the area taken up is not greater than that of a condenser with rotating plates. Another feature is that a positive connection is made with the plates and the rubbing contact met with when employing revolving plates is avoided.

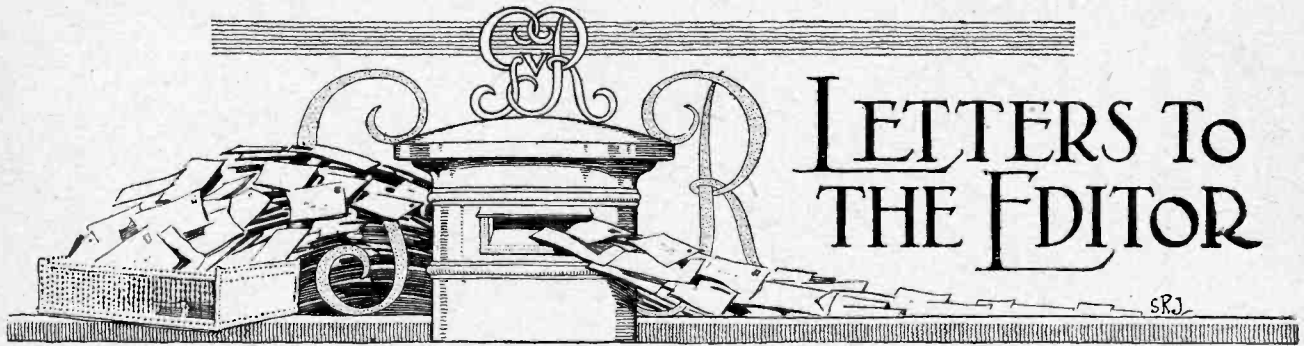

The Editor does not hold himself responsible for the opinions of his correspondents.

Correspondence should be addressed to the Editor, "The Wireless World," 139-140, Fleet Street, E.C.4, and must be accompanied by the writer's name and address.

RESULTS WITH A O-c-1.

Sir,—I enclose a circuit diagram of a crystal and L.F. circuit which I have been experimenting with, and with which I have had excellent results.

The novel feature is, of course, a reaction coil, " L_2 ," which boosts up signals very well indeed.

The circuit may, of course, be already known to you and other experimenters, but, again, perhaps it may interest some of the "one-valve merchants" who, like myself, are unable to afford multi-valve sets.

The four-pole, double-throw switch (I use a "Utility") cuts out the amplifier and leaves just a plain condenser-tuned crystal circuit.

No variable resistance is used, and a fixed "Igranic" resistance is used in conjunction with the third pair of points on the switch for lighting the valve. Amplifying valves of the .06 type give excellent results with this circuit, and are economical in filament current. Condenser C_1 has a capacity of 0.0005 mfd.,

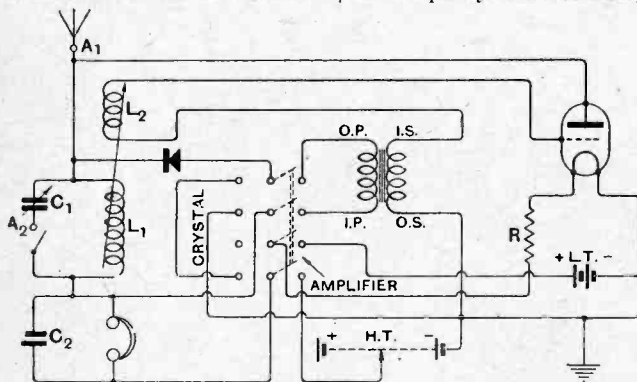

The circuit used by Mr. J. R. W. Dunbabin.

and C_2 , 0.001 or 0.002 mfd. For the 300-500 metre wave-band L_1 should contain 50 turns on a $3\frac{1}{2}$ in. former, and L_2 , 70 turns if mounted to rotate inside L_1 .

The following stations have been received on a moderate aerial: 2JO, 5IT, 6BM, 2ZY, 5NG, 6ST; School of Posts and Telegraphs, Paris; Radio Iberica, Radio Paris, and last, but not least, 5XX at a distance of 20 miles, at full loud-speaker strength.

Several other stations have been heard, but I have been unable to distinguish their call-signs.

The set is very stable in operation if used with a crystal detector of the permanent type.

Trusting I have not taken up too much of your valuable time, and congratulating you on your splendid paper.

Newport Pagnell, Bucks. JOHN R. W. DUNBABIN.

REACTION AND INTERFERENCE.

Sir,—I read with interest the article "Reaction and Interference" in a recent issue. A few weeks ago I examined

a certain make of 4-valve receiver, and duly noted that a common H.T. of 120 volts was feeding all 4 valves, and it struck me that if this sort of condition prevailed in many districts there was little wonder the chief engineer of the B.B.C. uttered such heartrending pleading to the "howlers."

However, I kept the matter in mind, and on a recent Sunday morning, when I was listening to a special series of tests transmitted by my friend 5JC, Cemaes Bay, Anglesea, with 6YQ, throughout the test I could hear a very faint carrier wave immediately 5JC changed over, and I came to the conclusion that this must be the carrier wave of 6YQ's receiver. When the test concluded, and 5JC switched off, I at once changed over the amplifier voltage to feed the detector valve and called up 6YQ in order to find out whether the carrier wave which was heard was actually the "howl" from his receiver, and much to my astonishment he replied immediately, and reported my signals R4 with three valves. I then explained to him that I was "transmitting" with my receiver, and this he would not credit, and replied "Tks for dope."

Now, if an ordinary receiver in an oscillating condition could be reported R4 at 60 miles, then one can fully expect that the signal would be audible over a radius of 100 miles, and, of course, keeping in mind that the receiver similar to that mentioned in first paragraph was used, and with the voltage mentioned.

Details of my receiver are as follow: Aerial circuit, S.C. .003 mfd. Igranic coil No. 25 with .0005 mfd. condenser in parallel. Reaction coil, Igranic No. 35, not tightly coupled. Valves, AR 06 and DE 5, both used with equal success. H.T., 120 volts on detector valve. The usual grid condenser and leak values .0003 mfd. and 2 megohm. The aerial, twin inverted L type 35ft. high at open end and 28ft. at lead-in end. The wavelength used was 195 metres.

It will be observed that this impromptu test is a very interesting proof of what interference can be caused with an oscillating receiver, and possibly you may recollect the report which was published in your journal of the test carried out by 5DC St. Annes-on-Sea, using 25 volts on the plate of a T 15 valve, the transmission being intercepted here perfectly.

The Post Office, and also the B.B.C. may like to know of this, as no doubt it will strengthen their case on the "howling" nuisance.

TRANSMITTER.

FREE LICENCES FOR THE BLIND.

Sir,—I believe that I am correct in stating that it is not usual for dog licences to be taken out by those afflicted with blindness. A special concession is quite rightly made on their behalf.

Would it not be a very gracious act on the part of the authorities were they to permit wireless sets to be used free of licence by those who have not the blessing of sight?

It is not necessary for me to enlarge on the vital importance of wireless to the blind.

London, S.W.1.

A. M. LOW.
Hon. Tech. Adviser and Sec.
The Wireless League.



Readers Problems

Readers Desiring to Consult "The Wireless World" Information Dept., should make use of the Coupon to be found in the Advertisement Pages.

An Efficient Four-valve Set.

A READER has asked what, in our opinion, is the best number of valves and circuit to employ in a receiver designed to be as flexible as possible from the point of view of wavelength range and to receive several of the B.B.C. stations on the loud-speaker, using a reasonably efficient aerial and earth system.

Taking all things into consideration, undoubtedly the best all-round circuit which the amateur can construct is a four-valve receiver embodying one stage of H.F. and two of L.F., reaction being taken from the plate current of the detector valve to the aerial coil. If readers carefully follow out the circuit given in Fig. 1, taking care to use good quality components only and to space very carefully these components, paying particular attention to the wiring of the H.F. and detector valves, they will be in possession of a set which will give all that it is normally possible to receive from British and Continental stations. If at any time reception conditions are so bad that an efficient set of this type fails to give satisfaction, it is highly probable that a more sensitive instrument will give no greater satisfaction from the point of view of enjoying the programmes, since the extra sensitivity provided to bring in elusive distant stations will bring in also a great amount of atmospheric noises, and

thus the more sensitive receiver will defeat its own object. In order to obtain maximum efficiency it is advisable to wire up with bare wire, using short direct connections.

In order to obtain wavelength flexibility plug-in coils may be used, and here again much scope is given to the enterprising amateur in making his own coils, which, by being made efficient at the expense of rigidity, may often yield results superior to those obtainable from the commercial articles.

In the case of all amplifying valves it is advisable that the rheostat be placed in the positive filament lead, since in this position its adjustment will have no effect on the steady potential of the grid which should be adjusted independently by means of biasing cells. In the case of the detector valve, however, it is advisable to place the rheostat in the negative lead if the grid return lead is connected to +L.T. By this means a positive bias in excess of that required for rectification will be avoided. It will be noticed that separate terminals are given for the connection of a grid battery and an extra H.T. battery to the L.F. valves. The reason for this is that the amateur often desires to commence operations with a newly constructed set by dispensing with high quality reproduction. Consequently these two pairs of terminals can be respectively short-circuited and a single 60-

volt battery connected to the terminals supplying H.T. to all valves. Later two power valves can be used in the L.F. stages and an extra H.T. battery, and also a grid battery connected to the appropriate terminals.

Another feature is the inclusion of a large fixed condenser across the grid battery. Many cases of instability and distortion can be traced to the resistance of the grid battery acting as a coupling between valves, and the provision of this condenser, by offering a low impedance to the audio-frequency impulses, tends to alleviate this trouble in a manner similar to the case of the H.T. battery.

o o o o

Safeguarding Dull Emitters.

MANY readers living in districts far removed from any accumulator charging station are in the position of having to exercise rigid economy in their consumption of L.T., and as a rule they make use of a single-valve regenerative set for their purpose, employing a separate amplifier using power valves in conjunction with an accumulator at such times as they desire to operate a loud-speaker. Usually, of course, a 0.06 amp. type of dull emitter is used in the receiving set, operated from dry cells, and, provided that great care is taken not to reduce the efficiency of the valve by an excess of filament current, excellent results, fully equal to those obtainable with a bright emitter type of valve, are assured on distant stations. Unfortunately, however, the requisite filament voltage of these valves is such that it is extremely difficult to obtain the maximum efficiency from them without risk of partially ruining their dull-emitting properties. Two dry cells cannot satisfactorily be used to supply the necessary 3 volts, since it is found that the voltage of dry cells rapidly falls off, unlike the case of the accumulator, which maintains a fairly steady E.M.F. during the greater part of its charge.

Consequently, these dry cells and a 30-ohm rheostat are normally employed, fairly frequent adjustment of the rheostat being necessary as the battery voltage falls. Provided that it is possible to exercise careful judgment, excellent results are obtainable in this way, but there is no positive indication of when the filament is being operated within safe limits, many readers failing to obtain maximum efficiency by being over-cautious, whilst others quickly impair the

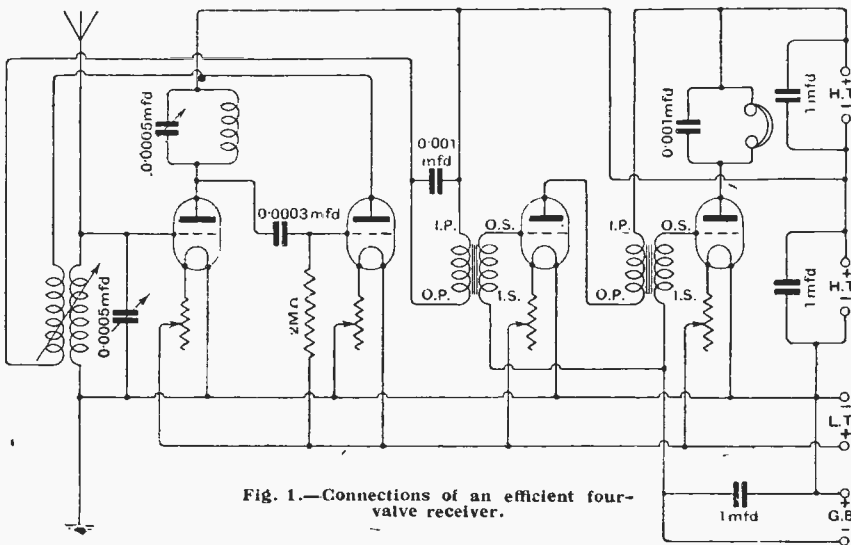

Fig. 1.—Connections of an efficient four-valve receiver.

efficiency of their valves by incorrectly adjusting the rheostat. Many readers favour the employment of a fixed resistance in series with the valve filament, so that no greater current than 60 milliamperes can pass through the filament when a given voltage is applied to the L.T. terminals. This idea is quite sound in the case of a four-volt accumulator whose voltage is more or less constant, but if used in the case of three dry cells the same disadvantage is present as in the case of two dry cells with no resistance.

An excellent method of overcoming this difficulty is to include a reliable small-scale ammeter in series with the L.T. battery, since in this case the filament current can at all times be accurately adjusted by means of the rheostat in accordance with the fall in the voltage of the dry cells, there then being no risk of ruining the valve, and at the same time the user is assured of maximum efficiency, since all guesswork is eliminated. Of course, it is imperative that a small-scale instrument be used with a maximum of reading about 0.1 amp.

Even if a four-volt accumulator is used this method is preferable to the use of a fixed resistance, since the filament adjustment of the detector valve is often critical for the best results on long-distance stations if the grid condenser and leak are neither capable of adjustment, whilst if one or two stages of L.F. are to be incorporated in the receiver three ammeters are not necessary, since fixed resistances may be used in conjunction with the L.F. valves, whose filament temperature does not, of course, require critical adjustment. In this case the ammeter should be connected so that it is in the filament circuit of the detector valve only.

o o o o

Efficient Design of Multi-valve Receivers.

A READER proposes to build a five-valve receiver in which for the sake of economy in current consumption the valves will all be of the sixty milliamperes class of dull emitter, and he wishes to know the best method

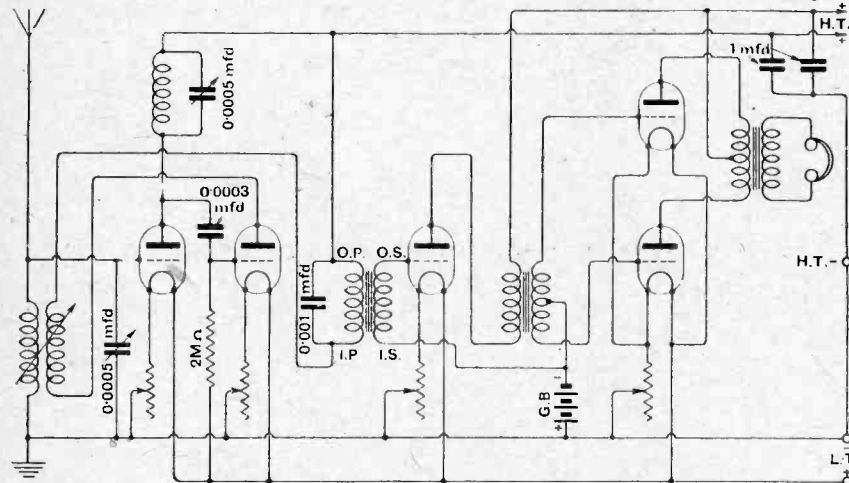

Fig. 2.—An efficient arrangement of five valves for good quality loud-speaker reception of distant stations.

BOOKS FOR WIRELESS BEGINNERS

Issued in conjunction with "The Wireless World."

"YOUR FIRST STEPS IN WIRELESS," by HUGH S. POCOCK. Price 9d. net. By Post, 11d.

"WIRELESS TELEPHONY," by R. D. BANGAY. Price 2/6 net. By Post, 2/9.

"THE WIRELESS TELEPHONE," by P. R. COURSEY, B.Sc. Price 2/6 net. By Post, 2/9.

"CAPT. ECKERSLEY EXPLAINS," by CAPT. P. P. ECKERSLEY. Price 2/- net. By Post, 2/2.

"UNCLE JACK FROST'S WIRELESS YARNS ON GOOD RECEPTION AND HOW TO GET IT," by CAPT. C. C. J. FROST. Price 2/- net. By Post, 2/2.

"DICTIONARY OF TECHNICAL TERMS USED IN WIRELESS TELEGRAPHY," by HAROLD WARD. Price 2/6 net. By Post, 2/8.

Obtainable by post (remittance with order) from
ILIFFE & SONS LIMITED,
 Dorset House, Tudor St., London, E.C.4,
 or of Booksellers and Bookstalls.

of employing these valves in order to fulfil the three conditions of reception of distant stations, stability, ease of manipulation, and good quality loud-speaker operation, it being specially mentioned that resistance coupling is to be avoided on the L.F. side of the amplifier on account of the high H.T. value which would be required.

To ensure reception over long distances it is recommended that one of the valves be employed as a high-frequency amplifier. The reason for the non-inclusion of two H.F. valves may very well arise in our reader's mind, since five valves are available. The reason is that when two H.F. stages are employed on receivers other than those of the neutrodyne type, it cannot be truthfully said that the instrument fulfils the condition of stability and ease of manipulation, whilst on the other hand, provided that it is efficiently designed, a receiver employing one stage of H.F. is quite sufficient for reliable reception of most of the B.B.C. and Continental broadcasting stations. Assigning

one valve for the usual purpose of rectification we have three valves which may be devoted to the low frequency portion of the circuit. Since resistance coupling is inhibited the suggestion of using three stages of choke-coupled amplification naturally occurs to the mind, but it must be remembered that no matter how much attention we may pay to the elimination of frequency distortion in this manner, we cannot assure good quality with a valve of this type operating in the final stage owing to the comparatively small useful grid voltage swing permissible. This difficulty can, however, be quite successfully surmounted by employing two valves in the final stage connected so that the input voltage swing is divided between the two valves. The first L.F. valve is, of course, connected as an ordinary transformer amplifier. By using good quality components and employing the last two valves in a push-pull amplifier in the manner suggested in Fig. 2, it will be found that good quality is obtainable on the loud-speaker without resorting to the use of special power valves.

o o o o

Improving Crystal Reception.

A READER living outside the 100 miles radius from the new high-powered station at Daventry finds that he is able to obtain reception on his crystal set quite clearly and free from interference, but that the strength obtainable is not sufficient for comfortable reception, and he asks whether there is anything which he could add to the receiver to improve results without resorting to the use of valves.

Since our reader states that the reception which he now obtains is quite clear and distinct, it is certainly possible to bring the signals up to good audibility sufficient for the operation of several pairs of telephones by employing some form of microphone amplifier. Of course, in the first place the utmost attention should be given to minimising losses in the aerial system and in the tuning circuits of the receiver. Many readers will find that by doing this, and at the same time employing a pair of adjustable reed type telephones wound to a high resistance, they are able to increase their signal strength very greatly so that weak signals are brought to comfortable audibility.

With others, however, this may not be sufficient and amplifiers of the type suggested may have to be employed. These instruments are very economical in use and will operate from four dry cells for many months without attention. The dimensions of the whole instrument together with enclosed batteries need not exceed the dimensions of an average type crystal set. It is strongly recommended, however, that a well-made type of manufactured instrument be employed; crystal users who attempt to economise by making their own amplifier are apt to be disappointed. Trouble is almost certain to be experienced through "packing" of the carbon granules in the microphone unless it has been specially designed for the purpose.

The Wireless AND RADIO REVIEW World

No. 317.

WEDNESDAY, SEPTEMBER 9TH, 1925.

VOL. XVII. NO. II.

Assistant Editor:
F. H. HAYNES.

Editor:
HUGH S. POCOCK.

Assistant Editor:
W. JAMES.

Editorial Offices: 139-40, FLEET STREET, LONDON, E.C.4

Telephone: City 4011 (3 lines).

Advertising and Publishing Offices: DORSET HOUSE, TUDOR STREET, LONDON, E.C.4.

Telephone: City 2847 (13 lines).

Telegrams: "Ethaworld, Fleet, London."

COVENTRY: Hertford Street.

BIRMINGHAM: Guildhall Buildings, Navigation Street.

MANCHESTER: 199, Deansgate.

Telegrams: "Cyclist Coventry."
Telephone: 10 Coventry.

Telegrams: "Autopress, Birmingham."
Telephone: 2970 and 2971 Midland.

Telegrams: "Hiffe, Manchester."
Telephone: 8970 and 8971 City.

Subscription Rates: Home, £1 1s. 8d.; Canada, £1 1s. 8d.; other countries abroad, £1 3s. 10d. per annum.

As many of the circuits and apparatus described in these pages are covered by patents, readers are advised, before making use of them, to satisfy themselves that they would not be infringing patents.

THE PURPOSE OF EXHIBITIONS.

ALMOST every industry in this country which makes a popular appeal can boast at least one annual Exhibition or Show. The annual exhibition should constitute a milestone in the history, not only of an industry as a whole, but of every individual manufacturer who constitutes a unit of the industry. The outstanding feature of an annual show should be a record of progress, and no industry can be regarded as healthy unless the annual show does bring to light a multitude of new things, each tending to mark in some direction or another a distinct step forward in development.

An industry so new as that which has arisen through broadcasting should be particularly progressive, for so much scope exists for invention and initiative. Improvements follow one another so quickly that it is likely to be some years before a state of development will have been reached when it will be possible to consider that any degree of perfection has been achieved.

As time goes on we find that each annual wireless exhibition tends to mark more and more distinctly the stages in progress. It is the occasion for the introduction by manufacturers of new models of broadcast apparatus, and in most cases these models remain current during the ensuing twelve months, during which time ingenuity is being exercised in the endeavour to produce replacements for these models with others embodying technical developments for the following year's show.

The present issue of *The Wireless World* constitutes a comprehensive guide to what may be seen at the Albert Hall Exhibition this year, and so much that is new will be displayed for the first time that it may be expected that the Exhibition will be more popular than any of its predecessors. Looking back over past years in

the short history of broadcasting, one cannot help remarking upon the definite changes in fashions in wireless which have been brought about. Apparatus which a year or two ago was the very latest development, to-day looks sadly antiquated alongside the new products. The reasons for these changes in the character of apparatus are not difficult to trace. The public is becoming continually more critical of the work of the manufacturer, and, whereas a year or two ago a ready sale could be anticipated for almost any apparatus which worked, to-day the public is in a position to differentiate very definitely between the various grades and types of instruments. The large increase in the number of broadcasting stations and the interest taken in short-wave transmissions from abroad have resulted in a public demand for sets capable of long-distance reception with freedom

from interference. These circumstances, coupled with the increased competition between manufacturers throughout the world, has necessitated a display of skill in design and workmanship which has had the effect of bringing the products of the British manufacturer into the front rank amongst the world's producers of wireless equipment, in spite of the fact that Britain was behind other countries in starting broadcasting.

CONTENTS.

	PAGE
EDITORIAL VIEWS	301
TWO VALVE FRAME-AERIAL RE- CEIVER	302
By F. L. Devereux.	
WJY AND WJZ	307
ACCUMULATOR H.T. BATTERIES	309
By A. P. Castellani.	
THE BRITISH ASSOCIATION MEETING	311
THE WIRELESS EXHIBITION	312
READERS' NOVELTIES	327
CURRENT TOPICS	329
THE CRYSTAL AMPLIFIER	331
By L. L. Barnes.	
BROADCAST BREVITIES	335
SPADE TUNING	337
LETTERS TO THE EDITOR	338
READERS' PROBLEMS	340

Two Valve Frame-Aerial Receiver

Self-contained Set
for the Local
Station.

By

F. L. DEVEREUX, B.Sc.

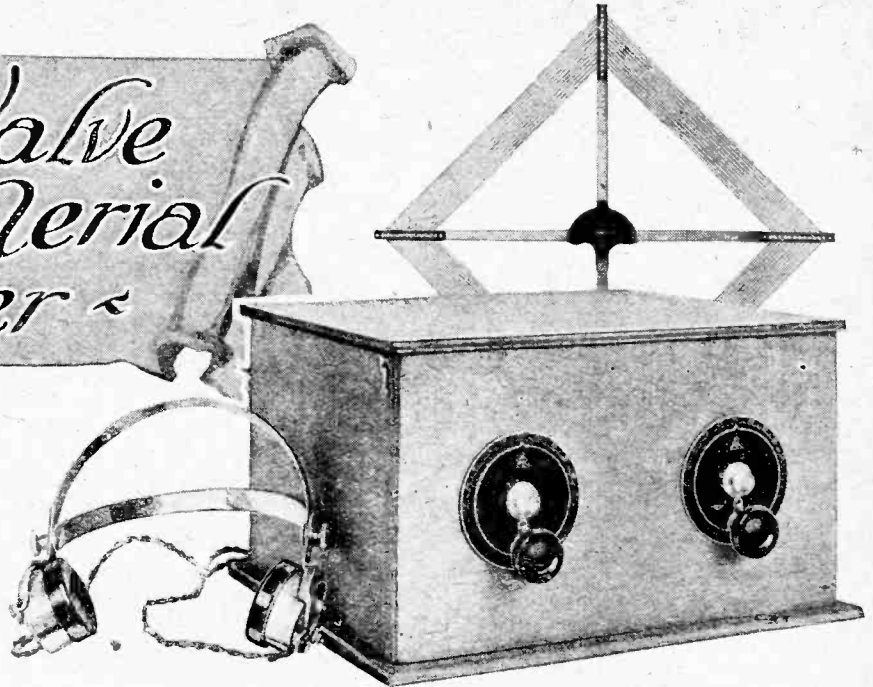

MANY potential broadcast listeners living in flats in our cities have not yet availed themselves of the broadcast services through their inability to erect an outdoor aerial. Frame aerial reception is associated with superheterodyne receivers and expense, and an idea has gained currency that an outdoor aerial is essential if only simple and inexpensive apparatus can be used.

Possibilities of Simple Frame Receivers.

It is this attitude towards frame aerial reception which accounts for the travesties of aeriels which festoon the housetops in every big town. The form and ceremony of the aerial are there, but the only function which it performs is to shock the susceptibilities of passers-by. If an efficient outdoor aerial is precluded and a superheterodyne receiver is too costly, it is as well to abandon all idea of long-distance reception and to build a set exclusively for the reception of the local station with a frame aerial.

Subsequent experience with the receiver described in the succeeding pages has shown that with two valves strong signals in four pairs of telephones can be received at a distance of twenty-five miles north of 2LO. The volume is uncomfortably loud at this distance, and can be heard with the telephones removed from the head. Reception is by no means confined to the local station, however, and Bournemouth, Birmingham, and a Spanish station have been received at the above situation. With patience and skill the range could be extended further, but it was not with this object that the set was designed, and these results are mentioned only to show that twenty-five miles is a conservative estimate for the local station.

Two 0.06 type valves are employed, and the set is, therefore, economical to maintain. A single charge costing about a shilling is sufficient to give an average daily service of two or three hours for a month.

An endeavour has been made to keep the receiver as compact and self-contained as possible. The batteries are all contained inside the cabinet, the only external components being the telephones and the frame aerial.

The Circuit.

A diagram of the circuit connections is given in Fig. 1. The first valve functions as a detector with reaction, and is followed by a low-frequency amplifying valve.

The filament current is controlled by two fixed resistances, R_1 and R_2 , and a variable filament resistance in the positive L.T. lead. R_1 is connected in the negative side of the L.T. circuit to prevent an excessive positive grid bias in the detector valve, and has a resistance of 20 ohms. The resistance of R_2 is reduced to 17 ohms by taking a proportionate number of turns off a standard 20-ohm resistance. The voltage across the detector valve filament with the battery fully charged and the variable

Fig. 1.—The circuit diagram.

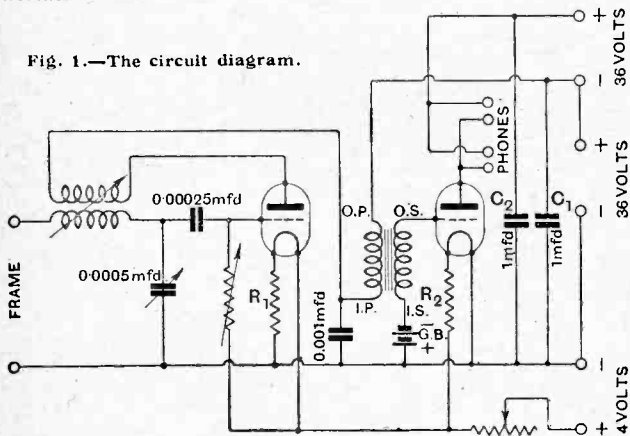

Two Valve Frame-Aerial Receiver.—

resistance all out will be 2.8 volts, and that across the amplifier 3 volts. This difference in the filament currents to the valves is necessitated by the difference between the H.T. voltages applied. Two 36-volt units are connected in series for the H.T. battery, giving 36 volts for the detector, and 72 volts for the amplifying valve.

The telephone terminals are connected in parallel, as the last valve has a low impedance.

Features of the Design.

The H.T. and L.T. batteries are housed in a separate compartment behind the front panel of the receiver, while the valves, variocoupler, tuning condenser, etc., are assembled in a compartment at the back. The input and output terminals to the receiver are mounted on the back panel in close proximity to the H.F. and L.F. components, and the set is controlled through the medium of ebonite extension rods by two "Apex" dials on the front panel. Thus the batteries, which are at "earth" potential as far as H.F. currents are concerned, act as a screen which considerably reduces the effects of hand capacity when tuning-in a signal.

The two L.T. accumulator cells are placed between the extension rods with the two H.T. units on either side.

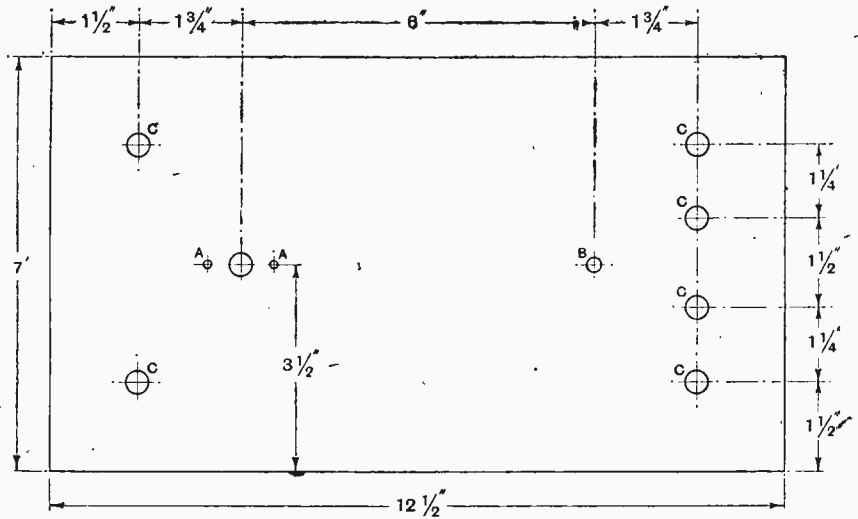

Fig. 2.—Drilling dimensions of back panel. The diameters of holes are as follow: A, 5/32in. dia.; B, 1/4in. dia.; C, 3/8in. dia.

If desired, strips of felt may be stuck to the top edges of the battery compartment to make an airtight joint with the lid. This will prevent acid fumes from corroding components in the rear compartment.

Constructional Details.

The deviations from the conventional American layout which have been made to secure compactness do not introduce any insuperable constructional difficulties, but the work of assembling the parts will be greatly simplified if a predetermined sequence is followed.

It is first of all necessary to construct the container, the leading dimensions of which are given (Fig. 5). The four sides and the middle partition are cut from 3/4 in. oak and are built together without the base, which is fitted, at a later stage. The front panel of the box is drilled with two 3/8 in. holes spaced 6 3/4 in. apart for the spindles controlling the variocoupler and tuning condenser. Holes of the same diameter are drilled in the partition in a corresponding position. The five holes near the top edge of the partition are for the flexible leads from the H.T. and L.T. batteries. A special drawing has been prepared for the drilling of the back panel, and is reproduced in Fig. 2. This panel carries the variable filament resistance, the variable grid

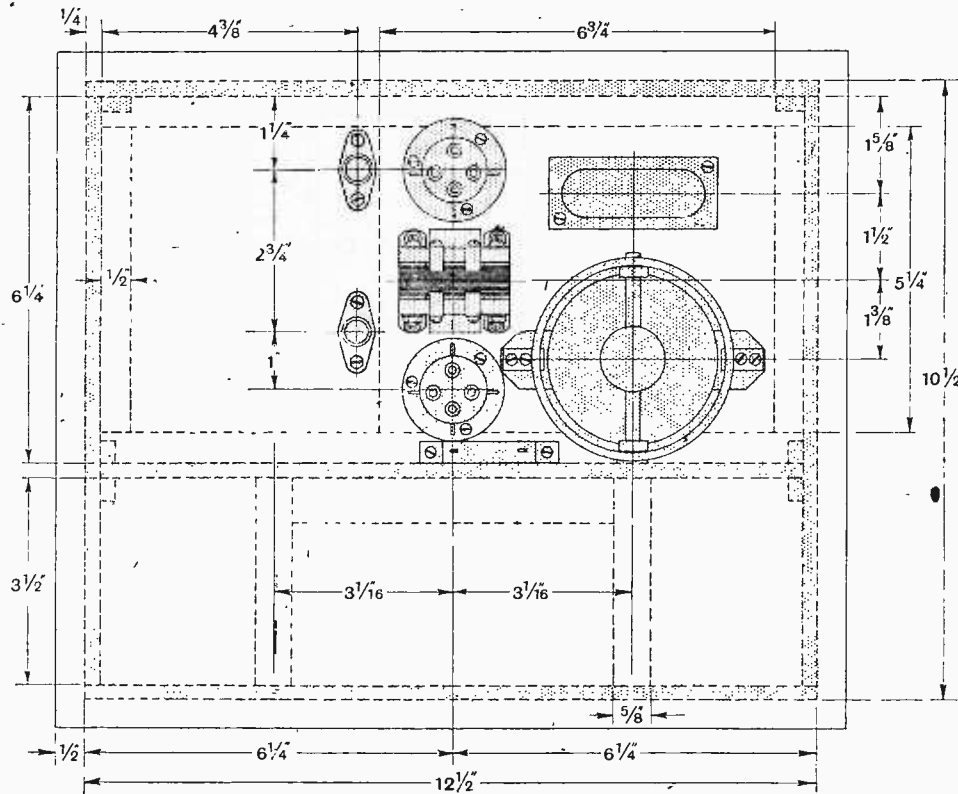

Fig. 3.—Layout of components on the base. The partitions between the H.T. and L.T. batteries are 2in. high and 5/8in. thick.

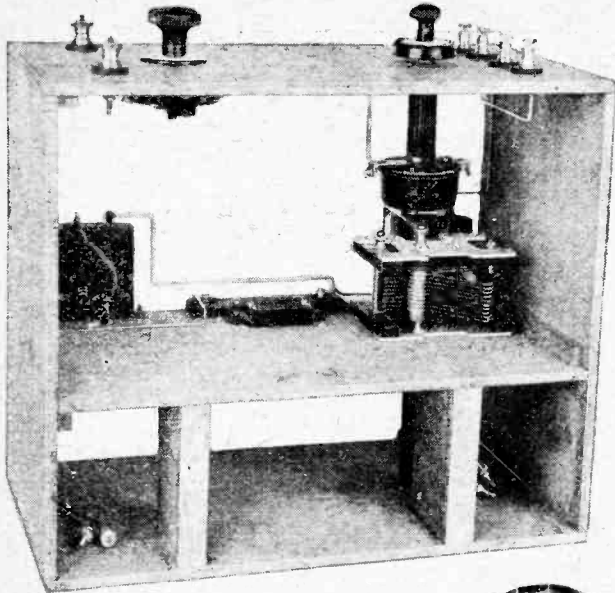
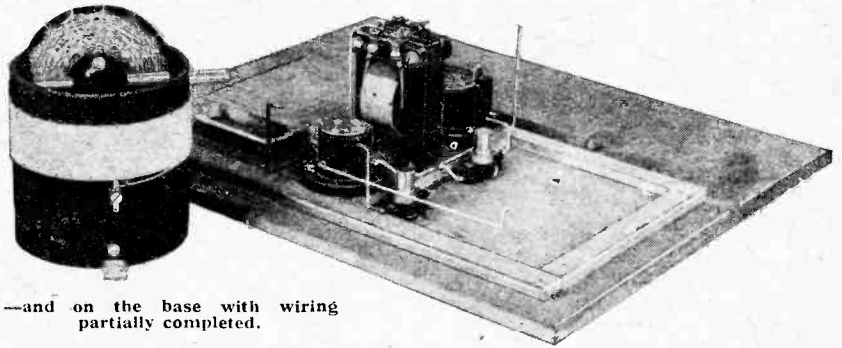

Fig. 4.—Components assembled in the container—

leak and terminals for the frame and two pairs of telephones. Fillets are provided to strengthen the corners of the box and to support the partition, the position of which is indicated by the dimensions given in Fig. 3. The base of the container measures $13\frac{1}{2}$ in. \times $11\frac{1}{2}$ in. \times $\frac{3}{8}$ in., and is provided with fillets fitting inside the larger compartment. It is strengthened, as indicated in Fig. 3, with a piece of $\frac{1}{4}$ in. wood $6\frac{3}{4}$ in. \times $5\frac{1}{4}$ in., to which most of the components on the base are screwed.

The lid of the box is cut from oak-faced three-ply wood and stiffened with battens running at right angles



—and on the base with wiring partially completed.

to the direction in which a tendency to warping is observed.

With the exception of the variocoupler and the ebonite extension spindles, the components can be purchased ready-made, and a list is given on a succeeding page.

Details of the Variocoupler.

The variocoupler is shown at the side of the base in Fig. 4, and consists of a basket reaction coil mounted to rotate in the end of an ebonite tube carrying the single-layer grid winding. The tube is $3\frac{1}{2}$ in. in external diameter and $3\frac{3}{4}$ in. long, and the winding consists of 25 turns of No. 22 S.W.G. D.C.C. Two $\frac{1}{4}$ in. holes are drilled diametrically opposite to each other and $\frac{3}{8}$ in. from the top of the tube to carry the reaction coil spindle, which is a $\frac{1}{4}$ in. brass rod $4\frac{1}{2}$ in. in length. The ebonite tube is fixed to the base with two brass angle brackets.

The reaction coil former is an ebonite disc $\frac{3}{8}$ in. in diameter and $\frac{1}{16}$ in. thick. There are fifteen equally spaced radial sawcuts, and the coil is wound with 100 turns of No. 28 S.W.G. D.S.C. A winding pitch of 4 has

been adopted in order to get the required number of turns into the available space; the wire, instead of being crossed over at every slot, is crossed every second slot. The finished coil is secured to the spindle with an ebonite block $\frac{3}{8}$ in. thick, which carries also the two soldering lugs for the flexible leads to the coil. Lateral movement of the reaction coil is prevented by two ebonite collars fitted to the spindle on the inside of the cylindrical former with grub screws.

The ebonite extension rods are each $3\frac{1}{4}$ in. long and $\frac{1}{2}$ in. in diameter with a central hole $\frac{1}{4}$ in. in diameter. As the spacing blocks between the batteries are $\frac{3}{8}$ in. wide, it will be seen that there will be $\frac{1}{16}$ in. clearance on each side between the extension rods and the batteries. Lateral holes are drilled in each end of the rods for grub screws and tapped for No. 6 B.A.

Two short lengths of $\frac{1}{4}$ in. rod are cut for the purpose of connecting the extension rods to the "Apex" tuning dials. The rods are bushed where they pass through the $\frac{3}{8}$ in. holes in the front panel by rectangular bearing plates $1\frac{1}{2}$ in. \times $\frac{7}{8}$ in. \times $\frac{1}{16}$ in. Holes are drilled in each plate for the $\frac{1}{4}$ in. spindles and also for the stop peg on the tuning dial, which is fitted $\frac{3}{8}$ in. below the bearing hole. Both plates should be recessed into the wood in order that the tuning dials may fit flush with the front panel. The bearings must not be screwed into position until the assembly and wiring of the components has been completed.

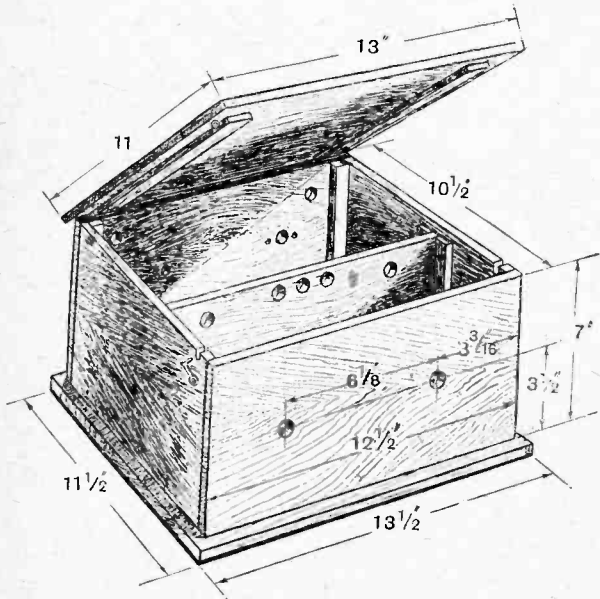

Fig. 5.—Leading dimensions of the container.

Two Valve Frame-Aerial Receiver.—

The components mounted on the back panel and partition can be mounted without delay. The 1 mfd. receiving condensers are screwed to the top of the partition opposite the two H.T. batteries. An ebonite terminal strip $3\frac{1}{2}$ in. \times $\frac{3}{4}$ in. \times $\frac{1}{4}$ in. carrying three soldering lugs is screwed in position between the reservoir condensers and immediately below this is the 0.001 mfd. by-pass condenser. The remaining component is the variable condenser. This may be screwed directly to the wood, since the end plates are at "earth" (-L.T.) potential. If the wood used for the partition is at all soft, a thin metal washer should be fitted under the "one-hole fixing" nut. Before fitting, a lateral hole should be drilled and tapped in the condenser spindle for the grub screw.

Assembly and Wiring.

The components fixed to the base include holders for the valves, fixed resistors and grid battery, the grid condenser, the L.F. transformer, and the variocoupler. The latter component should be screwed in position and then removed. This step will be appreciated when the variocoupler has to be screwed finally in position, as the screw holes will be already prepared.

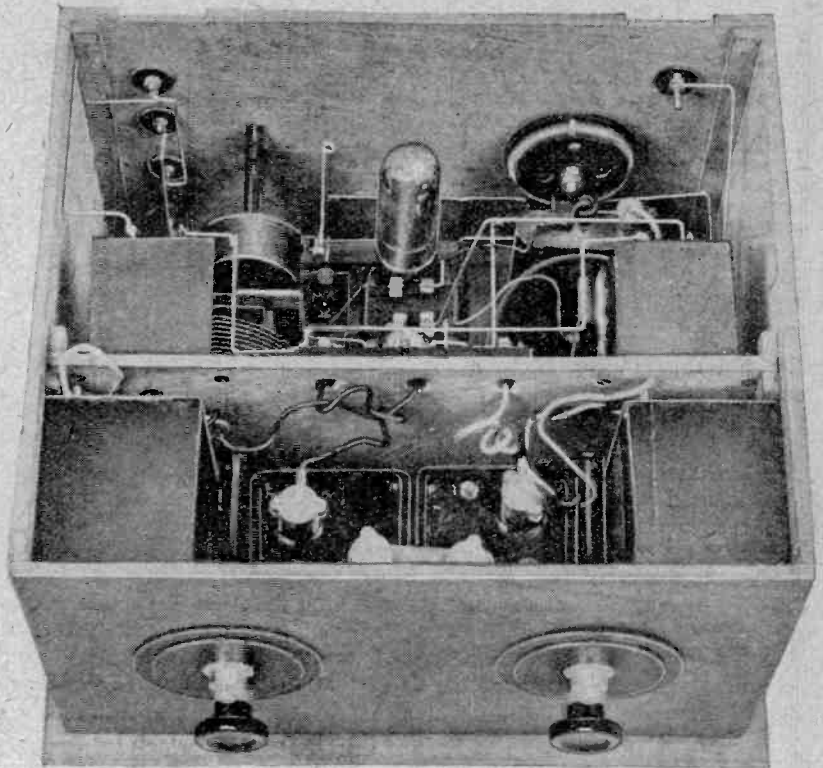

Fig. 6.—General view from front of finished receiver.

Now proceed as far as possible with the wiring of the components on the base and inside the container, leaving extensions where connections between the two groups are required. The photograph in Fig. 4 was taken at this stage.

The base is now screwed to the container and the variocoupler fixed in position with the reacting spindle projecting through the hole in the partition. It is best to lower the variocoupler into position with the wood screws resting in the brass brackets. The remaining connections to the variocoupler and between the components are now made. Flexible connections with spade terminals for the L.T. and plug connectors for the H.T. batteries are also fitted. It is convenient to use red braiding for the positive leads and black for the negative.

To complete the receiver it is now necessary to fit the extension rods and tuning dials. Before screwing the bearing plates to the front panel, the best average position is found by rotating the condenser vanes and reaction coil, as the case may be, with one hand, and feeling for any eccentricity in the movement of the plate with the other. In fitting the tuning dials care must be taken that the movement is limited by the stops in the dial, and not in the condenser. The geared movement gives great leverage, and the extension rods and bearings

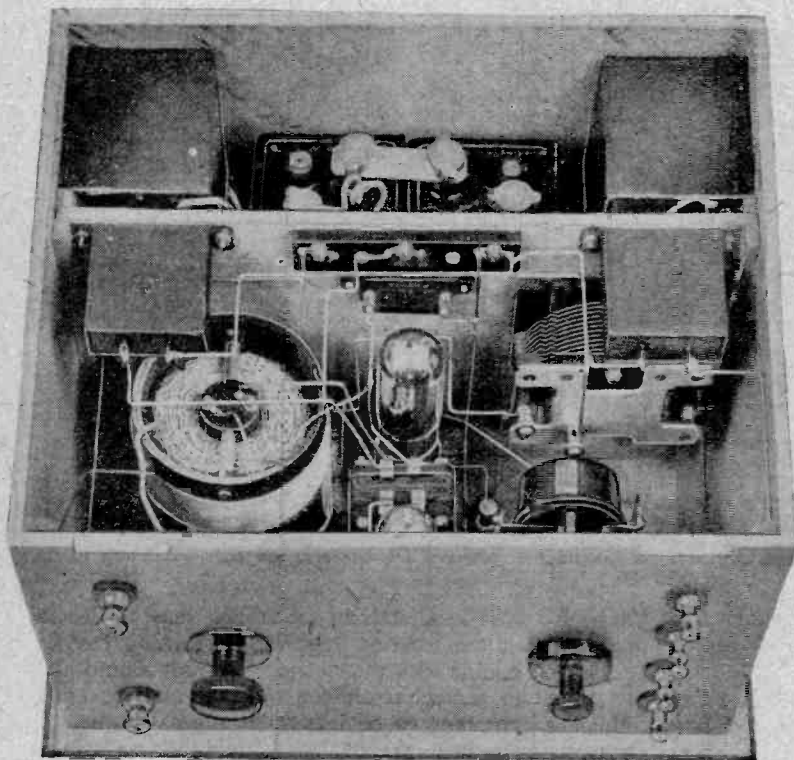

Fig. 7.—Rear view of the receiver with lid removed.

LIST OF COMPONENTS.

Oak for cabinet, $\frac{1}{2}$ in. and $\frac{3}{4}$ in. thick.
 1 Ebonite tube $3\frac{1}{2}$ in. dia., $3\frac{3}{4}$ in. long.
 1 Ebonite disc, 3 in. dia., $1/16$ in. thick.
 1 Variable condenser, 0.0005 mfd. (Ormond Low Loss, without vernier).
 2 Small "Apex" tuning dials.
 2 Reservoir condensers, 1 mfd. (T.C.C.).
 1 Fixed mica condenser, 0.00025 mfd. (Dubilier, Type 600A).
 1 Fixed mica condenser, 0.001 mfd. (Dubilier, Type 600).
 1 Variable grid leak (Igranic).
 2 Valve holders (Burndepl, No. 240).

1 Intervalve transformer, low ratio (Burndepl, No. 333).
 2 Fixed resistor holders (Burndepl, No. 718).
 2 Fixed resistors, 20 ohms (Burndepl, No. 720).
 1 Filament rheostat, 30 ohms (Burndepl, No. 274).
 2 H.T. batteries, 36 volts (Siemens, No. 827).
 1 Grid battery, $4\frac{1}{2}$ volts (Siemens, No. 990).
 2 2-volt accumulator cells (Exide, D.T.G.).
 1 A.R. 0.06 H.F. valve.
 1 D.E.3 valve.
 Terminals, ebonite bushes, $\frac{1}{4}$ in. brass rod, ebonite tubing, etc.

will be subjected to considerable strain unless this precaution is taken.

Testing and Operation.

A frame aerial consisting of 16 turns on a former 2ft. square is used with the set. To test, connect the batteries, telephones, and frame aerial to the set, turn on the filament resistance, and test across the filament sockets of both valves with a flash lamp bulb, or, better still, a voltmeter, to make quite sure that there are no mistakes in the wiring. If the normal L.T. voltage is registered, the valves may be inserted, the A.R.06 (H.F.) in the holder near the partition, and the D.E.3 at the back.

the signal strength. If there is a decrease, the connections to the reaction coil must be reversed.

Always work with the lowest setting of the reaction dial that will give adequate signal strength, and never allow the set to oscillate continuously, as this will not only destroy quality, but will affect neighbouring receivers, even though no outdoor aerial is used.

The quality of reception will be improved by decreasing the grid leak resistance to 2 megohms or less, but reaction will not be so smooth with the lower values, and 5 megohms should be used when searching for faint signals.

If signals are too strong, as they may well be expected

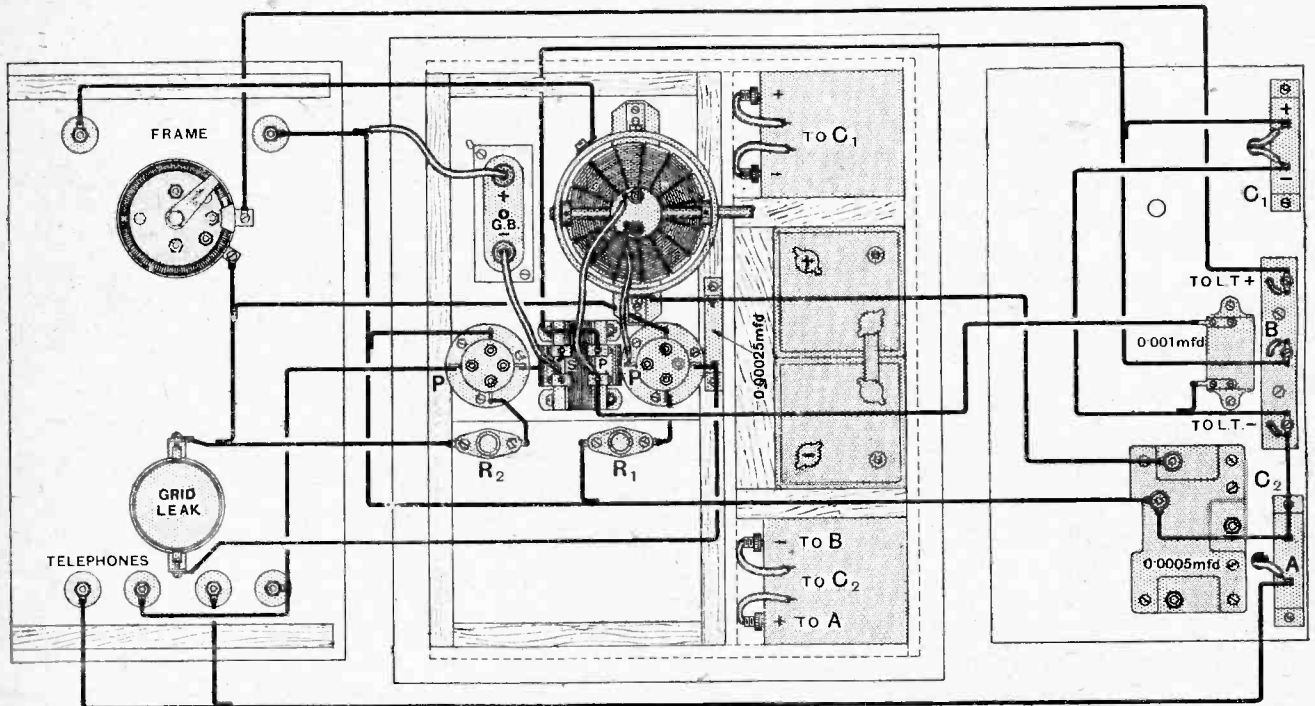

Fig. 8.—Complete wiring diagram. The components mounted on the middle partition are shown at the right-hand side of the diagram.

Set the grid leak to about 5 megohms and the reaction coil at right angles to the grid coil with a dial reading of 50, and switch on the valves.

With the plane of the frame pointing in the direction of the station, the right-hand tuning dial should now be adjusted, until signals are at maximum strength. Now increase the reaction coupling, and observe the effect on

to be from the local station, the volume may be decreased by reducing the reaction coupling or turning the frame aerial out of line with the station. The set should always be tuned to perfect resonance with the station, and the filament current must be left at its normal value. Any attempt to reduce volume by detuning or reducing the filament current will produce distortion.

W.J.Y. and W.J.Z.—
TWO UNIQUE AMERICAN
BROADCASTING STATIONS

A Brief Description of Two Well-known Stations which are Installed in the Same Building.

By A. DIMSDALE.

ABOUT two years ago it was decided to build a new and up-to-date WJZ in New York City, and, coincident with the opening of this new station about eighteen months ago, the old one was closed down. In view of the fact that it is impossible to provide a single broadcast programme which will please everyone, it was decided to build two stations on the same site, both aerials being suspended between the same towers. By separating the wavelengths sufficiently, mutual interference was to be eliminated, permitting of the simultaneous transmission of two programmes.

The original station WJZ was one of the pioneer American broadcasting stations, and used to be located in Newark, New Jersey, some twenty miles from New York City. It was then operated by the Westinghouse Company, and did a great deal of very valuable work, being one of the stations most consistently heard in England.

The Site of the Stations.

The site chosen for the two stations is the *Edolian Hall*, a giant skyscraper situated on 42nd Street, near Fifth Avenue, New York. The title photograph to this article gives an excellent view of the building and aerials. The aerials are of the inverted "L" type, placed back to back, separated and suspended together by means of a short length of insulated rigging. The effective height above the roof is about 100 feet, and the height above the street about 375 feet. Earth connection is made to the steel frame of the building, the water mains, and the pipes of the central heating system, which are all bonded together.

The transmitting apparatus is housed in a separate building specially built upon the roof, the studios, offices, and control rooms being situated on the tenth floor of the building.

The Transmitting Apparatus.

The output power of both WJY and WJZ is 500 watts, the former operating on a wavelength of 405 metres, and the latter on 455 metres. The entire apparatus for both



stations is duplicated, so that in the event of a breakdown an immediate change over to the reserve set can be made without interruption to the programme. One of the photographs shows the backs of all four transmitters, together with their respective generators and control switchboards. At the top of each panel are the four transmitting valves, mounted horizontally, in a framework which is suspended at the four corners on springs, in order to protect the valves from mechanical shocks and vibration which might cause microphone noises. All leads to the valves are flexible for the same reason. Beneath the valves can be seen the tuning inductances and aluminium cased Dubilier condensers. To the right of these latter, and a little below, is the transformer which supplies the high tension current for the plates of the valves. Underneath the transformer are the condensers and chokes which constitute the smoothing system for removing ripples in the rectified high tension current, so that a smooth direct current is supplied to the transmitting valves. The two smaller panels seen between the two end transmitters are the control panels. The four generators seen on the left are 5kW. machines, each transmitter having its own separate source of supply.

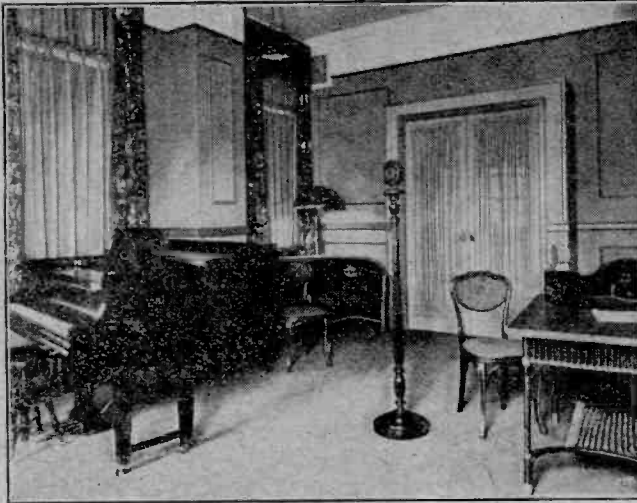

One of the studios at WJY.



Operators on duty in the transmitting room.

A wave trap in the aerial lead of the WJZ equipment eliminates interference between the two sets.

Of the three operators seen in one of the photographs, two are listening to the outgoing programmes of their respective transmitters. Their duty is to watch over the functioning of the transmitters (as distinct from watching the modulation, which is taken care of elsewhere) and correct any minor faults which may occur in the apparatus.

The third operator is complying with the American law which requires every broadcasting station near the coast to keep a watch on the ship wavelength of 600 metres. In the event of this operator hearing an SOS call from a ship in distress, the broadcasting station must immediately close down until the distressed vessel has been attended to and the all clear is given.

The Control Rooms and Studios.

Whilst broadcasting is in progress, an operator is stationed at the amplifier in the control room to listen to the outgoing programme, in order that the modulation shall be as nearly perfect as possible.

The old method of silencing studios with heavy drapings has now been discarded. The new way of deadening

sound in studios is to construct the walls of sound-proof material, making them double, and fitting double doors.

The modern American studio is comfortably furnished, and is as light and airy as a drawing room. Such arrangements in no way impair the reproduction of performances, and make a better and more encouraging setting for singers and artists of a nervous temperament. Each station has two studios. The reason for this is that whilst one item is being broadcast from one studio, the artists for the next item can be assembled and arranged in the other. In this way item follows item immediately, with no delay to the listener.

Two microphones will be observed in each studio. That mounted upon a stand is for use with general musical performances, and the one on the table is for the use of the announcer, and for lecturers, etc.

WJZ and WJY have now been in operation for about eighteen months, and are excellent examples of up-to-date American broadcasting stations, both as regards equipment and programmes. The programmes from each station are always different in character, so that if the WJY programme is not to the listener's taste, he can tune to WJZ, or *vice versa*.

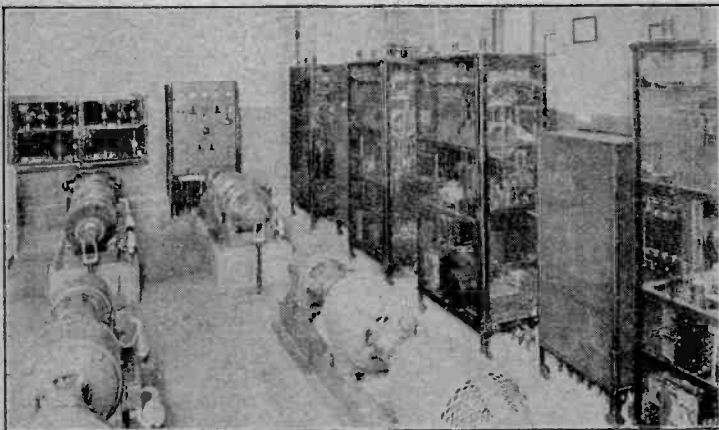

Duplicate transmitters and generators of WJY and WJZ.

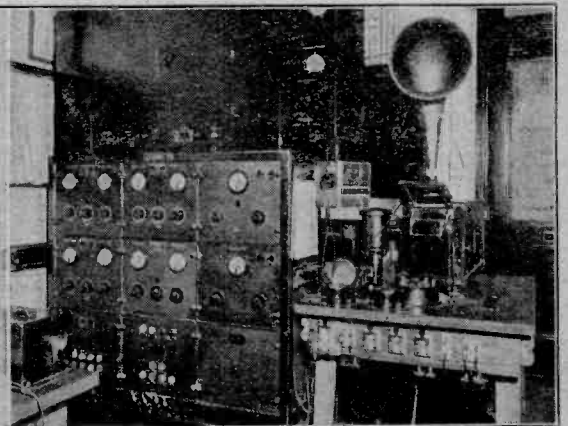

Modulation control room.

ACCUMULATOR H.T. BATTERIES.

Is their Use for Broadcast Reception Justified?

By A. P. CASTELLAIN, B.Sc., D.I.C.

THE problem of what to use for the high tension supply has to be met some time or other by all those who do any experimenting, and even those who merely listen-in and want good loud results. From a loud-speaker will sooner or later find out that the dry battery H.T. of usual size does not last very long if good quality speech is to be maintained.

the batteries, as, firstly, they are not more than two months old, and, secondly, there is a large condenser across the H.T.

This condenser across the H.T. is usually about $\frac{1}{2}$ to 1 mfd. in good sets, and is put there with the idea of stopping any tendency of the low-frequency valves to self-oscillation, or howling as it is usually called.

H.T. Battery as a Source of Distortion.

As regards the last statement, it does not seem to be generally known that an overloaded H.T. battery is a very common cause of bad quality speech in a loud-speaker. Most people like to get as much output from their sets and loud-speakers as possible, and usually over-run them badly.

At first, when all the batteries are new, everything is probably satisfactory, but as time goes on and the internal resistance of the H.T. battery increases, the quality of reproduction suffers and goes from bad to worse.

The author has many times been asked to find what is wrong with a set which has gone off in quality of reproduction—in many cases a few weeks after it was bought or made—and in nearly every case the trouble has been found to be due to the H.T. battery being overrun.

The author has also often been told by the owner of a set which is giving quality trouble that it cannot be

When a dry battery gets old and exhausted its resistance increases enormously—after a few months of hard use the resistance of an average 60-volt battery may be several thousand ohms. This resistance, in the absence of a shunting condenser, is usually quite enough to couple the low-frequency valves together and make them howl, giving a high-pitched note in the loud-speaker.

A condenser of one microfarad will have an impedance (or effective resistance) of about a hundred ohms only, at a frequency corresponding to the howling note, and thus when it is put in parallel with the battery will reduce the total effective resistance to the order of a hundred ohms, which will not give sufficient coupling for the valves to oscillate.

Fluctuations in H.T. Voltage.

The reader may ask at this point why the addition of a condenser across the H.T. battery will not remove any

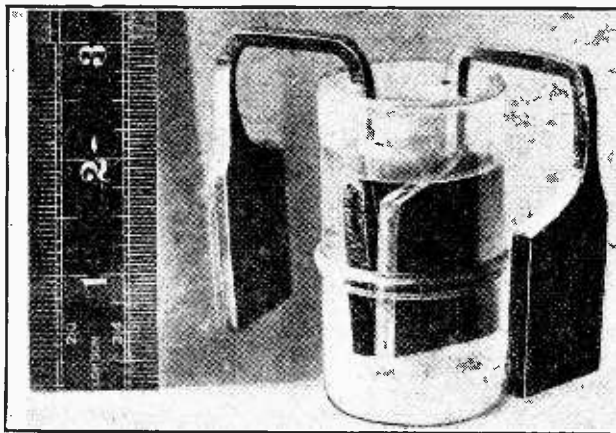

Accumulator cell designed for use in H.T. batteries. Positive and negative plates are built in pairs to avoid joints between the cells.

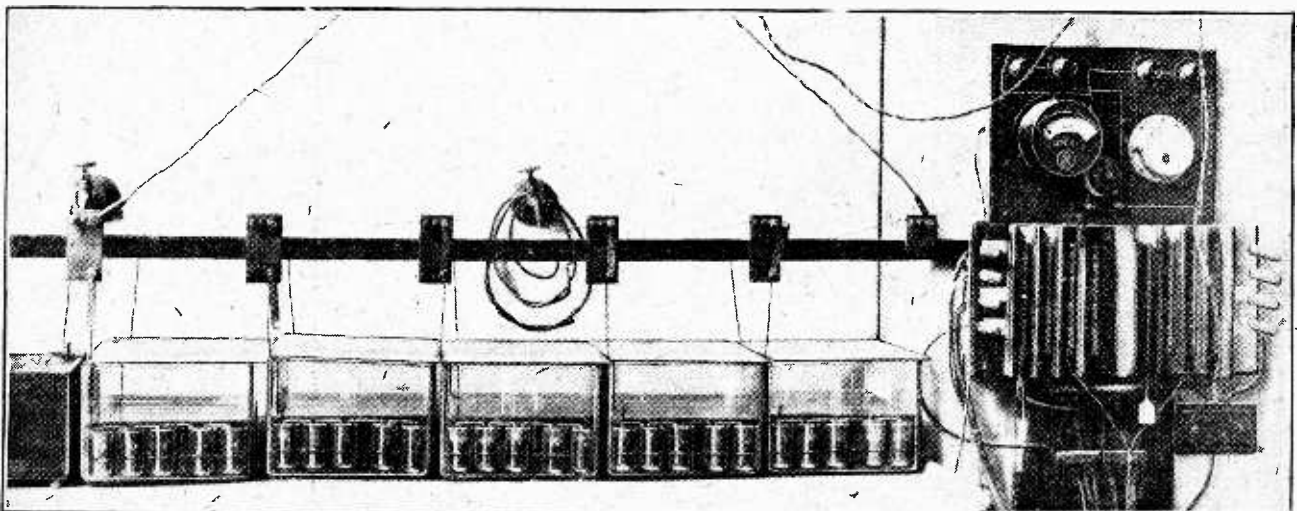

Complete H.T. battery installed in the laboratories of the City and Guilds Engineering College, London.

Accumulator H.T. Batteries.—

distortion effects due to the battery if it will stop the set from howling.

This may partly be answered by another question, Is it reasonable to expect distortionless output when the resistance and hence the voltage of the H.T. battery not only depends on the current taken from it, but also on the frequency which is being amplified?

An ideal valve amplifier should be supplied with constant H.T. voltage: otherwise, how can the output current vary exactly in accordance with the input voltage? It will be seen that this implies a source of H.T. of negligible resistance.

To attempt to get over the high resistance and varying voltage of a dry battery by using parallel condensers would necessitate the use of several hundred microfarads—which is, of course, an impracticable solution.

The author has found that for the ordinary local broadcast set, using two or perhaps three valves and a loud-speaker, and the last valve being a small power valve for good quality reception, the ordinary size H.T. battery does not "last," as far as good quality reproduction is concerned, for more than two months with average use of the set.

This makes the H.T. problem quite a serious one to many people who want good quality reproduction and not just noise, especially if high voltages are used, as they should be for good results. One solution is to use H.T. units with larger cells; these will last longer, but are very expensive, although cheaper in the long run than the usual small type. Another solution, and by far the best and cheapest in the author's opinion, is to use H.T. accumulators. Most people seem to think they are letting themselves in for endless trouble and expense if they use accumulators for H.T.; but this is not by any means true if they set about it the right way.

First of all, it is necessary to obtain the battery, and the reader is strongly advised to buy one of reliable make. The average price is a shilling a volt, which means an outlay of about six pounds. This seems a lot, but when it is considered that such an accumulator will last with ordinary care at least five years, and that a single 120-volt of the usual dry cell type costs about 25s., making about five pounds a year for H.T. alone, the accumulator is seen to be much cheaper.

The accumulator may easily be charged from the local mains, whether D.C. or A.C., at very small cost indeed. For the transmitting experimenter, the type of accumulator illustrated in the photographs is recommended.

For convenience, the battery is split up into 60-volt units, each unit consisting of 30 small "Hart" elements in glass cells standing in a large glass or lead-lined wood container.

After each cell has been filled with acid of the correct density, oil is poured over the whole until the cells and their connections are completely immersed in it. The only oil which has been found to give complete satisfaction is Price's "Blancol." On no account should any other untried oil be used, as it will be almost certain to attack the lead or be attacked by the acid.

This particular method of using oil is due to Professor Mallett, of the City and Guilds Engineering College, and the batteries illustrated have been in successful use in the College laboratories for some time.

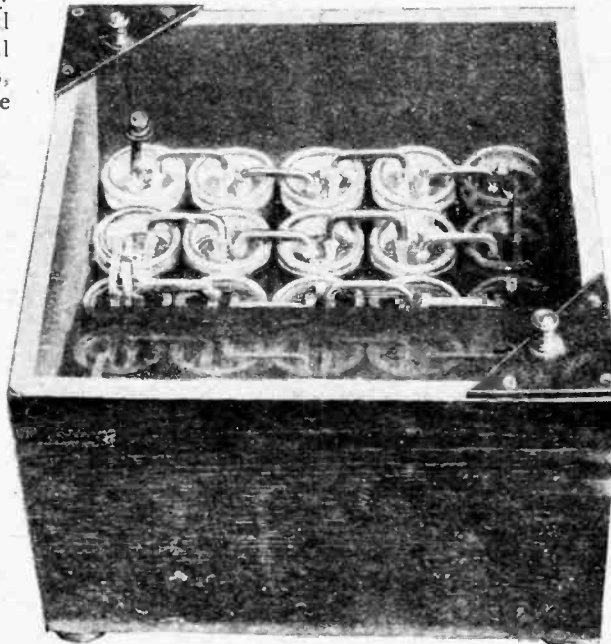

Accumulator H.T. battery assembled in lead-lined wood container. The battery is tilted forward and the oil is covering the front rows of cells.

Charging.

There are one or two points to be noted in connection with H.T. accumulators in common with other types of lead-acid cell.

While the final voltage and specific gravity of the acid of the cells may vary with the type and rate of charge, there is one thing true of all types: namely, that the charge is not quite complete until constancy of voltage and specific gravity has been obtained, the actual values being to a large extent a secondary consideration.

The first charge should not be stopped until the readings show this constancy for a period of five to six hours. The gassing of a cell when the charge is quite complete

differs from that observed in the earlier stages. Before the charge is complete, the bubbles are small, and, coming off in large numbers, give the cell a milky appearance. When the cell is fully charged the bubbles are larger and, looked at from the top, the acid appears practically clear.

Maintenance of Acid Level.

In the first mixing of the acid or subsequent making up for evaporation, or "topping up" as it is called, we used distilled water, *never* tap water. The impurities present in tap water will make short work of the positive plates of the accumulator, and if iron is present both plates will be affected.

The author has found these accumulators very reliable in use; the only attention needed after they have been properly filled is regular charging, so that they never become discharged below 1.8 volts per cell. As H.T. for a broadcast set they are ideal, and the charge lasts from two to three months, and once properly installed should give no further trouble for at least five years beyond systematic charging and topping up.

THE BRITISH ASSOCIATION MEETING.

Subjects of Radio Interest.

By OUR SPECIAL CORRESPONDENT.

THE meeting of the British Association for the Advancement of Science, August 26th to September 2nd—the ninety-fifth of a series of annual meetings—which has just concluded at Southampton, has been, in some respects, of more than usual interest to the wireless engineer and experimenter, and also to the broadcast listener who takes more than a cursory interest in wireless problems.

Among subjects of wireless interest, Professor Appleton contributed a paper to the Physical Science Section, dealing with "Some Thermionic Valve Problems," explaining the static characteristics of the valve—a paper which must have an important bearing on the theoretical problems of valve design. In the same section Dr. Smith-Rose, of the National Physical Laboratory, dealt with some very recent work carried out at the National Physical Laboratory, for completely determining the magnetic, as well as the electric, forces in wave propagation.

It is part of the Association's programme to arrange lectures of a more "popular" nature for the benefit of local citizens. Two of the four Citizens' Lectures this year were devoted to broadcasting—one by Capt. P. P. Eckersley, entitled "Some Technical Problems of Broadcasting," the other by Professor E. V. Appleton, on "The Rôle of the Atmosphere in Wireless Telegraphy." Both of these lectures have been reported at length in the daily Press.

In the section devoted to geology, reference was made by Professor J. W. Gregory, F.R.S., to the important contribution of wireless time signals in settling the question of whether continents are really drifting over the earth. The instant of sending from one station and receiving the same time signal at a distant station should

only differ by a very small fraction of a second of time. Larger discrepancies than the theoretical values have, however, been noticed, and in particular these discrepancies have been used by Wegener to give support to his theory that Greenland is drifting from the position it formerly occupied in longitude.

The subject of wireless time signals was also touched upon by Mr. A. R. Hinks, C.B.E., F.R.S., in his Presidential address to the geographers. Having referred to the pioneer work of the Bureau International de l'Heure, and the early practical help afforded by the French wireless stations through the interest of General Ferrié, he urged the establishment of a British time signal service to be sent out through the Imperial Wireless Chain in the following words:—

"We have—or shall have soon—an 'Imperial Wireless Chain' stretched out from the new station at Rugby to the furthest Dominions; and we shall miss a great dramatic opportunity if from the opening of this service we do not insist that time signals from Greenwich shall be sent from Rugby and retransmitted in each link of the chain, that all Britain's Dominions beyond the seas, her ships on the ocean, and her travellers wherever they may be, shall be able to take Greenwich Mean Time direct from the source."

One of the earliest practical uses to which wireless was put was that of collecting weather observations from remote parts of the world. An exhibit illustrating exactly how weather information is collected by wireless and forecasts are prepared has formed an integral part of the British Association's meetings for the past three or four years. A receiving set was installed at Southampton in full view of members, and weather reports received

in code from wireless stations in Belgium, Holland, Denmark, Norway, Sweden, France, and the Air Ministry, London. As soon as received, the weather data was charted by an officer seen in the foreground of the photograph, and from the completed map a forecast prepared by the Meteorological Officer in charge, Mr. J. Durward. Printed copies of the weather map and forecast were in the hands of visitors by 10.30 each morning, the final link in the wireless weather service being undertaken by scouts from the Southampton district, who posted the forecasts in various parts of the town.

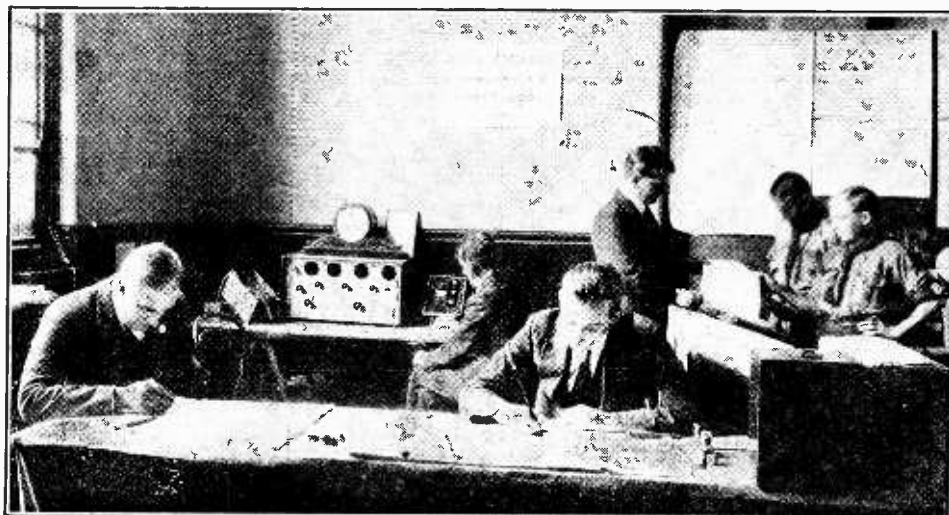

The Meteorological Officer handing a forecast to scouts for distribution.

N.A.R.M.A.T.

WIRELESS EXHIBITION

A GUIDE TO THE SHOW.

In addition to serving as a guide when inspecting the stands, the details given indicate the trend in broadcast receiver design and the developments taking place in the range of components and accessories.

The principal exhibits to be seen at the stands are briefly described, making reference mainly to those products which are now shown for the first time, though not omitting standard products which are already in general use and which are to be continued in their present form.

STAND No. 1, also LOGGIA Nos. 59 & 60.—THE BRITISH THOMSON-HOUSTON CO., LTD., Crown House, Aldwych, London, W.C.2.

Crystal Receiver Type "A."—High-class crystal receiver in well-finished walnut case, variometer tuned and fitted with double detector.

Bijou Crystal Receiver.—Cheap though well-constructed crystal set, variometer tuned and capable of giving good results. The tuning range, like the type "A," is 300 to 500 metres, and an efficient tuning coil device is supplied for the reception of Daventry.

Valve-Crystal Receiver.—A cabinet receiver totally enclosing both valve, a B5, and high-tension battery, forming a neat and compact set. The fitting of a double crystal detector with two-way switch is a most useful feature. A reflex circuit is employed. Dry batteries will operate the set, which is tunable to the 300-500 metre broadcasting waveband, and to 1,600 metres by means of a loading coil.

Two-Valve Receiver.—Developed to be a cheap and efficient receiver. The circuit embodies a detector valve with an interesting reaction arrangement followed

**Viscount Wolmer,
Assistant Post-
master General,
who
will open the
Exhibition.**



Photo:
Elliott and
Fry.

by a low-frequency amplifier. Gives loud-speaker results from a local station and receives Daventry with the addition of a loading coil and reaction unit.

Two-Valve Cabinet Receiver.—Employing a dual amplifying circuit, the set is totally enclosed, and includes both L.T. and H.T. batteries.

Three-Valve Cabinet Receiver.—Of artistic design, the cabinet contains both L.T. and H.T. dry batteries as well as the loud-speaker, so that the only external connections are the leads to aerial and earth. The circuit is a two-valve reflex arrangement followed by a note magnifier. By the use of loading coils signals on longer wavelengths than the 300-500 metre band can be received.

Three-Valve Portable Superheterodyne Receiver.—This receiver is intended for reception out of doors, or in flats or similar locations where the erection of an external aerial is impracticable. A plug is provided for connecting up an external frame aerial to improve the receiving range. As a superheterodyne the set is, of course, highly selective, and is unique inasmuch as the 1,600 metre wavelength is embraced in the tuning range by means of additional coils.

Six-Valve Cabinet Receiver.—The set is entirely self-contained, no external connections whatsoever being required, as the tuning panel, frame aerial, H.T. and L.T. batteries and loud-speaker are contained within the cabinet. An unusual feature is the provision of two frame aerials at right angles to each other, fitted inside the cabinet, either of which can be brought into operation by means of a switch. This is to overcome the need of rotating the set in order to roughly point the plane of the frame in the direction of the transmitting station for best reception. The calibration of the set remains constant, and tuning difficulties are overcome by the inclusion of a carefully compiled table of dial settings. The containing cabinet can be supplied in various styles.

Single and Two Stage Amplifiers.—Fitted with new type transformers and dual rheostats for bright or dull emitter valves. Grid bias connecting leads are provided.

Unit Amplifier.—Consists of a pedestal of moulded insulating compound, the top of which forms the valve holder while the base carries an internal transformer. The necessary connections are arranged to be reversible, as the makers intend that two or more units should be linked together to form a multi-stage amplifier.



at the
ROYAL ALBERT HALL

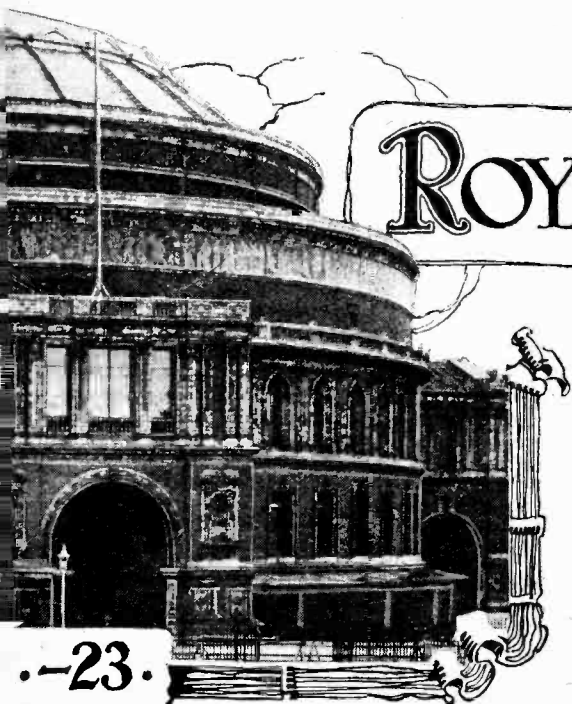

-23-

STAND No. 3.—S. G. BROWN, LTD., Victoria Road, North Acton, London, W.3.

STAND No. 4.—THE M.O. VALVE CO., LTD., Brook Green, Hammersmith, London, W.

Over twenty different types of valves for reception purposes are exhibited, and their suitability for use in particular circuits may be determined by a perusal of the technical pamphlets giving characteristic curves and data. Small transmitting valves for experimental use are of particular interest, whilst high-power transmitting and rectifying valves, including those with water-cooled anodes, may be inspected.

STAND No. 5, also LOGGIA No. 67.—RADIO COMMUNICATION CO., LTD., 34-36, Norfolk Street, London, W.C.2.

Can Vernier Coil Holder.—The coil holder is manufactured in two models for accommodating two or three tuning coils, the two-way type being made with both left- and right-hand movement. Another model, the "N" type, is a two-way holder, and has the additional feature of being equipped with rubber rings so that the moving coil can turn through an angle of 180°.

Polar Variable Condensers.—The well-known model has been modified, and recent improvements include the provision of a bevelled dial with the abolition of the pointer. The dial is made of metal, and acts as a capacity shield. An interesting new type of variable condenser is a square law instrument in which allowance has been made in the shape of the plates for the inherent capacity of the tuned circuit, so that the relationship between scale reading and wavelength is almost truly proportional. A feature in the design of the condenser is that the vernier movement is operated by the same knob as the ordinary movement, and that the scale moves with the vernier, which is not the case when a vernier adjustment is provided by means of an extra vane. The Polar Junior condenser is another model which has been produced to meet the demand for a really cheap and reliable variable condenser, and is obtainable in several capacities. A micrometer condenser is also available, and the "N" type is an improved model, though designed on the same general principles as the well-known Polar Micrometer condenser. It is well finished, has a long ebonite handle and locking nut, and is particularly suited for use in neutrodyne circuits.

Portable Amplifier and Loud-Speaker.—A most useful instrument entirely self-contained and suitable for coupling up to a receiving set. It is a companion set to the B.T.H. three-valve portable receiver. By means of break jacks, head telephones may be plugged in in place of the self-contained loud-speaker, and the dry battery for filament heating may be substituted by an external battery.

Loud-Speakers, Types C1, C2, C3, C5, C3, D and E.—Various models are shown, all of reliable construction and original in design, introducing features of special merit. Fitted with adjustable air gap, the range includes, in addition to several trumpet models, a gramophone attachment, an elegant table lamp which disguises effectively the formal lines of the ordinary loud-speaker, and an electro dynamic instrument (type "D") with moving coil floating in a permanent magnetic field. The type "E" loud-speaker is entirely new, and is an efficient instrument of unobtrusive yet decorative appearance. Its diaphragm is unsupported at the periphery so as to eliminate resonance.

Head Telephones.—Weighing only 9½ oz. with cords, the B.T.H. headphones have reached a high standard of design. The head-band is leather covered, which combined with entire absence of screw adjustments permits of the telephones being worn for hours without discomfort or becoming entangled in the hair.

B.T.H. Valves.—These are too well known to receive detailed individual reference. The types include the "R," B3, B4, B5, B6, and B7. To judge the merits of the several types and their suitability to function in various circuits, reference should be made to B.T.H. technical pamphlets available at the stand.

Low-Frequency Transformers.—The windings, which are now available in ratios of 2 to 1 and 4 to 1, are carried on moulded spools. The core is well designed and of generous dimensions. It is apparent that considerable attention has been given to the design of this component before placing it on the market.

Variable Condensers.—Three types are supplied, the standard model, square law and standard type with vernier, in capacities of 0.00025, 0.0005 and 0.001 mfd. The construction provides robustness and a smooth movement combined with good electrical design.

STAND No. 2.—CABLES & ELECTRICAL SUPPLIES, 234, Pentonville Road, London, N.1.



Mr. W. W. Burnham, Fellow I.R.E., Chairman of the trade association organizing the exhibition.

N.A.R.M.A.T. Wireless Exhibition.—

Resistance Capacity Coupling Unit.—Consists of a wire wound resistance spool, Dubilier condenser, and a grid leak, assembled in a compact manner, and arranged for easy mounting in a low-frequency resistance coupled amplifier.

Polar Rheostats.—An improvement on former models is the fitting of a much simpler contact between the resistance wire and the brushes. The special merit of this component is that resistance spools can be interchanged almost as easily as changing a valve, so that any type of valve may be employed without involving structural alterations.

Polar Receiving Sets.—The Polar "Twin" is a popular valve set which can be supplied if desired in an attractive oak cabinet, and contains all necessary batteries. Various types of Polar Blok sets are now supplied ready assembled and complete in every detail. The Polar "Four" is a noteworthy addition to the range of Polar sets, and is a four-valve receiver in which the tuning circuits are duplicated so that two stations may be separately tuned in, and by means of switching arrangements either one or the other can be used at will. It is provided with remote switching control which, as well as bringing the set into operation as required, operates the change wave switch. The circuit arrangement is a detector valve with three resistance capacity coupled low-frequency stages.

STAND No. 6.—L. McMICHAEL, LTD., Hastings House, Norfolk Street, Strand, London, W.C.2.

Receiving Sets.—The range includes an attractive two-valve receiver with high-frequency amplifier. A two-valve power amplifier of similar outline to the two-valve receiver is a companion instrument. As a self-contained instrument the three-valve receiver is fitted with similar controls to the two-valve set and includes a note magnifier. The standard "De Luxe" broadcast receiver is an attractive four-valve cabinet set with self-contained batteries. Five different types of sets for

home assembly are available, and include a range of reliable components which can easily be put together, forming attractive receivers. A two-stage amplifier is included in this range.

H.F. Transformers.—Messrs. L. McMichael, Ltd., have specialised in the manufacture of high-frequency transformers, and their well-known design scarcely requires description. A wavelength range of 80 to 7,000 metres is covered by six transformers when tuned with a condenser of 0.0003 mfd. capacity. Another type of transformer is available for obtaining a neutralising potential as required in the neutrodyne circuit. The utility of these transformers is extended by the provision of a reactor and damper by means of which it is possible to critically control the extent of self-oscillation set up in the tuned circuits.

Fixed Condensers.—The flat type condenser when mounted in clips can be interchanged rapidly and, if necessary, transferred from one set to another without disturbing connections. By means of a panel carrying four sets of clips, four condensers can be assembled in parallel to provide a capacity change from 0.0001 to 0.0015 mfd. in steps of 0.0001 mfd. Small ebonite panels are available carrying clips for mounting grid condenser and leak. The range of McMichael components includes square law variable tuning condensers, neutrodyne and vernier condensers, L.F. transformers with clips for bridging condenser, single, double and triple filament rheostats, potentiometers, and coil holders.

STAND No. 7.—GENT & CO., LTD., Faraday Works, Leicester.

"Tangent" Tuning Coils.—Coils of unusually low self-capacity, constructed with a special form of winding, and mounted on the standard plug-in coil holder. The properties of "Tangent" coils are described in a report by the National Physical Laboratory, obtainable at this stand.

"Tangent" Discol H.F. Transformers.—When tuned with a



Fig. 1.

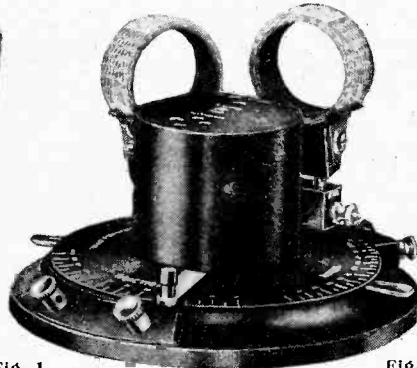

Fig. 2.

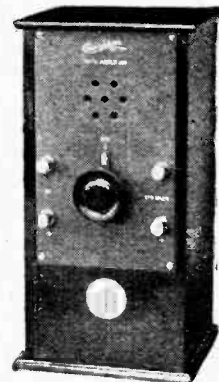

Fig. 3.



Fig. 4.

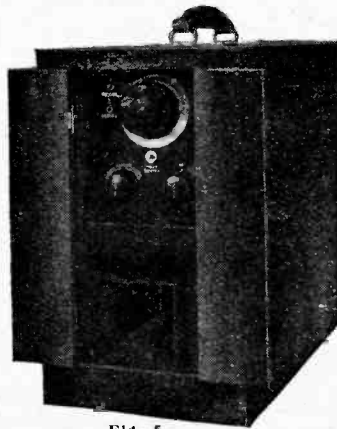

Fig. 5.



Fig. 6.

Fig. 1. Low loss crystal set. National Wireless Electrical Co., Ltd. Fig. 2. Ediswan crystal receiver. Edison & Swan Electric Co., Ltd. Fig. 3. Type 7a Chakophone amplifier. Eagle Engineering Co., Ltd. Fig. 4. G.E.C. crystal set. Fig. 5. Pelican portable receiver. Pell Cahill & Co., Ltd. Fig. 6. Ericsson receiving set.

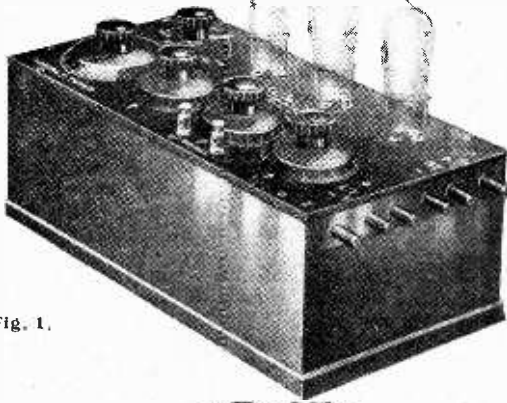

Fig. 1.



Fig. 2.

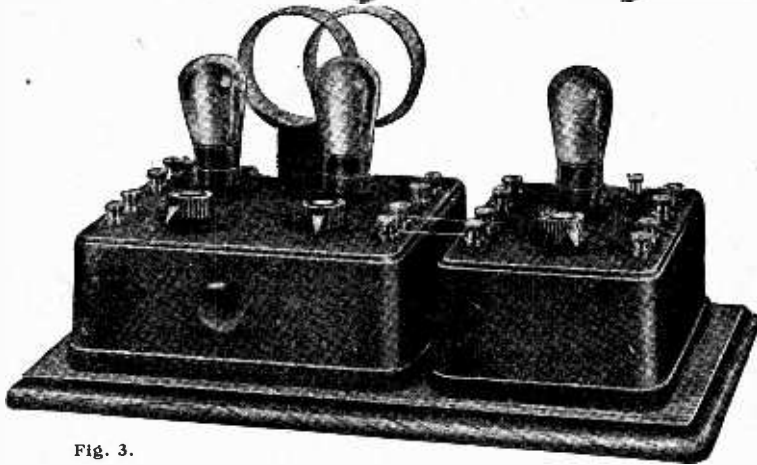

Fig. 3.

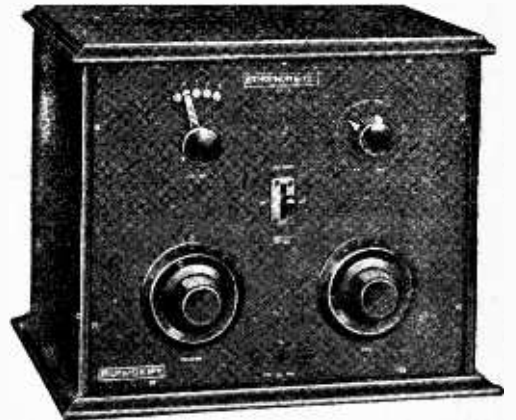

Fig. 4.

Fig. 1. Climax superheterodyne. Climax Patents Ltd. Fig. 2. Single valve receiver. National Wireless Electrical Co., Ltd. Fig. 3. Two valve receiver and note magnifier. Burndept Wireless Ltd. Fig. 4. Ethophone III. Burndept Wireless Ltd.

condenser of capacity 0.0002 mfd. each transformer covers a wavelength of approximately 100 metres. The mounting cheeks are made from solid ebonite, and brittle mouldings liable to crack or break are avoided.

"Tangent" Type "D" Receiver.—Specially designed for reception from the new Daventry Station. A two-valve set with valves and coils located behind the panel and a tuning range which includes all B.B.C. stations. Possesses good selectivity, and is provided with adjustable reaction.

"Tangent" A.C. Rectifier.—An interesting instrument for providing H.T. supply from A.C. mains, fitted with step-up and step-down transformers and a simple smoothing circuit. The rectifying valve employed is an ordinary receiving valve with the grid and plate pins bridged.

Synchronisation of Electric Clocks by Wireless. A master clock automatically switches on the valves of the receiving set thirty seconds before the Eiffel Tower or other time signal, and at the same time opens the aerial-earthing switch. An intricate instrument termed the Code Selector discriminates between the warning signal and the time signal proper. The action of synchronisation earths the aerial, switches off the valves and resets the selector for the next time signal. In the absence of Paris time signals this apparatus is demonstrated by means of a buzzer.

Components.—The range of "Tangent" components includes filament rheostats, loud-speakers, head telephones, and other accessories to meet experimental requirements.

STAND No. 8.—METRO-VICK SUPPLIES, LTD., Trafford Park, Manchester.

"Cosmos" Crystal Set.—A compact instrument with a tuning range for the B.B.C. stations, including the high power

station. Tuning is effected by a variable condenser, and an unusual though very desirable feature is the provision of contacts so that the detector and telephones can be bridged across either one-third or two-thirds of the full inductance.

Three-Valve Receiver.—The first valve is reflexed followed by a detector valve and note magnifier. The tuning range is from 250 to 560 metres and from 1,300 to 3,000 metres. The approximate range for loud-speaker reception is given as about 50 miles from a main B.B.C. station, and 150 miles from the high power station.

Five-Valve Cabinet Receivers, Types V.S.5, V.S.6, and V.S.7.—For reception of all wavelengths in use for broadcast telephony. The tuning ranges are controlled by plug-in units, three of which cover the range 300 to 3,000 metres. The aerial inductance, the H.F. intervalve transformer, and the reaction coil are all changed simultaneously, the reaction coil being arranged to couple either with the aerial or H.F. transformer windings. The circuit is a dual amplification arrangement. Filament rheostats are double wound so that any type of valve may be employed.

Cosmos Three-Valve Amplifier Panel, Type A.5.—This comprises three resistance coupled valves, and is fitted with a switch so that the last two valves may be connected either in cascade or parallel.

Components.—The Cosmos square law variable condenser is designed to reduce losses to a minimum. The moving plates being connected to the end plates, and the fixed plates supported by strips of ebonite outside of the intense electrostatic field. Adjustable cone bearings of hardened steel regulate the spindle friction, so that the plates can be arranged to stay in position when the condenser is mounted edgewise, while

N.A.R.M.A.T. Wireless Exhibition.—

reliable contact is ensured by a pig tail connection. An attractive knob and dial enhances the appearance. Other models are fitted with a slow motion movement operating through a 10 to 1 reduction gear with absence of back lash. Cosmos inductance coils are strip wound and embedded in a specially prepared paper, are light in weight and very robust, and can be relied upon to possess low self-capacity. The short wave coils have parallel connected windings. Among other components might be mentioned the Cosmos rheostats and potentiometer with windings carried on a porcelain bobbin, Cosmos "Permacons," which are small fixed condensers in nickel-plated cases, grid leaks, transformers, crystal detectors, lighting protectors, anti-vibration valve holders.

Cosmos Valves.—Valves manufactured by this company include the D.E.11 (0.25 amp. at 1.1 volts), the A.45 (bright emitter), and the S.P.18 (2-volt power valve), all of which are general-purpose valves, though special types are available for high and low-frequency amplification.

STAND No. 9, also LOGGIA No. 72.—THE BRITISH L.M. ERICSSON MANFG. CO., LTD., International Buildings, 67-73, Kingsway, London, W.C.2.

The range of apparatus exhibited includes crystal receiving sets, one, two, three and four valve sets in various styles of cabinet work, and in some instances with self-contained batteries, potentiometers, single and dual filament resistances, low-frequency transformers, variable condensers, wave-traps, switches, plugs and jacks, microphone transmitters, head telephones and loud-speakers.

STAND No. 10.—AUTO SUNDRIES, LTD., 10a, Lower Grosvenor Place, London, S.W.

Radiosun Square Law Condenser.—Operated through a 20 to 1 reduction gear. End plates of Bakelite with coil spring contact and moving plate.

Radiosun Cam Switch.—Is designed to eliminate hand capacity and high-frequency losses. By simply slotting the cam any of 191 different circuit changes can be effected.

Radiosun Rheostat.—Consists of two interchangeable resistance units for use with either bright or dull emitter filament valves.

Radiosun Loud-speaker.—Possesses several novel constructional features, and in particular the form of the cavity which is immediately above the diaphragm. Finished with polished mahogany or crystallised black flare.

STANDS Nos. 11 and 12, also LOGGIA Nos. 74 & 75.—BURNDIPT WIRELESS, LTD., Aldine House, Bedford Street, Strand, London, W.C.2.

Ethophone I.—Two models are shown having a tuning range from 250 to 2,000 metres and fitted with micrometer crystal detector. Tuning is effected by means of self-contained inductances. The De Luxe model is of an attractive and distinctive design.

Ethophone Duplex.—A two-valve receiver with detector and note amplifying valves and fitted with plug in coils for a tuning range of 300-500 metres.

Ethophone Triplex.—Consists of the Duplex model fitted with a Uniplex amplifier mounted on a special mahogany plinth.

Ethophone III.—The wavelength range of 200 to 2,000 metres is controlled by a single switch which also operates the lighting of the valve. The tuning controls are fitted with the new Burndipt super-vernier dials. The receiving range is given as 50 to 60 miles from a main station and about 200 miles from Daventry.

Ethophone V.—Built as an open fronted cabinet with simple controls consisting of two tuning condensers and geared reaction. A special arrangement is used to minimise interference.

The Ethodyne.—An improved form of superheterodyne receiver employing seven valves. Simple to operate and fitted with vernier dials having a reduction gear of 7 to 1. Separate frame aerials are employed for long and short wave reception. The instrument is guaranteed to receive all British Broadcasting stations in any part of the country provided it is not operated in a steel-framed building.

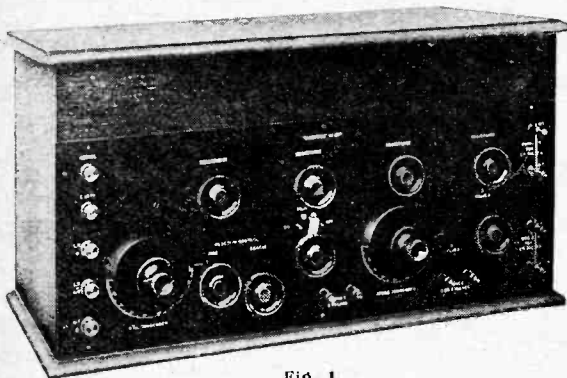

Fig. 1.

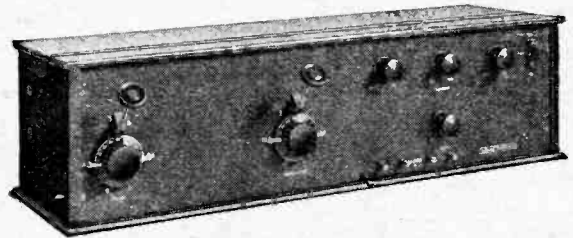

Fig. 2.

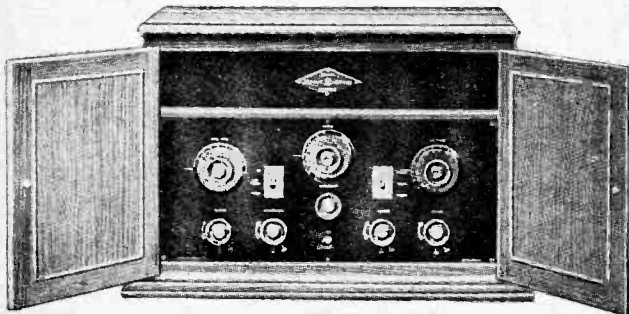

Fig. 3.

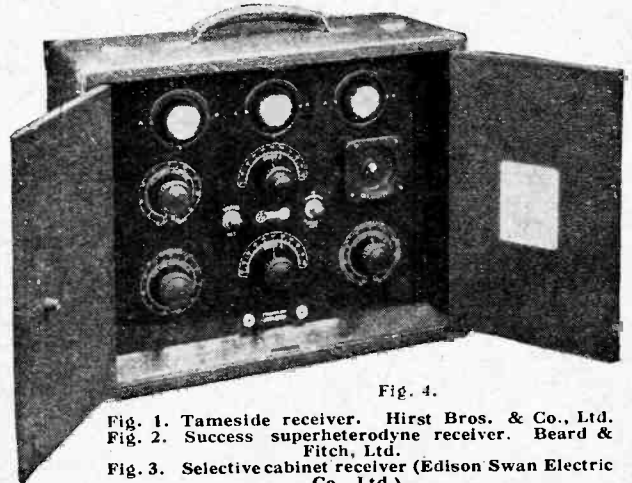

Fig. 4.

Fig. 1. Tameside receiver. Hirst Bros. & Co., Ltd.
Fig. 2. Success superheterodyne receiver. Beard & Fitch, Ltd.
Fig. 3. Selective cabinet receiver (Edison Swan Electric Co., Ltd.).
Fig. 4. B.T.H. Three valve portable superheterodyne receiver.

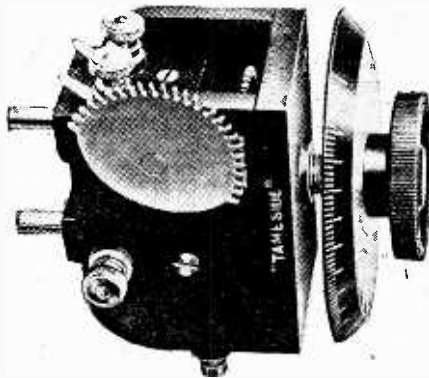

Fig. 1.

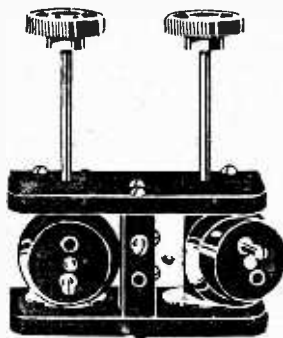

Fig. 2.

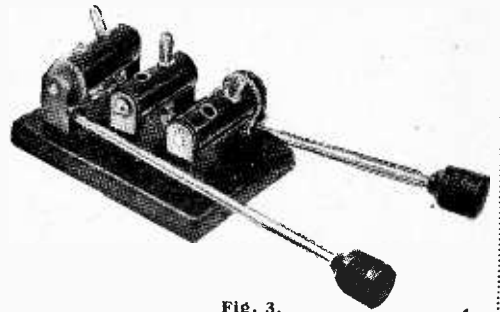

Fig. 3.

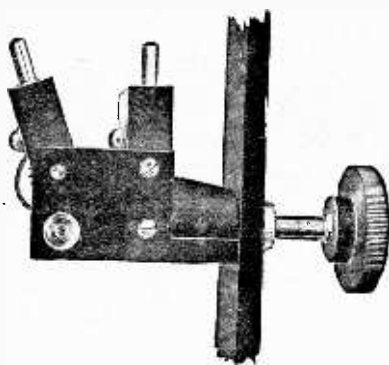

Fig. 4.



Fig. 5.

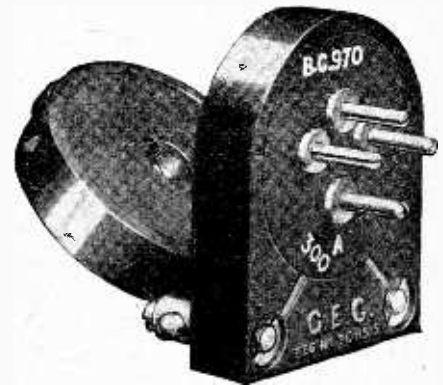

Fig. 6.

Fig. 1. Tameside two-coil holder. Hirst Bros. & Co., Ltd. Fig. 2. Polar reversible three-coil holder. Radio Communication Co., Ltd. Fig. 3. G.E.C. geared coil holder. Fig. 4. L. & P. coil holder. London & Provincial Radio Co. Fig. 5. R.I. tuning inductance. Fig. 6. G.E.C. anode reactance unit.

Ethophone Short Wave Receiver.—The receiving range is from 32 to 110 metres, and for easy manipulation is fitted with super-vernier dials. Two valves are used as detector and low-frequency amplifier, and with the addition of an extra amplifier the reception of the American station KDKA at good loud-speaker strength may be expected.

Other instruments include a tuner, a receiver with two high-frequency amplifying stages for a minimum wavelength of 80 metres, one and two-valve power amplifiers, wavemeter and wavemeter-rejector.

Burndept Auto-Broadcast System.—By means of this apparatus broadcast reception is controlled as easily as turning on an electric light. Operating current for the relays is supplied from the filament heating battery, and the control unit is fitted with an indicator knob. A thin three-wire lead covered cable is run to the points where it is desired to listen in. Local switches are operated without disturbing other listening points, and the last to be switched off disconnects the batteries.

Components and Sundries.—Burndept tuning coils now cover wavelengths down to 20 metres, and an additional series, numbered 3, 5, 7, 15 and 20 have been added to the range. Precision condensers are now available in two models, the normal and corrected square law type, with bearings that can be adjusted to give any desired amount of friction. The Burndept Super-vernier dial is fitted with a novel friction-driven, epicyclic gear concealed within a handsome 3½ in. dial with an engraved silver scale, 0 to 180 degrees. All moving parts are "floating" and self-compensating for wear.

Ethovox loud-speakers are shown in a wide range of attractive styles to suit various requirements. The Balkite battery charger is a full wave rectifier operating on an electrolytic principle for battery charging from A.C. mains.

Burndept Valves.—A special factory has recently been equipped for valve manufacture, and the reader is referred to

valve data published by the manufacturers concerning the properties of the complete range of valves now marketed.

STAND No. 13.—F. E. WOOTTEN, LTD., Midland Lighting Works, Aston Road, Birmingham.

STAND No. 14.—THE BOWYER-LOWE CO., LTD., Radio Works, Letchworth, Herts.

A very interesting range of apparatus which will appeal not only to the broadcast listener, but to the home experimenter can be inspected. It includes 7- and 8-valve superheterodyne receivers, superheterodyne kits, a new frame aerial, the new "four square" condenser, antiphonic valve holders, a new precision buzzer for use in wavemeters, square law and neutrodyne condensers, high-frequency and superheterodyne transformers, oscillator couplers for superheterodyne sets, variometers, coil holders and coil formers, switches, ebonite panels, an audibility meter, wave traps, and various 2-, 3- and 4-valve receivers.

STAND No. 15.—BRITISH EBONITE CO., LTD., Nightingale Road, Hanwell, London, W.7.

In addition to ebonite sheet, tube and rod in various cross sections, a number of mouldings such as knobs and dials for wireless purposes are of special interest.

STAND No. 16, also GALLERY STANDS Nos. 22 & 23.—MULLARD RADIO VALVE CO., LTD., Nightingale Works, Nightingale Lane, Balham, London, S.W.12.

Every type of valve can be viewed in the comprehensive collection of the products of this company. Among receiving valves over half a dozen types are displayed specially designed to suit the conditions of the many receiving circuit systems. A new valve of special interest recently introduced is the



Fig. 1.



Fig. 2.



Fig. 3.



Fig. 4.



Fig. 5.

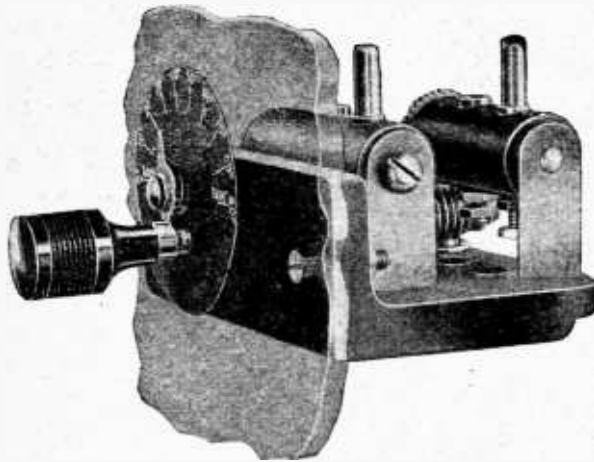

Fig. 6.

Fig. 1. Mansbridge variometer. Dubilier Condenser Co. (1925) Ltd. Figs. 2 & 3. Burndept plug-in tuning inductances. Fig. 4. Filter for superheterodyne receiver. L. McMichael Ltd. Fig. 5. R.I. oscillator coupler. Fig. 6. G.E.C. geared two-coil holder.

P.M.4, working with a filament current of 0.1 amp. at 3.5 to 4 volts, and is therefore a dull emitter with an extremely high emissivity. The low temperature at which this filament is operated eliminates the microphonic noises usually obtained when using the dull emitter valve, and therefore marks an important advance. The range of transmitting valves has been extended and includes a 5-watt valve for the amateur, up to the 30 Kw. valve for use in high power stations. The large valves are enclosed in silica, a form of construction which is a speciality of the Mullard Radio Valve Co. A high power metal-glass valve is also shown, rated at 30 Kw. Twelve types of rectifier valves in glass, silica and metal-glass are available. A new component of interest is the Mullard anode resistance, which is entirely wire wound and can be relied upon to be absolutely constant under conditions of reasonable use.

**STANDS Nos. 17, 18 & 19, also LOGGIA No. 42, and GAL-
LERY STANDS Nos. 13 & 14.—GENERAL ELECTRIC
CO., LTD., Magnet House, Kingsway, London, W.C.2.**

Receiving Sets.—Several important new G.E.C. productions are exhibited for the first time, covering the requirements of every type of listener and range from crystal sets to eight-valve supersonic heterodynes. The new Junior crystal set is a compact instrument with nickel-plated fittings on a polished mahogany panel. It is tuned by means of a fixed inductance coil and variable condenser, and covers a normal wavelength range of 300 to 500 metres with an extension to longer wavelengths by means of additional coils. The four-valve table model is a good standard instrument made with reliable components and wired to a straight circuit consisting of one high-frequency amplifier, valve detector, and two low-frequency valves. A novel feature is the eight-contact switch for controlling loud-speaker volume. Another type of four-valve instrument is complete with self-contained loud-speaker and high and low tension batteries. The latest addition to the Ethophone series is a supersonic heterodyne set. Two types are available, having a receiving range from 200 to 2,000 metres.

Accessories and Components.—This section caters for every need of the wireless experimenter and constructor. The new low loss slow motion variable condenser is of the square law type with a minimum capacity of approximately $\frac{1}{16}$ th of the maximum capacity. The rotary plates are connected with a frame to eliminate body capacity, and all metal parts are of brass. The reduction gear gives a micrometer adjustment either backwards or forwards without backlash with a smooth movement obtained by using non-slipping friction surfaces instead of cut gears. In the range of coil holders a back-of-panel type is an introduction which conforms to modern practice in the construction of sets. The new anode reactance unit is a useful component provided with a four-pin mounting and consists of a tuned anode winding with reaction coupling. Simple control of reaction is obtained by the variation of the angle between hinged and fixed coils. Other apparatus includes the Gecophone wavemeter, the Gecophone grip terminal connectors, and various special types of aerial earthing switches.

Valves.—Some recent outstanding developments in valve design figure on the General Electric Co.'s stand. The extensive range of valves manufactured by this company is too well known for detailed reference to be given here, and visitors are referred to the descriptive pamphlets issued by the company.

**STAND No. 20.—NEUTRON, LTD., Silician House, South-
ampton Row, London, W.C.1.**
Manufacturers of the "Neutron" crystal.

**STANDS Nos. 21 & 21a.—J. J. EASTICK & SONS, 2, St.
Dunstan's Hill, London, E.C.3. RADIAX, LTD., 4,
Percy Street, London, W.1.**

The sets and components exhibited include crystal and valve receivers, low-loss tuning coils, variable condensers, small adjustable condensers, high-frequency transformers, tuned anode couplings, reaction units, components for superheterodyne sets, low-frequency transformers, loop aerial, earth tube, loud-speakers, and the Apex crystal.

N.A.R.M.A.T. Wireless Exhibition.—

**STAND No. 22.—THE EAGLE ENGINEERING CO., LTD.,
Eagle Works, Warwick.**

Crystal Receiving Sets.—Model 3a, a box type set with slider tuner covering a wave range of 300 to 500 metres, a socket being provided for loading for long wave reception. Model 4 has a tuning range from 300 to 500 metres and 1,200 to 2,000 metres, produced by means of a variable condenser. The detector is glass enclosed.

Valve Receiving Sets.—No. 1 is fitted with a two-wave coil holder and plug-in coils covering a wave range of 200 to 3,000 metres. It is a simple box type instrument, while model No. 5a consists of similar equipment mounted in a cabinet, in which the high and low tension batteries are fitted. Another type of set employs a single valve, and is enclosed in cabinet work of antique design. The No. 9 receiver is fitted with detector valve and single stage low frequency amplifier, with a tuning range of 200 to 2,000 metres, obtained by a totally enclosed tuner. Bright or dull emitter valves may be used. High frequency amplification is included in type No. 7, and an important feature is the provision of a loose coupled aerial circuit providing a degree of selectivity, which is essential when several broadcasting stations are operating in a limited area. The series No. 7 includes a four-valve model with loose coupled aerial circuit, while the last low-frequency amplifying stage is resistance coupled. The De Luxe Pedestal Cabinet four-valve model incorporates the loud-speaker and batteries.

Accessories and Components.—Single and two-stage low frequency amplifiers are available for use with the various sets. For the home constructor the "Chakophone" unit construction system has been introduced. The "Chakophone" range of components includes almost everything necessary for the construction of receiving sets, and includes plug-in tuning coils, coil holders, a novel tuner and reaction unit, various variable condensers, fixed condensers, potentiometers and filament resistances, low frequency transformers, crystal detectors and switches.

**STAND No. 23.—BEARD & FITCH, Ltd., 34, Aylesbury Street,
London, E.C.1.**

A full range of "Success" radio components can be examined and includes low-frequency transformers, the "Superforma" for use in superheterodyne receivers, the "No Loss" condenser, an attractive design in which hand capacity effects are eliminated, a tuner, a well-designed geared coil holder, neutrodyne condenser, an ingenious aerial-earthing switch, and audio-frequency chokes. Of special interest is the "Success" oscillator unit, which is a companion instrument to the "Superforma," and in conjunction with a tuning condenser of capacity 0.0005 mfd. has a range from 250 to 600 metres. The new Microtune knob and dial is a reduction geared control with a ratio of 20 to 1. Coil holders for mounting behind the instrument panel and primarily intended for use in portable receiver construction are shown and possess the merit of occupying very little space. The "Success" supersonic heterodyne is an attractive eight-valve instrument enclosed in a cabinet finished in Louis XIV. style.

**STAND No. 24.—S. SMITH & SONS (M.A.), LTD, 179-185,
Great Portland Street, London, W.1.**

M.L. Components, High Tension Generators, etc.—Low-frequency transformer made in ratios of 1 to 2.6, 1 to 4, and 1 to 6. Telephone transformer with a ratio of 10 to 1; anode converter for high tension supply, type "B" with an input of 6 volts and giving 120 volts, type "C" 12 to 300 volts, and type "D" 12 to 500 volts; switch boxes for use with type "B" and "C" for obtaining two different H.T. voltages when required; composite types of anode converter and voltage box for obtaining two voltage outputs, both of which are variable, the type "Bx" giving 60 and 120 volts from an input of 6 volts, and type "Cx" outputs of 60 and 300 volts from 6 volts. Another special form of anode converter has been specially designed for use with three or more resistance capacity coupled amplifiers, type "By" 6 volts to 120 volts, and type "Cy" 12 volts to



Fig. 1.

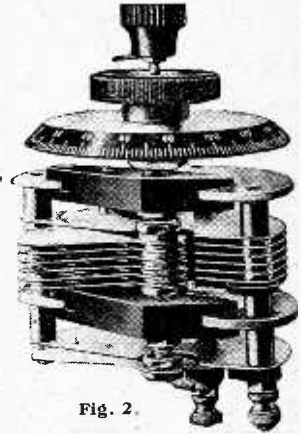

Fig. 2.

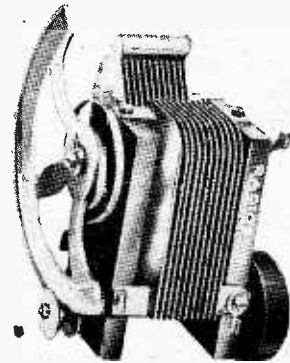

Fig. 3.

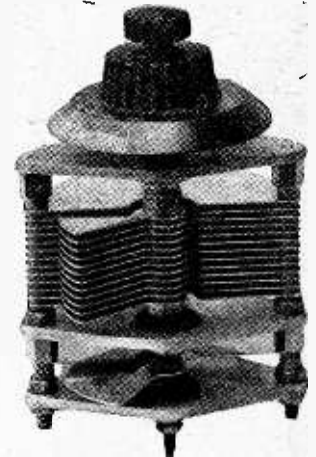

Fig. 4.

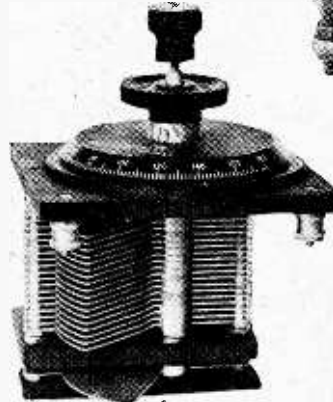

Fig. 5.



Fig. 6.

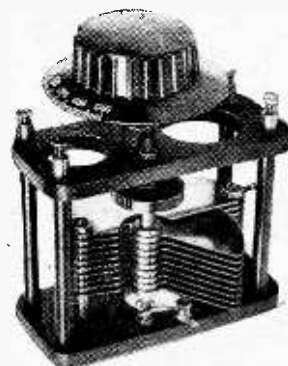

Fig. 7.

VARIABLE CONDENSERS.
Fig. 1. Dubilier double Vanicon with vernier. Fig. 2. Hirst Bros. & Co., Ltd. Fig. 3. Auto Sundries Ltd. Fig. 4. B.T.H. Fig. 5. Vanicon square law with vernier. Fig. 6. Burndep. Fig. 7. Success condenser. Beard & Fitch Ltd.

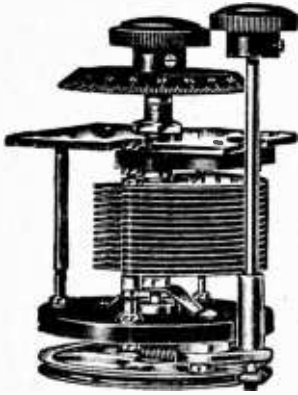

Fig. 1.

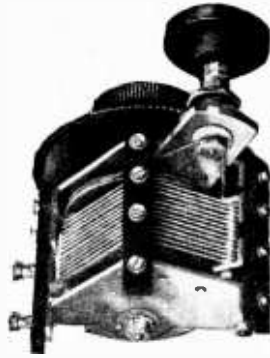

Fig. 2.



Fig. 4.

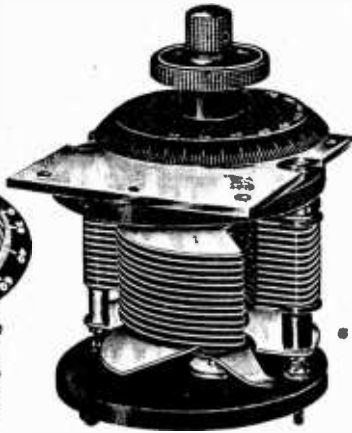

Fig. 3.



Fig. 6.



Fig. 5.

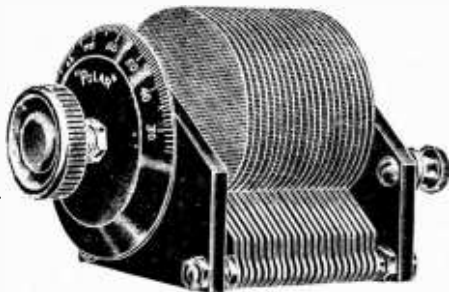

Fig. 7.

VARIABLE CONDENSERS.

Fig. 1. Geared R.I. condenser. Fig. 2. Cosmos "Slow Motion" condenser. Metro-Vick Supplies, Ltd. Fig. 3. R.I. condenser with vernier. Fig. 4. The Autoveyors Bridge condenser. Figs. 5 & 6. Polar micrometer condensers. Fig. 7. Polar variable condenser

300 volts. Small high tension generators are now manufactured fitted with an extended spindle suitable for pulleys or other forms of coupling and capable of delivering 40 milliamperes at 500 volts. An entirely new component is the resistance capacity auto-transformer coupling unit which consists of resistance and capacity connected in the usual way for intervalve coupling and combined with an intervalve transformer, the whole being formed into one unit having four terminals. A comprehensive range of the moulded materials manufactured by this company is exhibited.

STAND No. 25.—A. C. COSSOR, LTD., Aberdeen Works, Aberdeen Lane, Highbury, London, N.5.

Specially designed valves are now available for high and low frequency amplification, detection and power amplification. The electrodes of these valves follow the now well-known form with grid and plate of parabola section and arched filament. The valve sockets are made in red and black for identification purposes and constructed so that when fitted to the valve the added interelectrode capacity is negligible. A new valve being shown for the first time is the P.4.

STAND No. 26.—THE EDISON SWAN ELECTRIC CO., LTD., 123-125, Queen Victoria Street, London, E.C.4.

Two-valve Receiver.—The circuit consists of a detector valve with reaction and note magnifier, and is therefore capable of operating a loud-speaker from a local station and giving an extensive receiving range with head telephones. The set is of the circular pattern in moulded insulating material with valves mounted close together on a centre raised pillar, which carries the low-frequency transformer. Tuning is effected by means of a variable condenser, and a dual filament control is provided to suit either bright or dull-emitter valves. Tuning coils are of the plug-in type.

Ediswan Long Range Radiophone.—A four-valve set employing a reflex circuit and finished in a variety of styles in Chinese lacquer.

Components.—The range includes high tension accumulators and dry high tension batteries, dry batteries for dull emitter valves, two types of Ediswan loud-speakers, the "Televox" and "Dulcivox," and head telephone receivers.

Ediswan Valves.—It is interesting to note that many new additions to the well-known series of receiving valves have been recently added. The range is very extensive and reference should be made to the company's pamphlets for technical data.

STAND No. 27.—PELL, CAHILL & CO., LTD., 64, Newman Street, London, W.1.

Pelican Receiving Sets.—These receiving sets are designed to be entirely self-contained including frame aerial, batteries, and loud-speaker. The four-valve set is a standard model with a tuning range of 300 to 500 metres and 1,000 to 1,800 metres, and is fitted with internal tuning coils controlled by means of a two-position switch. Tuning is effected by means of a single dial, which operates through a reduction gear of 12 to 1, which is a very necessary feature owing to the sharp tuning which is invariably possessed by frame aerial sets. The enclosed loud-speaker is of reliable and well known manufacture, and the entire outfit is carried in a rose polished mahogany case.

The Pelican Uni-vernier.—Mechanism is contained beneath the dial whereby the rotation speed of the knob is twelve times that of the shaft. It is easily fitted to existing component instruments. The knob and dial are well finished in moulded Ebonium.

STAND No. 28, also LOGGIA No. 50.—DUBILIER CONDENSER CO. (1925), LTD., Ducon Works, Victoria Road, North Acton, London, W.3.

Small Fixed Capacity Condensers.—The range is complete and comprehensive and the well-known fixed capacity mica dielectric condensers include types 577, 600, 600a, 610, and 620. Type 577 is suitable for use in low power transmitting

N.A.R.M.A.T. Wireless Exhibition.—

apparatus and as a standard of capacity. Types 610 and 620 are replicas of types 600 and 600a, in so far as internal construction is concerned, but an improved type of insulating case has been introduced, while terminals and detachable grid leak clips are provided.

The Ducon.—An adaptor for utilising electric light wires of houses, flats, etc., as aerials. The instrument is suitable for use with all types of valve receivers.

Variable Condensers.—A display of "Vanicon" variable condensers includes square law type, double condensers for tuning two high-frequency circuits, and the "Duwatcon" series parallel condenser.

Resistances.—Suitable for use in anode circuits of valve receiving apparatus. An attachment for use in conjunction with type 600 condensers enables the grid leak to be connected in series.

Switches.—The six-point double pole double throw "Mini-cap" anti-capacity switch is suitable for use in receiving apparatus for bringing about series parallel connection, reversing coil connections, and for throwing in and out of circuit high and low-frequency amplifying stages. Well finished and nickel-plated.

The "Dubrescon" Valve Protector.—A device for protecting the filaments of valves against possible burn out due to accidental short circuit or incorrect connection of the L.T. and H.T. supply. This instrument is not a fuse, but a current limiting device, and is therefore permanent and does not require renewal.

Mansbridge Variometer.—A compact and efficient variometer constructed with "D" shaped coils suitable for tuning to broadcast wavelengths and up to approximately 1,800 metres by the addition of a small fixed condenser.

Mansbridge Condensers.—Genuine Mansbridge condensers, manufactured by the Mansbridge Condenser Co., Ltd., London, the Dubilier Condenser Co. being sole concessionaires. These condensers are totally enclosed in neat metal boxes filled with compound and are fitted with terminals.

Various types of transmitting condensers for use in high-power wireless stations and condensers for use as laboratory standards and other purposes are also exhibited.

STANDS Nos. 29, 30, 31, 32.—STERLING TELEPHONE & ELECTRIC CO., LTD., 210-212, Tottenham Court Road, London, W.1. THE MARCONIPHONE CO., LTD., Marconi House, Strand, London, W.C.

Marcomphone Type 21 Receiver.—A two-valve model of entirely new design comprising detector valve and low-frequency amplifier. The wave range, 300 to 3,000 metres, is produced by means of interchangeable coils and can be extended by means of additional coils. A switch for breaking both high and low tension supply is fitted.

Marcomphone Type 31 Receiver.—This is another instrument being shown for the first time, incorporating the essential features of the two-valve model but with an additional stage of low-frequency amplification. The design aims at excellence of quality of reproduction and ease of manipulation rather than extreme selectivity.

Marconiphone Type 41 Receiver.—The introduction of a high-frequency amplifier in this four-valve set provides extra range and selectivity without making the instrument unduly difficult to operate. Selectivity is further improved by incorporating a new type of rejector which operates on wavelengths up to 1,800 metres.

Marcomiphone Type 81 Receiver.—An instrument primarily designed for the greatest possible range, while maintaining quality and selectivity, together with extreme ease of manipulation. It consists of five high-frequency amplifying stages carefully balanced to maintain the circuit stable under all conditions, followed by a valve detector and two low-frequency amplifiers. No provision is made for reaction, which the manufacturers consider unnecessary and undesirable in this set. The instrument is contained in a lock-up cabinet complete with high tension batteries, and can be supplied if required for deriving high tension current from the public supply mains. Tuning circuits, excepting the aerial, are calibrated directly in wavelengths. It is interesting to note that this instrument will

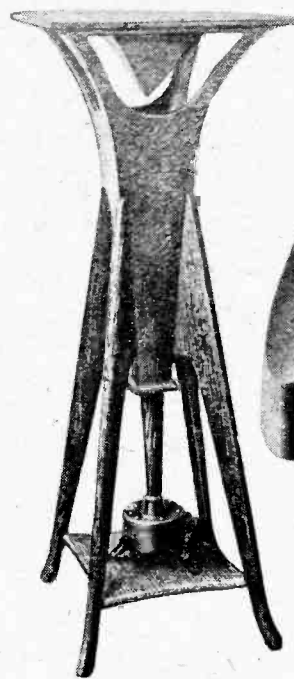

Fig. 1.



Fig. 2.

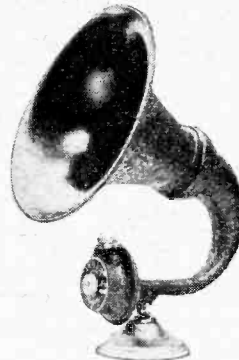

Fig. 3.

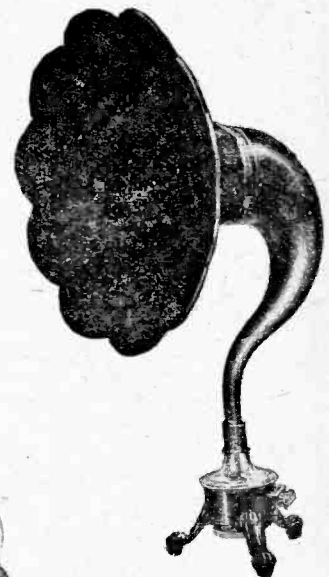

Fig. 4.

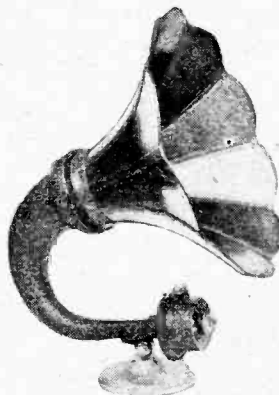

Fig. 5.

LOUD-SPEAKERS.

Fig. 1. Hirst Bros. & Co., Ltd.
Fig. 2. The Mellovox. Sterling Telephone & Electric Co., Ltd.
Fig. 3. Amplion Type A.R.III.
Fig. 4. Ethovox. Burndpeit Wireless Ltd. Fig. 5. Amplion Type A.R.19. Alfred Graham & Co.

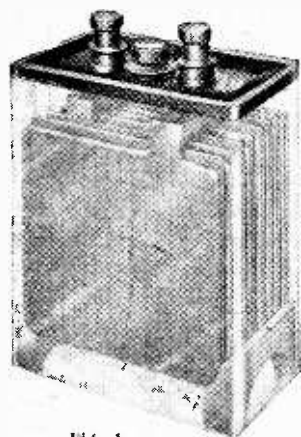

Fig. 1.

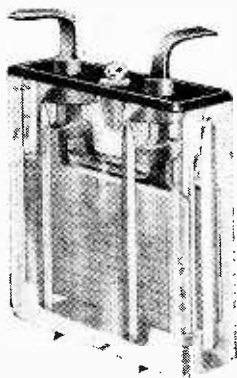

Fig. 2.

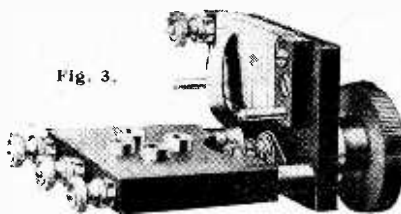

Fig. 3.



Fig. 4.

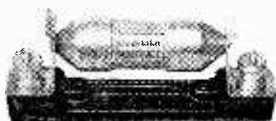

Fig. 5.



Fig. 6.

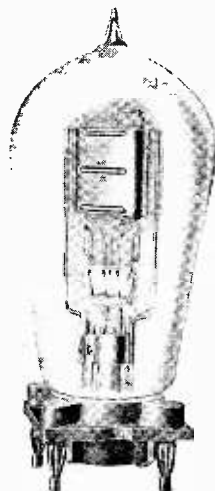

Fig. 7.

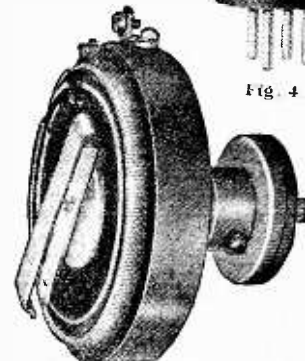

Fig. 8.

Figs. 1 & 2. Hart Accumulator Types M.E.G. and P.L.R.G. Fig. 3. Filament resistance and valve holder unit, Hirst Bros. & Co., Ltd. Fig. 4. Mullard valve Type PM4. Fig. 5. Dubilier anode resistance. Fig. 6. Mullard anode resistance. Fig. 7. M.O. diode-emitter transmitting valve, Type D.E.T.1. Fig. 8. Ericsson filament resistance.

separate Manchester from London without a rejector at a distance of four miles from London.

Marconiphone Type V1 Receiver.—A single-valve set with a range of 300 to 3,000 metres produced by an ingenious method of interchangeable range blocks. Reaction is controlled by an unusual method, making use of a variable resistance which possesses the merit that wavelength changes are not brought about when changing the amount of reaction.

Marconiphone Type V2 Receiver.—This well-known instrument makes use of two valves incorporated in a reflex circuit. It is capable of long range reception, and is tunable between 185 and 3,000 metres by a simple method of interchangeable range blocks.

Marconiphone Type V3a Receiver.—Similar in circuit arrangement to the V2, with the addition of one stage of low-frequency amplification, the instrument is a long range receiver providing easy operation.

Marconiphone Type VB4 Receiver.—An additional low-frequency amplifying stage is included as compared with the V3a employing "Ideal" interval transformers. A rejector circuit eliminates local interference, and a tuning range of 300-500 metres by the simple adjustment of two switches. Two, three, or four valves can be used as desired.

Marconiphone Amplifiers.—Types A2 and B2 are two-stage low-frequency amplifiers and type H3 is a tuned high-frequency amplifier which may be employed with most standard types of circuits for improving range and selectivity.

Other apparatus includes a rejector and buzzer wavemeter. Components include the "Ideal" transformer, the Junior "Ideal" transformer, a new component with a 3 to 1 ratio, and various range blocks and regenerator units for use with the V2 and V3a receiving sets.

Sterling Crystal Receiver.—Variometer tuning is employed with a range of 300 to 500 metres. The crystal detector is a semi-automatic pattern which renders the adjustment extremely simple. A switch is provided for tuning to 1,600 metres.

"Anodion" Receiving Sets.—The series is characterised by the sloping desk type cabinet, upon which rests the ebonite panel carrying the various components. The one-valve receiver has a tuning range of 175 to 925 metres, and can be extended

by means of plug-in units to 7,600 metres. There are two two-valve models, one a high-frequency amplifier with valve detector, and the other, intended for local loud-speaker reception, consists of an oscillating detector valve and low-frequency amplifier. Similarly, in the three-valve models is a long range receiver consisting of a high-frequency amplifier, valve detector, and note magnifier, and also an instrument connected so that the first valve detects and is followed by two low-frequency stages. The "Anodion" four-valve receiver is a long-range set for loud-speaker reception. The normal tuning range is 300 to 500 metres, but as in the other models tuning ranges are also obtainable between 40 and 5,000 metres, a feature only to be found in the Sterling receivers.

Sterling Table Cabinet Type Receivers.—The sets are of a vertical panel type enclosed in attractive upright cabinets fitted with double doors. The valves are mounted behind the panel and in three of the models are visible through the valve windows. The series includes a high-frequency amplifier with detector valve, a detector valve with two low-frequency amplifiers, and a four-valve set with high-frequency amplifier and two low-frequency valves. The four-valve floor cabinet type consists of a Sterling four-valve receiver combined with the "Primax" loud-speaker in a particularly handsome walnut cabinet. The tuning range is 40 to 5,000 metres, and for very short waves aerial coupling units are used in the aerial circuit in place of the usual inductances.

Sterling Telephone Receivers.—Three types are exhibited, the "Lilliput," "Lightweight," and "Super Quality," as well as a single earpiece with handle mounting and a "Super Quality" double set hand telephone.

Sterling Loud-speakers.—The range includes the "Dinkie," a small instrument suitable for a room of average dimensions; the "Baby," a slightly larger model; the "Audivox," and the "Mellovox." The last mentioned is a hornless model of entirely new design. The conical diaphragm, which is not pleated, is beautifully finished, carrying floral decorations in black and gold. The "Primex" is the well-known Sterling hornless loud-speaker with pleated diaphragm.

Power Amplifiers.—There are two models with totally enclosed valves and fitted with key switch, rendering the second amplifying stage optional.

N.A.R.M.A.T. Wireless Exhibition.—

Sterling Components.—The range of components is very complete and includes the Sterling variometer for tuning from 250 to 2,725 metres, reaction units producing an aerial circuit tuning range of 40 to 5,000 metres, variable condensers for panel mounting or enclosed type, geared, double and triple condensers, Sterling geared coil holders, fixed capacity condensers, high and low-frequency transformers, filament resistances with interchangeable resistance spools, non-microphonic valve holders, anti-capacity and multi-contact switches, grid leaks, telephone cords, terminals, and tags.

STAND No. 33, also LOGGIA No. 58.—C. A. VANDERVELL & CO., LTD., Acton, London, W.3.

Crystal Detector.—Designed to give maximum rate of adjustment together with accessibility and permits of nearly the whole of the crystal area being explored. The contact point is capable of a very fine regulation of pressure, and the whole of the movement is mounted on a moulded circular base, and enclosed in a glass dome.

C.A.V. Tuning Coils.—Wound with No. 22 S.W.G. bare copper wire, air spaced on special formers, and protected by a robust casing. The mounting block carrying a plug and socket is cut away to reduce the capacity between the metal parts. A set of four interchangeable coils have a tuning range of from 250 to 1,650 metres.

Intermediate Frequency Transformer.—For use in super-heterodyne receivers, wound with No. 44 S.W.G. silk covered wire on a slotted ebonite former, and fitted with soldering tags and terminals. Optimum wavelength 10,000 metres.

Multiple Fixed Condenser.—By combining several condensers in one case with convenient tapping points a wide range of capacities is obtainable. Two types are manufactured with capacity values of from 0.001 to 0.015 and 0.0001 to 0.0015 mfd.

"All Purpose" Low Frequency Transformer.—The windings are sectionalised, the primary being wound with No. 42 S.W.G. wire, and the secondary with No. 44 S.W.G. wire. Each transformer is individually tested on broadcasting against a standard, and is guaranteed to have an insulation resistance of at least 1,500 megohms. The winding ratio is 3 to 1. A higher grade transformer is the "De Luxe" model, obtainable in two ratios.

C.A.V. Valve Holder.—The valve sockets are constructed of helical springs supported by means of a cushion ring which prevents the transmission of vibration or shock to the valve. Intersocket capacity is kept as low as possible consistent with mechanical strength by providing slots between the metal parts.

Filament Rheostat.—The resistance unit is interchangeable, and the contact is perfectly silent both mechanically and electrically. Designed for one hole panel fixing.

C.A.V. Loud-Speakers.—The variety of types is extensive, and includes the "Standard" model, "Junior" model, the "Tom-Tit," finished in many different styles, a gramophone attachment, and a hornless model.

C.A.V. Accumulators.—Many new and useful types of batteries are available. The H.T.3 is a 60-volt battery of 1 ampere hour capacity for high tension supply. The H.T.2 is a 60-volt 2 ampere hour capacity battery, normally capable of giving six months' service without recharging. Combined H.T. and L.T. Battery sets are also exhibited.

STAND No. 34.—FALK, STADELMANN & CO., LTD., Efesca Electrical Works, 83-87, Farringdon Road, London, E.C.1.

Efescaphone Wireless Receiving Sets.—The full range includes all types of sets commonly used for broadcast reception. They are the "Benbow" and "Benbow Junior" crystal sets, the "St. Vincent" crystal 1 and 2-valve sets, the "Anson" crystal and 1 and 2-valve sets, the "Rodney" 3-valve set, and the "Hood" and "Nelson Grand" 3 and 4-valve models. The 4-valve "Nelson Grand" receiver is tunable from 150 to 4,000 metres, the various ranges being obtained by a switch, no plug-in coil or external tuning accessories being required.

Efesca Components.—The "Efesca" geared condenser operates through a 12 to 1 reduction gear. Another novel instrument is the "Efesca" series parallel condenser, which is an entirely new departure and embodies an automatic switching device whereby during the first 180 degrees of rotation of the moving vanes the condenser is in series with the aerial coil, and during the second 180 degrees it is connected in parallel. The "Efesca" regenerative aerial tuner is a specially designed form of tapped aerial coil incorporating aerial reaction, and is a self-contained unit with one hole fixing. Among filament resistances is the "Vernistat," which

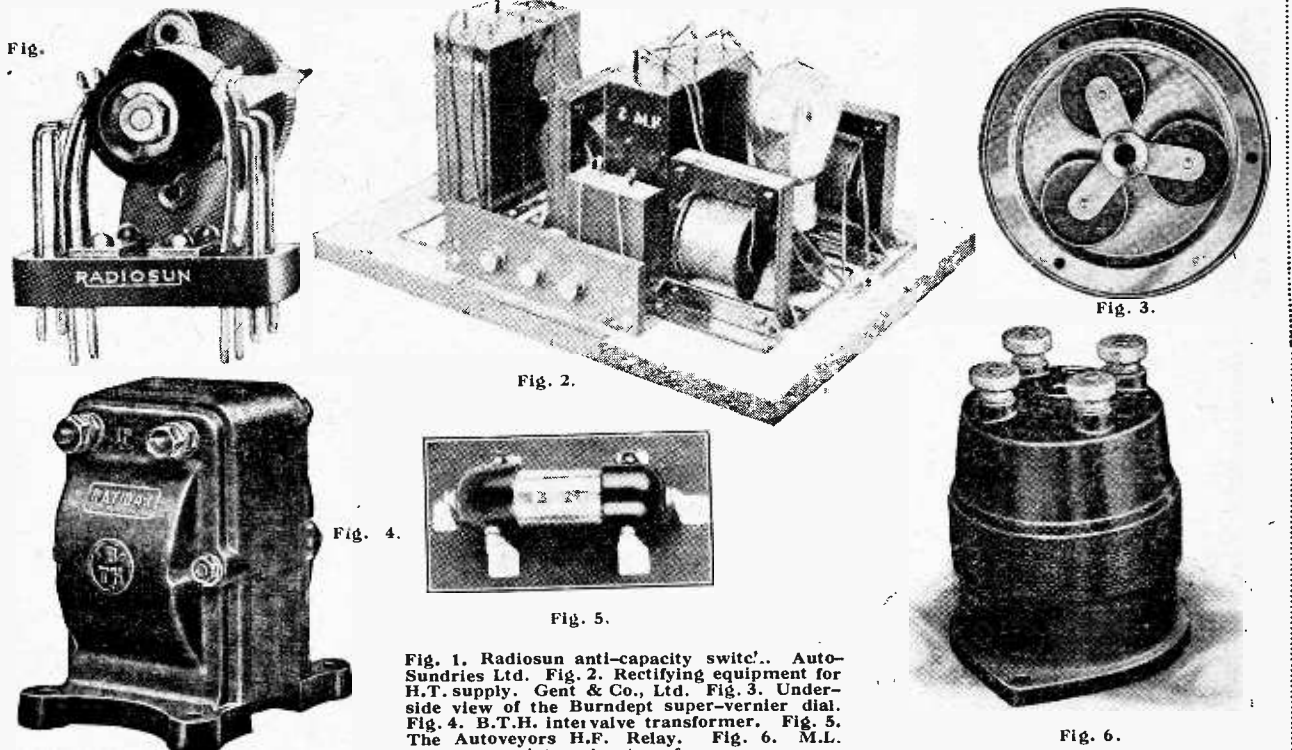

Fig. 1. Radiosun anti-capacity switch. Auto-Sundries Ltd. Fig. 2. Rectifying equipment for H.T. supply. Gent & Co., Ltd. Fig. 3. Under-side view of the Burdept super-vernier dial. Fig. 4. B.T.H. intervalve transformer. Fig. 5. The Autoveyos H.F. Relay. Fig. 6. M.L. intervalve transformer

N.A.R.M.A.T. Wireless Exhibition.—

is wire wound and obtainable for either bright or dull emitter valves, and the "Carbostat," in which "packing" is overcome by a method of construction whereby powdered granules and powdered graphite are mounted in sections separated by compressed springs. The "Efesca" dual rheostat is a new production and suitable for the control of both bright and dull emitter valves. An interesting change-over switch of the anti-capacity type is shown and consists of two small ebonite mounted connecting plates moving across the contacts mounted edge to edge. It is a 6-point two-position switch resembling in external appearance an ordinary Dewar key, and in either brass or nickel finish. "Efesca" products also include head telephones and the "Puravox" miniature loud speaker, as well as a high tension battery constructed of large type cells to withstand prolonged use with multi-valve sets.

STAND No. 35.—CLIMAX PATENTS, LTD., 182, Church Street, Kensington, London, W.8.

Climax Receiving Sets.—All tuning coils are contained inside the cabinet, anti-phonic valve holders are fitted, and an attractive finish is obtained by good cabinet work and nickel-plated fittings. Tuning is effected by a single knob controlling a variometer and to which reaction can be applied by an independent adjustment. Each valve has a separate filament control, and the resistance is constructed to permit of the use of either dull or bright emitter valves. The normal wavelength range is 300 to 500 metres, though the tuning and reaction coils, which are readily accessible through a door provided in the cabinet, can be removed as one unit and replaced in a few seconds by a tuner for reception on 1,600 metres and other wavelengths as required. The entire range of Climax sets includes a crystal receiver, a single-valve portable, for which an amplifier unit is supplied, Climax popular two, three and four-valve sets, also two, three and four-valve sets in De Luxe models, a super-heterodyne receiver and a wavetrap.

STAND No. 36.—RADIO INSTRUMENTS, LTD., 12, Hyde Street, New Oxford Street, London, W.C.1.

New R.I. Crystal Sets.—In addition to the comparatively cheap form of simple crystal receiving sets, two new types of instruments fitted with low frequency valve amplifying equipment are now available. The several different types are each fitted with the well-known R.I. permanent mineral detector. Both crystal detector and amplifying valves are contained in the back of the instrument and are accessible by means of a hinged door. The terminals also are at the rear of the cabinet, so that only necessary tuning controls are visible when the set is in use. A switch is provided for extending the wavelength to 1,600 metres. Dual rheostats for bright or dull emitter valves are fitted. The instruments are mounted in polished mahogany cabinets with folding doors, so that the whole apparatus may be closed to protect it from dust.

Valve Receiving Sets.—These are made up in three models and enclosed in cabinets very similar to the crystal amplifying unit. One type comprises a valve detector in conjunction with a single stage note magnifier with a tuning range of 300 to 4,000 metres. Another type is fitted with a two-stage amplifier. A pedestal container or base is provided for the use of dry batteries. Fitted in a larger and more elaborate cabinet is a set embodying a high frequency amplifying stage, tuning from 300 to 4,000 metres.

Note Amplifiers.—Two patterns are available consisting of single and two-stage amplifiers. As in previous instruments, the terminals and access to the valves are at the back, with controls fitted on the panel at the front. Bright or dull emitter valves can be used, and special means have been taken in the circuit arrangement adopted to prevent distortion.

New R.I. Geared Condenser.—The method of gearing is new and is designed to prevent backlash. A small fibre pinion presses against a large grooved aluminium wheel, the friction between the two ensuring a positive movement. The gearing ratio is 11 to 1. The plates are of hard brass sheet, and the general construction of the condenser is such that it is absolutely rigid. A variable square law condenser with vernier vane is also available. Fixed and moving plates are of hard

brass sheet, and the condenser is mounted on a solid heavy brass plate which acts as a rigid frame for mounting the elements and also serves the purpose of a capacity screen.

The R.I. Duostat.—Designed for use with both bright and dull emitter valves. The resistance wire coils are wound on hard insulating cylinders of large diameter so that ample wire can be employed and a liberal surface provided to prevent heating. The component is well finished in dull black and fitted with one hole fixing carrying on the front of the panel a double range scale.

R.I. Superheterodyne Components.—The specially designed oscillation coupler is complete with its tuning variable condenser, whilst another somewhat less expensive unit is available for use with a separate tuning condenser. A filter unit is also manufactured for use on a wavelength of 6,000 metres. High frequency transformers for constructing an intermediate amplifier are supplied and tuned broadly to the same wavelength as the filter unit.

STAND No. 37, also LOGGIA No. 46.—A. J. STEVENS & CO. (1914), LTD., Walsall Street, Wolverhampton.

The latest productions of this company include, two, three, and four-valve receivers, in walnut cabinets, while the four-valve instrument is shown in various cabinets, including an exquisite Louis XV. Renaissance model. Switching is provided in the four-valve model, so that two, three, or four valves may be thrown in circuit.

The amplifying equipments include one and two-valve instruments. The Concert Amplifier is fitted with tone and volume controls and a provision is, of course, made for obtaining the correct grid bias adjustments. The range of A.J.S. components is very comprehensive and includes a low loss condenser of unusual and attractive design, fitted with anti-capacity shields, and in which the plates are shaped to give a negligible minimum capacity. A new type of A.J.S. fixed condenser has recently been introduced, obtainable in a complete range of capacity values and enclosed in a polished, moulded case of good finish. Accessories include the A.J.S. headphone, which is now put on the market for the first time. A new tubular steel telescopic mast is of particular interest. Two sizes are manufactured, measuring 35ft. and 50ft. when erected and 18ft. 3in. and 19ft. 6in. respectively nested for transit. No erecting gear is required, and the larger mast can be set up in less than twenty minutes. The masts are complete with base plates, angle iron ground pegs, guy wires fitted with strainers and insulators and aerial pulley.

STAND No. 38.—CHLORIDE ELECTRICAL STORAGE CO., LTD., 219/229, Shaftesbury Avenue, London, W.C.2.

A complete range of Exide accumulators suitable for wireless purposes is exhibited, including celluloid cased accumulators from 6 to 120 ampere hours actual capacity suitable for bright emitter valves, and the type HZ, of from 40 to 80 ampere hours capacity intended for use with dull emitter valves and capable of standing as long as six months without recharge. The DTG and DF cells are also constructed to stand up for six months without recharge, and are specially useful for the filament heating of the 0.06 type dull emitters. These cells are of 20 and 45 actual ampere hours capacity.

With the increased use of high tension accumulator batteries special attention is given to accumulators of this type. A new type of high tension accumulator, which can be left for a period as long as six months without recharge, is of unusual interest. The property to withstand the danger of sulphating for such a long period is an almost essential feature when an accumulator is used in place of a dry battery for I.T. supply. The battery is constructed in twelve cell units with a normal capacity of 5,000 milliampere hours and with a charging rate of 0.25 amperes. It is supplied in a dry charge condition and can be put into operation immediately after filling it with acid. The plates can be readily inspected and the acid level is plainly marked.

STAND No. 39.—A. W. GAMAGE, LTD., Holborn, London, E.C.1.

An entirely new accessory is the Gamage Remote Control Switch. The instrument is designed for the purpose of switch-

N.A.R.M.A.T. Wireless Exhibition.—

ing the receiving set on and off at points distant from the set where a loud-speaker is operated. Another product of this company is the "Gamage Rolls" portable set. The instrument is contained in a leather attaché case and is a three-valve receiver with switching for disconnecting one of the valves from circuit. The receiving range for loud-speaker reception is stated to be 15 to 20 miles. A very complete range of valve and crystal receiving equipments can be inspected and arrangements have now been made for the purchase of apparatus under a popular hire-purchase system.

STAND No. 40.—ALFRED GRAHAM & CO., St. Andrew's Works, Crofton Park, London, S.E.4.

Facilities are available for the demonstration under home conditions at the Amplion Suite, Kensington Palace Mansions, De Vere Gardens, which is within three minutes of the Albert Hall. The principal current types include the Dragonfly (AR.102), New Junior (AR.111), New Junior De Luxe (AR.114), Standard Dragon (AR.19), and Concert Dragon (AR.23). Various improvements have recently been introduced, and the various Amplion loud-speakers exhibited include some interesting developments in design.

LOGGIA No. 41, also LOGGIA No. 76.—AUTOVEYORS, LTD., 24, Victoria Street, Westminster, London, S.W.1.

Clix Plug Sockets.—The utility of these well-known connectors has been further extended by the introduction of several minor auxiliaries. The plug socket proper is now given a nickel-plated finish, whilst many of the coloured polished insulating rings have a translucent appearance. For panel mounting, a new type adapter is available for use instead of the standard plug socket, while another form of adapter is fitted with bushes for mounting in a wooden panel. The series connector, by means of which two plug sockets may be mounted end on end, is useful for connecting telephone and other leads in series. For making connection under the Clix locknut, Clix "Ringtags" are now supplied.

Radio Condit.—This new rigid connecting wire is a hollow copper tube, and is supplied in 24 in. lengths of a diameter equivalent to No. 16 S.W.G.

Spiral Vernier Condenser.—A flat metal plate and a spiral spring plate are separated by an insulating disc of mica. The rotation of the knob compresses the spiral spring against the flat metal plate, thus affording a gradual increase of capacity. This component is designed so that it can be mounted by means of two screws on the face of the instrument panel, or it may be mounted under the panel by means of a nut on the controlling spindle, which provides one-hole fixing.

Other products include the Bridge condenser, which is now operated from one compound knob, whilst modifications in design enable the condenser to be panel mounted in the ordinary one-hole fixing method. A new device recently introduced is the H.F. Relay, which is a form of valve in which the grid and anode are of spiral form with connections taken from both ends of the spirals and brought to connectors on the outside of a tubular bulb.

LOGGIA No. 42.—GENERAL ELECTRIC CO., LTD.—Refer to STANDS Nos. 17, 18, & 19.

LOGGIA No. 43.—TRADER PUBLISHING CO., LTD., 139-140, Fleet Street, London, E.C.4.

The Wireless Trader.—Published every Wednesday (incorporating "The Wireless and Allied Trades Review"). By subscription 8s. per annum post free (overseas 10s.). The leading trade journal of the wireless industry in Great Britain, devoted to the interests of dealers and manufacturers.

The Wireless Export Trader.—Published 1st of the month. Worldwide subscription 10s. per annum, including postage. For the radio dealer and importer of British goods for sale in every market of the world.

The Wireless Trader Year Book and Diary.—Published in December. Contains reliable and comprehensive trade buying

guide, list of factors arranged territorially, alphabetical list of proprietary names, directory of manufacturers and traders, broadcasting, technical and trade information, etc.

LOGGIA No. 44.—ILIFFE & SONS LTD., Dorset House, Tudor Street, London, E.C.4.

The Wireless World & Radio Review. Published every Wednesday. Editorial Offices: 139-140, Fleet Street, London, E.C.4.

LOGGIA No. 45.—ILIFFE & SONS LTD., Dorset House, Tudor Street, London, E.C.4.

Experimental Wireless & The Wireless Engineer.—A journal of radio research and progress. The official organ of the Radio Society of Great Britain. Published on the 1st of each month. Editorial Offices: 139-140, Fleet Street, London, E.C.4.

LOGGIA No. 46.—A. J. STEVENS & CO. (1914), LTD.—Refer to STAND No. 37.

LOGGIA No. 47.—THE BRITISH RADIO CORPORATION, LTD., Weybridge, Surrey.

The range of receiving sets is very complete and includes all classes of apparatus from a two-valve cabinet receiver to an attractive five-valve cabinet neutrodyne. A distinctive feature of these sets is that an ingenious wide range tuner is fitted which provides for continuous tuning from 200 to 2,000 metres without the need for the interchanging of inductance coils. This tuning equipment is supplied separately as a component for amateur use, and may take the place of a coil holder with its set of tuning coils. The "All Break" is another interesting component which is intended to take the place of the terminals of a receiver. Among the more elaborate sets is the Astra-phone IV, which is designed for long distance reception and has a tuning range of 200 to 3,000 metres. A unique feature is the fitting of a control for changing the circuit. The neutrodyne receiver is a five-valve cabinet set provided with a means of cutting out one valve when required. The receiver is supplied with a chart showing its calibration.

LOGGIA No. 48.—BERTRAM DAY & CO., LTD., 9 & 10, Charing Cross, London, S.W.1.

Advertising Agents.

LOGGIA No. 49.—PELL, CAHILL & CO., LTD.—Refer to STAND No. 27.

LOGGIA No. 50.—DUBILIER CONDENSER CO. (1925), LTD.—Refer to STAND No. 28.

LOGGIAS Nos. 51 & 52, also No. 73.—RADIO PRESS, LTD., Bush House, Strand, London, W.C.2.

LOGGIA No. 53.—HIRST BROS. & CO., LTD., Roscoe Street, Oldham.

Tameside New Model Receiving Sets.—The series includes one-, two-, three- and four-valve sets mounted on ebonite panels and housed in Jacobean style oak cabinets. All brasswork is given a nickel-plated finish. The circuits employed are quite "straight." The single-valve set, which is tuned by means of plug-in coils, is fitted with aerial reaction and vernier adjustment on both condenser and two-coil holder. Tuned anode high-frequency amplification is provided in the two-valve set, which is fitted with vernier controls and separate filament resistances for the valves. The three- and four-valve models have respectively one and two stages of low-frequency amplification added to the two-valve circuit. A switch is fitted to the four-valve instrument to enable it to be used as a two-, three- or four-valve set.

Tameside Components and Accessories.—An interesting component which has many applications in amateur constructional work is the two-way geared coil holder with one hole fixing for mounting behind the instrument panel. A dial with divided scale covers the positions between maximum and minimum

N.A.R.M.A.T. Wireless Exhibition.—

coupling so that the coil holder can be set to any predetermined position. Other components include a low loss square law condenser with single plate vernier and a combined rheostat and valve-holder with interchangeable resistance units. In the Thameside leading-in tube is incorporated an earthing switch, and substantial terminal-connections are arranged for the aerial and earth leads of the set.

LOGGIAS Nos. 54 & 55.—CASSELL & CO., LTD., Ludgate Hill, London, E.C.4.

LOGGIAS Nos. 56 & 57.—NATIONAL WIRELESS & ELECTRIC CO., 42, Gray's Inn Road, London, W.C.1.

Crystal Receivers.—Among the various models is a new low loss set fitted with a quick change-over switch for extending the wave range to 1,600 metres. No external loading coils are used, and the crystal detector is fitted with a micrometer control capable of providing a critical adjustment.

Valve Receivers.—All sets have a wavelength range of 300 to 3,000 metres obtained by totally enclosed tuning coils fitted with variable reaction. The sets are completely self-contained, the batteries being accommodated in the cabinets. These instruments are suitable for use with either bright- or dull-emitter valves. The ebonite panels are hand polished and all fittings nickel-plated, while the cabinets are fitted with glass doors, rendering the sets particularly attractive. Among the receiving equipments is a three-valve portable set, which is entirely self-contained in a mahogany cabinet 12in. x 12in. x 8½in., weighing 17lb.

Accessories include a compact single-stage low-frequency amplifier and loud-speakers in mahogany and oak of special design. Of the various components mention might be made of the National Super-Crystal Combination, the Precision Super-Crystal detector with micrometer action, National low-frequency inter-valve transformer, and the National tuner with variable reaction.

LOGGIA No. 58.—C. A. VANDERVELL & CO., LTD.—Refer to STAND No. 33.

LOGGIAS Nos. 59 & 60.—BRITISH THOMSON HOUSTON CO., LTD.—Refer to STAND No. 1.

LOGGIA No. 61.—ODHAMS PRESS, LTD., 93, Long Acre, London, W.C.2.

LOGGIAS Nos. 62 & 63.—HART ACCUMULATOR CO., LTD., Marshgate Lane, Stratford, London, E.15.

As specialists in storage battery manufacture, the whole of the exhibits consist of accumulators suitable for wireless work. The many different types form a very complete and comprehensive range, and reference should be made to the company's circulars for detailed descriptions. In addition to various batteries for high and low tension current supply, the introduction of accumulator grid batteries is of interest. Batteries for wireless work aboard ship and many batteries for general portable purposes are also shown.

LOGGIA No. 64.—COLONIAL TECHNICAL PRESS, LTD., 36, Southampton Street, Strand, London, W.C.2.

LOGGIAS Nos. 65 & 66.—GEORGE NEWNES, LTD., 8-11, Southampton Street, London, W.C.2.

LOGGIA No. 67.—RADIO COMMUNICATION CO., LTD.—Refer to STAND No. 5.

LOGGIA No. 68.—DUNLOP & CO., LTD., 1-2, Whitfield Street, London, E.C.2.

LOGGIA No. 69.—LONDON & PROVINCIAL RADIO CO., LTD., Colne Lane, Colne, Lancs.

Ellanpee Valve Unit.—Combines valve holder, filament rheostat, and valve window, and arranged for mounting behind the instrument panel by means of one-hole fixing bush. Wiring is simplified, as one side of the filament circuit is already connected, and terminals as well as soldering tags are provided. The valve holder is of the anti-capacity type, and insulation on the valve sockets prevents the valve filament from being burnt out by incorrectly inserting the pins of the valve. Wound to a

resistance up to 6.5 ohms for bright emitter valves, and 35 ohms for the dull emitter 0.06 type.

Ellanpee Coil Holder.—The two-coil holder is designed for one-hole fixing, operated by means of a worm and pinion, and a spring balances the weight of the moving coil in order to avoid backlash.

LOGGIA No. 70.—CABLE PRINTING AND PUBLISHING CO., LTD., 7/11, Theobald's Road, London, W.C.3.

LOGGIA No. 71.—KENMAC RADIO, LTD., 2a, Dalling Road, Hammersmith, London, W.6.

Manufacturers of receiving instruments and components.

LOGGIA No. 72.—THE BRITISH L. M. ERICSSON MANUFACTURING CO., LTD.—Refer to STAND No. 9.

LOGGIA No. 73.—RADIO PRESS, LTD. Also LOGGIAS Nos. 51 & 52.

LOGGIAS Nos. 74 & 75.—BURNDEPT WIRELESS, LTD.—Refer to STANDS Nos. 11 & 12.

LOGGIA No. 76.—AUTOVEYORS, LTD.—Refer to LOGGIA No. 41.

GALLERY STANDS Nos. 1 & 2.—BROWN BROS., LTD., 20, Great Eastern Street, London, E.C.2.

GALLERY STANDS Nos. 3, 4 & 5.—SELFRIDGE & CO., LTD., 400, Oxford Street, London, W.1.

GALLERY STAND No. 6.—H. J. GALLIERS, 32, St. James's Street, Brighton.

GALLERY STAND No. 7.—SYLVEX, LTD., 25, Victoria Street, London, S.W.1.

Manufacturers of the "Sylverex" crystal. The Kathoxide metal plate radio crystal is also shown.

GALLERY STAND No. 8.—H. QUARTERMAINE, Bath Road, Woking, Surrey.

Manufacturers of the Quartermaine patent gauze earthing device.

GALLERY STAND No. 9.—RADIO SOCIETY OF GREAT BRITAIN, 53, Victoria Street, London, S.W.1.

GALLERY STANDS Nos. 10, 11 & 12.—DAILY NEWS WIRELESS HOSPITAL FUND.

The stand will represent a hospital ward.

GALLERY STANDS Nos. 13 & 14.—GENERAL ELECTRIC COMPANY.

Historical exhibit relating to development of the valve.

GALLERY STANDS Nos. 15, 16 & 17.—RADIO COMMUNICATION CO., LTD.—Refer to STAND No. 5.

Marine wireless equipment.

GALLERY STAND No. 18.—RADIO ASSOCIATION, Sentinel House, Southampton Row, London, W.C.1.

GALLERY STANDS Nos. 20 & 21.—MARCONIPHONE CO., LTD.

Historical exhibit.

GALLERY STANDS Nos. 22 & 23.—MULLARD RADIO VALVE CO., LTD.

Display of transmitting valves.

GALLERY STAND No. 25.—HOBDAV BROS., LTD., 21/27, Great Eastern Street, London, E.C.2.

GALLERY STANDS Nos. 26 & 27.—SUN ELECTRICAL CO., LTD., 118/120, Charing Cross Road, London, W.C.2.

GALLERY STANDS Nos. 28 & 29.—EAST LONDON RUBBER CO., LTD., 29/33, Great Eastern Street, London, E.C.2.

GALLERY STANDS Nos. 30 & 31.—HOUGHTONS, LTD., 88/90, High Holborn, London, W.C.1.

GALLERY STANDS Nos. 32 & 33.—A. J. DEW & CO., 33/34, Rathbone Place, Oxford Street, London, W.1.

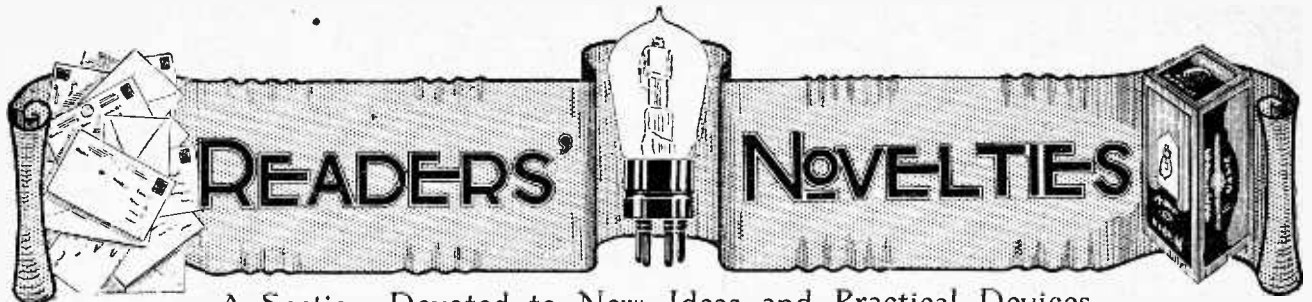

A Section Devoted to New Ideas and Practical Devices.

MOUNTING CRYSTALS.

WHEN experimenting with a series of crystal specimens which have to be held in a cup fitted with three radial screws, it is convenient to embed the crystals in Wood's metal first to prevent damage by the screws. A crystal cup is chosen with a bore slightly less than that of the detector holder, and a forcing screw is inserted in the tapped hole at the bottom.

The screw is nearly withdrawn, and a small disc dropped into the bottom of the cup. The crystal is then set in Wood's metal in the usual way, and, when cold, forced out by means of the screw. To facilitate this process it may be convenient to taper the bore of the crystal cup slightly outwards to prevent binding, and the inside of the cup should be

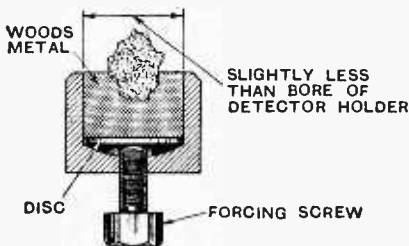

Section of mould for mounting crystals in Wood's metal.

well rubbed with a soft lead pencil before using. With the crystals mounted in this way, they may be handled without touching the active surface.—H. M. W.

o o o o

BASKET COIL HOLDER.

A neat and effective system of mounting and coupling basket coils which enables coils to be changed with the least possible delay, is illustrated in the diagram. The coils are wound on slotted disc formers cut from insulating material, such as ebonite or fibre, not less than 1/4 in. in thickness, as rigidity is essential to the success

of the scheme. In the centre of each former a square hole is cut and two contacts made from thin sheet brass

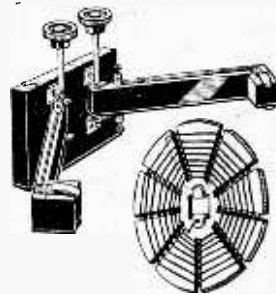

A neat holder for basket coils.

are bent round two opposite edges. The ends of the coil winding are soldered to the contacts.

The coil holder consists of two adjustable arms, each carrying a small ebonite block made to fit the holes in the coil formers. Phosphor-bronze contact springs are fitted to coincide with the contacts on the coils, and are so shaped that they hold the coils firmly against the supporting arms.

A further advantage, apart from the facility with which coils may be changed is that the connections of either coil may be reversed by taking it off and turning it through 180 degrees. A three-coil holder can be made by fitting a fixed central arm with blocks on both sides.—D. S. S.

Valves for Readers.

For every practical idea submitted by a Reader and accepted for publication in this section the Editor will forward by post a receiving valve of British make.

CRYSTAL DETECTOR.

The sketch shows a particularly neat crystal detector, which is capable of adjustment in several directions. The detector is built up in two parts, mounted on valve legs, which fit into two valve sockets in the panel of the receiver. Both the crystal and the catwhisker may, therefore, be raised and lowered or turned sideways in the valve sockets. The crystal cup may be rotated in the brass collar, and is easily withdrawn for replacement. Pairs of saw cuts are made in the collar to give the requisite amount of friction required to hold the crystal cup in position. With the



Crystal detector mounted on valve legs and sockets.

variety of movement thus obtained, it is possible to explore the whole surface of the crystal.—H. B. B.

o o o o

POLE-FINDING PAPER.

In the absence of specially prepared pole-finding paper, the ordinary blueprint paper used for machine drawings may be used. A corner of the paper is moistened, and the two leads, the polarity of which it is required to determine, are placed on the paper about half an inch apart. On removal it will be found that the paper is bleached underneath the negative lead.—N. W.

TESTING FILAMENT VOLTAGE.

In experimental work it is frequently necessary to know the value of the voltage applied across the ends of the filaments of receiving

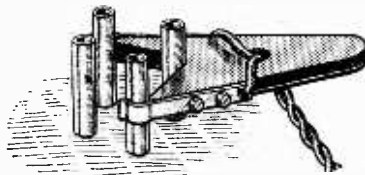

Special adaptor for testing filament voltage.

valves. If the valve holders are built with brass valve legs, the special clip illustrated in the diagram will be found very useful in obtaining a rapid reading. Two spring contacts are screwed to the sides of a wedge-shaped piece of ebonite which is cut at the wider end in the form of a V. This is done with the object of locating the contacts on the filament legs when the plate valve leg is at the bottom of the V. By this means it is impossible to short-circuit the valve legs, as the plate valve leg effectively prevents any lateral movement in the arm. Flexible leads are soldered to the spring contacts and connected to the filament voltmeter.—H. G. F.

o o o o

IMPROVED WANDER PLUG.

For making contact with the sockets in the top of a tapped H.T. battery, a brass paper clip of the type with two pointed blades and a domed cap is excellent. The blades are opened slightly before inserting in the socket, when it will be found that

sufficient side pressure will be obtained to ensure good contact.

These fasteners are suitable also for insertion in either pillar or telephone type terminals.—A. F.

o o o o

MILLIAMMETER CONNECTIONS.

When no provision is made for the connection of a milliammeter in a finished receiver, the valve adaptor illustrated in the diagram should prove useful. The plate valve leg is broken in the middle, and connections are brought out to the side of the adaptor by means of short grub screws. To these screws the milli-

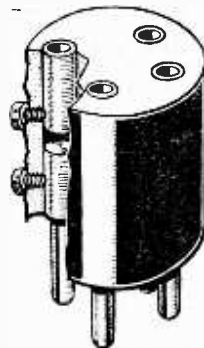

Adaptor for testing anode current to any valve in a multi-valve receiver.

ammeter is connected, and the adaptor may then be placed in any valve holder in the set, with the valve inserted at the top, and an indication obtained of the value of the anode current.—H. R. W.

o o o o

TRANSMIT-RECEIVE SWITCH.

A considerable amount of time will be saved in changing over from reception to transmission if a three-pole change-over switch of the type illustrated in the diagram is employed. The centre blade is connected to the aerial, and connects it alternatively to the aerial terminals of the transmitter or receiver. Two springs fitted to the outside switch blades make contact with semi-circular resistance elements screwed to the base of the switch on either side. These resist-

ances are connected to the transmitting valve filaments and the H.T. motor generator respectively. As the switch is moved from the "Receive" to the "Transmit" position, the motor is started up, and the valve filaments are fully alight by the time the aerial contact is closed.—J. S.

o o o o

WORKING EBONITE.

An old safety razor blade makes an excellent scraper for working the edges of panels. A special holder should be made for the blade by making a saw-cut in the edge of a small block of wood or ebonite 2in. x 1½ in. x ½ in. The depth of the slot should be such that the blade projects only ¼ in. at the edge. The blade is then clamped with two No. 2 B.A. nuts and bolts.

This tool will be found extremely useful in fitting panels to a cabinet which is not exactly square, and will be found a much more convenient method than filing in the case of many of the ebonite substitutes.—T. H. M.

o o o o

BINDING TELEPHONE CORDS.

The ends of telephone cords and other flexible leads may be prevented from fraying by binding in the manner indicated in the sketch. Thread or thin twine should be employed and well waxed before use. When the binding is completed, the free end at the right-hand side of

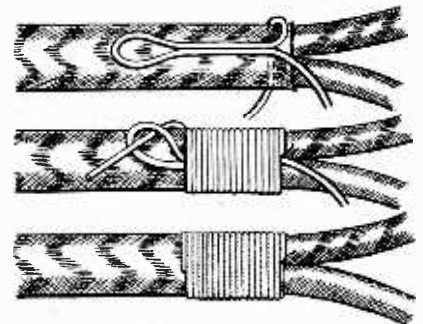

Three stages in the process of binding the ends of telephone leads.

the sketch should be pulled until the loop disappears below the turns on the left-hand side. The ends of the twine are then cut, and the frayed portions of the covering trimmed off with sharp scissors. The result is a neat binding with no external knots which are likely to wear through and break.—A. St. C.

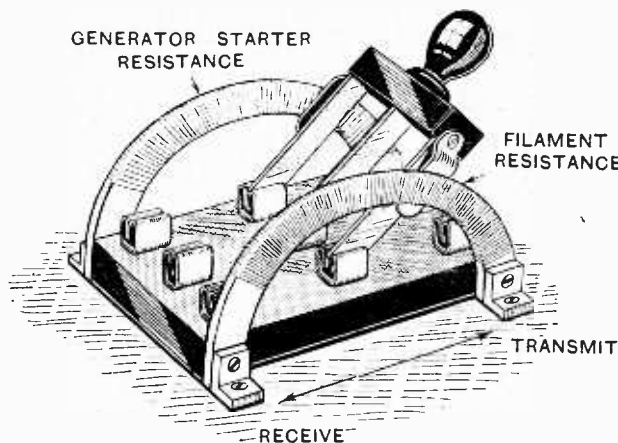

Change-over switch fitted with rheostats for the transmitting valve filaments and the motor-generator.

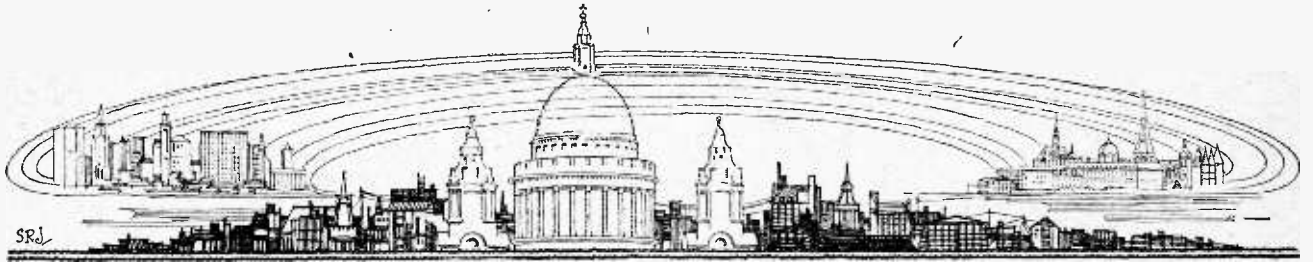

CURRENT TOPICS

Events of the Week in Brief Review.

UNWANTED AERIALS.

The Prussian Ministry of Public Instruction has requested the Government to prohibit wireless aerials on buildings of historic interest.

o o o o

TUNING-IN IN TUNIS.

Broadcast listeners who grudge payment of the 10s. licence fee would be well advised in going to Tunis, where they could set up a colony. No licence fees are demanded from Tunisian listeners, the simple requirement being that they must notify the postal authorities when installing receiving equipment. The city of Tunis has a broadcasting station of its own.

o o o o

MacMILLAN EXPEDITION SIGNALS HEARD IN BRITAIN.

The first reader to report the reception of signals from the MacMillan Expedition is Mr. R. E. Williams, of Holyhead. The s.s. *Peary* (WAP), sister ship of the *Bowdoin*, was heard quite clearly on August 31st, between 10.30 and 11 o'clock in the morning. At the time of reception WAP was working on 35 metres with New Zealand 2XA, though the latter station could not be heard at Holyhead.

o o o o

FIRST IRISH-AMERICAN DX.

In view of the almost monotonous regularity with which British amateurs now communicate with the U.S.A., it is more or less startling to learn that two-way communication has just been established for the first time between an Irish and an American amateur. This, however, is the claim of Mr. F. R. Neill (5NJ), of Whitehead, Co. Antrim, who worked with ULPL, of Boston, on August 22nd. The power used by 5NJ was just under 20 watts, and the wavelength employed was 45 metres.

o o o o

GIANT D.C. GENERATOR.

A 12,000-volt D.C. generator, stated to be the largest to be used for wireless purposes, has been installed at NKF, the U.S. Navy Experimental Station at Bellevue, Columbia. During the preliminary trials the generator blew up, but it is now reported to be functioning satisfactorily. The generator supplies energy for the 20-kilowatt transmitter operating on 75 metres.

PROGRAMMES TO ORDER.

An important innovation has been introduced by the directors of the Koenigs-wusterhausen broadcasting station. For the payment of a fee an individual listener may compile a programme of dance music or orchestral items, submitting it to the station authorities with instructions as to the time when he desires it to be broadcast. The scheme is reported to be very popular with organisers of private dances and similar functions. The fee charged for this service is approximately £2 per hour.

SEPTEMBER AS EXHIBITION MONTH.

The choice of September as a month of wireless exhibitions appears to be general throughout the world. It is interesting to note that simultaneously with the British Exhibition in the Royal Albert Hall, displays are being staged in Berlin, Tokio, and New York.

The Radio World's Fair, which is being held in the 258th Field Artillery Armoury, New York, from September 14th-19th, is the second of its kind, and, to judge from the increased space it will occupy, should awaken still greater public interest than the First Radio World's Fair, held last autumn. The 258th Field Artillery Armoury is modestly described as the largest hall in the world.

o o o o

U.S. AMATEURS HEARD IN SOUTH AFRICA.

Despite the greater distance, amateurs in South Africa appear to find less difficulty in picking up signals from America than from England.

During the last few weeks two members of the American Radio Relay League resident in South Africa have compiled extensive logs of American amateur stations. Mr. C. Ochse, of Hanover, Cape Province, has heard many American 9th district transmitters, while Mr. A. S. Faull, of Strand, Cape Province, has picked up U7CU, of Aberdeen, Washington.

o o o o

PROPOSED BELGIAN TRANSMITTING REGULATIONS.

Although amateur transmitters in Belgium are at present without official recognition, it is understood that the authorities will shortly grant transmitting licences on the following conditions:—

(a) Fixed and portable stations for private intercommunication. Maximum input 200 watts; wavelengths 150 to 200 metres.

(b) Broadcasting stations. Maximum input 5,000 watts; wavelengths 220 to 280 metres, or 1,000 to 1,050 metres.

(c) Stations for testing and scientific research. Power and wavelengths not fixed.

(d) Amateur stations or those used for demonstration. Maximum input 30 watts; wavelengths 45 to 50 metres, 95 to 105 metres, and 180 to 200 metres.

The annual licence fee will be from 100 to 200 francs, according to the nature of the installation.

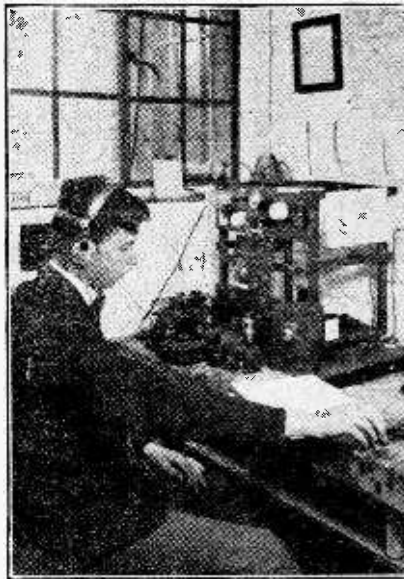

AN IRISH TRANSMITTER. Mr. Eric Megaw (G6MU), of Belfast, who holds one of the first amateur transmitting licences granted in Northern Ireland.

DIRECTIONAL WIRELESS AT SEA.

The Board of Trade Committee recently appointed to enquire into the various systems of directional wireless telegraphy and other aids to navigation has held its first meeting. The chairman, Sir R. Burton Chadwick, Parliamentary Secretary of the Board of Trade, has appointed a small sub-committee to deal with the technical evidence.

**WIRELESS WINDOW DRESSING
COMPETITION.**

A novel feature of the Wireless Exhibition will be a competition arranged by the Radio Communication Co., Ltd. Twelve alternative displays are to be arranged in the special window fitted to Loggia Box No. 67. The displays will be changed sufficiently frequently to cover each of the twelve selected displays daily.

Competitors will be required to fill in a form placing the twelve displays in their order of merit, the winning competitors being those whose lists most nearly approximate to the general vote. The first prize will be £25, the second and third being £15 and £10 respectively.

○○○○

NEW A.J.S. SHOWROOMS.

Thursday, September 10th. is to witness the opening of new wireless showrooms at 122-124, Charing Cross Road, London, W.C.2, by Messrs. A. J. Stevens and Co. (1914), Ltd. A large basement will contain the store and trade counter, while the ground floor will be devoted to retail sales. A well-appointed demonstration room will occupy the first floor, and a special department is being formed to render "after sales" service.

○○○○

AMERICAN BROADCASTING ANOMALY

A special "personal programme" addressed to members of the MacMillan Arctic Expedition now off the coast of Greenland is broadcast at midnight every Wednesday (6 a.m. Thursday, G.M.T.) from the Zenith Station WJAZ at Straus Building, Chicago, on 268 metres.

The fact that "the programmes are intended solely for the members of the Expedition" appears to have attracted a large number of American listeners, many of whom have forwarded enthusiastic reports to the station. The indications are that the officials at WJAZ would not be averse to receiving reports from British listeners.

○○○○

LONG-RANGE SINGLE-VALVE SET.

The author of the article appearing under this title in the issue of August 26th, 1925, desires us to point out that subsequent experience with the set has shown that a value of 0.006 mfd. for the fixed condenser connected across the quenching coils gives better results than the value of 0.005 mfd. used in the original experiments.

○○○○

MOBILE BROADCASTING STATION.

Very successful experiments are being carried out by the Zenith Portable Broadcasting Station, WJAZ, which is at present touring the States of Ohio and Michigan. The tests are said to have proved the practicability of transporting a station, without dismantling, over all kinds of roads in all sorts of weather. One advantage of such a station is declared to be the ease with which it could be rushed to scenes of exciting occurrences or disasters. The mobile station is also useful for studying the conditions of reception in different localities.

A 44

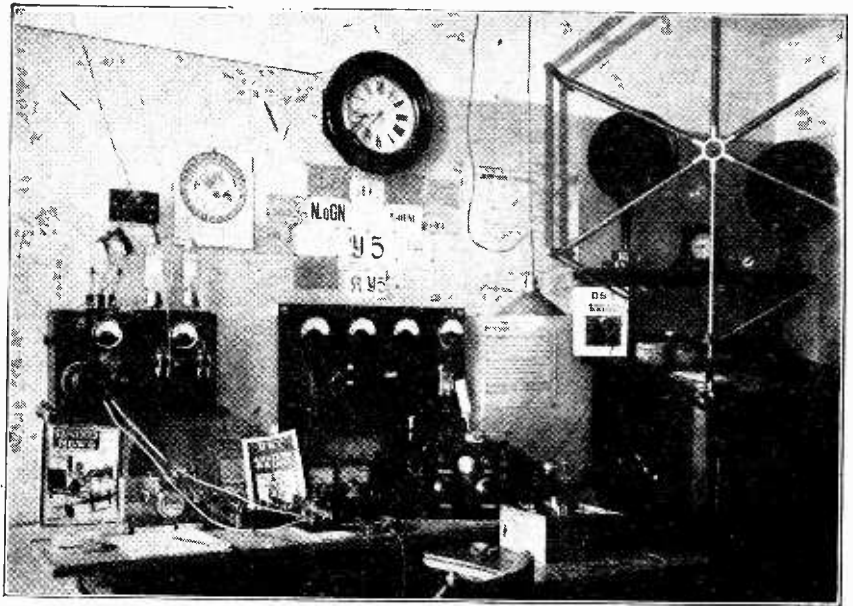

GERMAN AMATEUR ACTIVITY. The gradual slackening of official restrictions on amateur wireless in Germany is resulting in a growth of transmitting activity. The photograph shows the equipment at KY5, a new station owned by Herr F. Sabrowsky, of Stuttgart.

**SHORT WAVE TESTS FROM
MANCHESTER.**

A useful series of short wave transmitting tests is being conducted by the Manchester Wireless Society from their experimental station 6MX.

The following schedule of transmissions will be observed, G.M.T. being given in each case:—*Saturday*, 6.30 to 7 p.m., 45 metres; *Sunday*, 7 to 7.30 p.m., 90 metres; *Wednesday*, 5 to 6 a.m., 25 metres. The following is an example of the order of transmission:—*Test de G6MX, QRA Manchester, QRH 90* (giving wavelength), *P50* (denoting input in watts), *A1 1.5 or pnt 5* (radiation), *1^{re} QSL AR K de G6MX*.

Special tests can be arranged and members of the Society are prepared to report on the reception of any transmission, from any part of the world. Experimenters willing to co-operate in tests on 3 to 5 metres should notify the hon. secretary as early as possible.

All communications should be addressed to the hon. secretary, Mr. Y. W. P. Evans, 66, Oxford Road, Manchester.

○○○○

**FIRST NORWEGIAN AMATEUR
TRANSMITTER.**

Although amateur transmission is still forbidden in Norway, a special permit for private experiments with low power has been granted to Mr. J. Diesen (LAI), of Moen i Maalselv. On August 20th LAI established two-way communication with G5TZ, the station of Mr. W. G. Sherrat, of Cowes, I. of W.

Mr. Diesen would be glad to receive reports from British amateurs. He works on wavelengths of 40 and 120 metres

POLYTECHNIC WIRELESS COURSES.

Complete tuition in the technique and practice of wireless communication is afforded by the Polytechnic Wireless Courses, enrolment for which can be made from September 16th to 25th (19th excepted) between 6.0 and 8.30 p.m. The classes are held in the evening. The three courses, which extend over a period of three years, cover wireless and high-frequency engineering, electrical technology, practical mathematics, and alternating current work. Instruction is also given in the operation of a modern valve transmitter for telegraphy and telephony.

A copy of the syllabus and particulars of fees may be obtained from the Electrical Engineering Department, the Polytechnic, 307-311, Regent Street, London, W.1.

○○○○

**WIRELESS AT THE EDINBURGH
OBSERVATORY.**

The Annual Report of the Astronomer Royal for Scotland emphasises the value of radiotelegraphy in enabling distant observatories to compare their times with great precision. Astronomers have been considerably perturbed at their lack of agreement, and Professor R. A. Sampson, F.R.S., the Astronomer Royal for Scotland, set himself the task of searching for the cause of the errors found to occur at all observatories.

He now makes the definite statement that "owing to improvements in the clock and chronograph system in this observatory and in receiving apparatus for W.T. signals from other observatories, it has proved possible to bring this investigation to an issue." So far as the Edinburgh Observatory is concerned, adds Professor Sampson, the source of these discrepancies appears now to be located.

The Brandola!

Experts in radio acoustics since 1908

To capture an electrical impulse and transform it to audible sound is easily accomplished in this age of advanced radio. To reproduce that sound in its original purity and texture, without a suggestion of alien influence, is quite another matter. Our long and intimate association with the "voice of radio" has, of course, necessitated minute and exacting study of acoustics—the science of sound.

Radio acoustics is the science of transforming the electrical impulse into audible sound, and Brandes have been engaged in this absorbing study of *real* reproduction of voice and music since 1908. The expert knowledge thus accumulated shows itself in the unique principles embodied in the *Brandola*, our latest and most perfectly developed Speaker.

Any reputable dealer stocks Brandes.

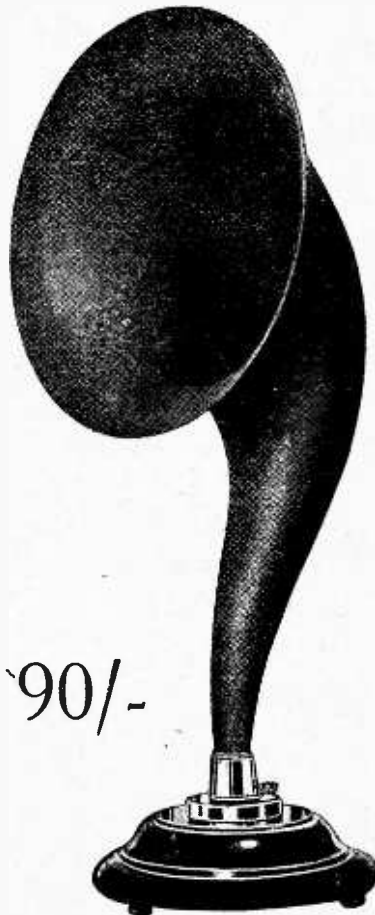

90/-

Our most perfectly developed "speaker"

The *Brandola* will be for those who demand supreme performance. Its large adjustable diaphragm gives new rounded fullness to the low registers and new clarified lightness to the high, together with luxuriant depth of volume. Special constructional features ensure greatest volume with minimum current input and exceptional clarity over the full frequency range. The semi-gooseneck horn has a distinguished "antique" finish, and is constructed of non-resonant material which defeats harsh or metallic resonance. The base is of polished walnut with electro-plated fittings. Substantially yet elegantly built, the *Brandola* will harmonise effectively with any decorative scheme. Height 26¼ ins., diameter of bell—12¼ ins.

Ask your dealer for the Brandola.

Brandes

Brandes, Limited, 296, Regent St., W.I. Works: Slough, Bucks.

Three other famous Brandes products.

The Table-Talker



Re-designed gooseneck horn which produces clear, more rounded and mellow tones. Constructed of special material which defeats any suggestion of metallic resonance. The adjustment lever, located at the rear of base, controls the volume and sensitivity. 18" high, diameter of bell 10". 30/-

Matched Tone Headphones

Every pair of Brandes phones is matched in tone by special apparatus so that the two receivers produce exactly the same sound at the same instant. Comfortable and light in weight with clutch on headband giving perfect adjustment to any head. Included in the leading types of completely equipped receiving sets 20/-



Audio Transformer

Ratio 1 to 5. Developed along sound engineering lines to give high amplification of applied voltage with straight line amplification - frequency curve. Well protected mechanically with shielding so that interaction is eliminated. With outside soldering tags, screw terminals and screw mounting base. On comparative test the extra volume and clearness of this transformer are immediately noticeable.



17/6

In answering this advertisement it is desirable to mention "The Wireless World."

Electrifying Time

HERE at last is a clock which keeps accurate time, requires no attention, and no winding.

No matter how many Slave Clocks you may instal in your house, offices or works, each one will show the identical time.

The PRINCEPS ELECTRICAL CLOCK

is different in principle to any other system in existence, and has solved the difficulties which have puzzled the minds of horologists throughout the centuries.

Princeps Master Clocks cost from £10:0:0, and Slave Clocks from £2:5:0.

"The Book of the Princeps Electrical Clock," giving a full description of its operation, can be obtained on request.

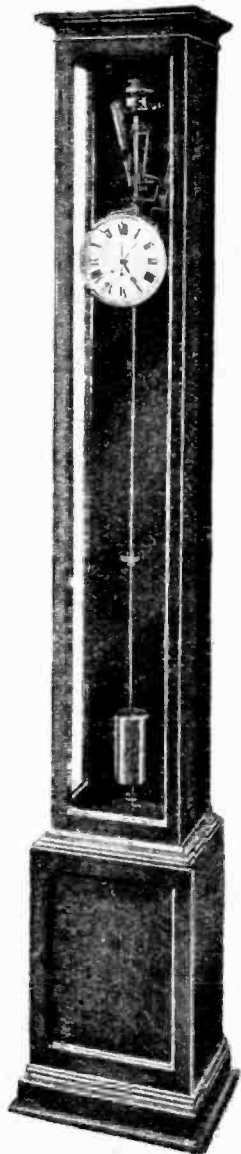

Write to

PRINCE'S ELECTRICAL CLOCKS LTD.
173, New Bond Street, London, W.1.

Telephone: Gerrard 1142.

Telegrams: Princelox, Elected.

The Ezi-Wiring Series

*Provides the Quickest
and Most Simple
Method of Wireless
Construction* ❦ ❦ ❦

The "Ezi-Wiring" series represents a definite and welcome innovation for the constructor possessing little or no technical knowledge, and who wishes to build instruments of high efficiency with minimum trouble and expense. *The wiring diagrams are shown in four colours—* a unique feature which reduces the possibility of incorrect wiring. In addition, advice regarding the choice of components and building and operating instructions are given. Each book contains four plates.

- (1) "A THREE-VALVE PORTABLE RECEIVER,"
by HUGH S. POCOCK.
Price 2/- net. By post 2/2.

This receiver can be used in any situation with a temporary aerial or with the frame aerial incorporated in the receiver itself.

- (2) "A THREE-VALVE RECEIVER,"
by F. H. HAYNES,
Price 2/- net. By post 2/2.

The tuning arrangements of this receiver are self-contained and cover a band of wavelengths between 200 and 2,000 metres. All the B.B.C. Stations are therefore within the range of this receiver when used in conjunction with an average outdoor aerial. A straightforward three-valve set, consisting of a high-efficiency amplifier, detector and note magnifier, with re-action on the aerial inductance.

- (3) "A TWO-VALVE AND CRYSTAL REFLEX
RECEIVER," by W. JAMES.
Price 2/- net. By post 2/2.

Reflex receivers are capable of giving a very high degree of amplification per valve. This two-valve and crystal receiver, unlike many reflex receivers, will be found perfectly stable in operation and will be capable of giving loud-speaker strength within a radius of thirty miles of a main B.B.C. station.

- (4) "A FOUR-VALVE COMBINATION SET,"
by W. JAMES.
Price 2/- net. By post 2/2.

A four-valve receiver of this type is ideal for general reception both with telephones and a loud speaker. Switches are provided so that two, three, or four valves may be used at will. An entirely new principle is used to cut out the H.F. valve, no switches being employed. Loud speaker results from most of the British and Continental Broadcasting Stations can be obtained with this receiver.

Obtainable from Booksellers and
Wireless Stores; or direct from the
Publishers of "The Wireless World,"

ILIFFE & SONS LTD.,
Dorset House, Tudor Street,
London, E.C.4.



W.W.6

THE CRYSTAL AMPLIFIER

Detailed Instructions for Operating the Receiver.

By L. L. BARNES.

THE manipulation of the oscillating crystal receiver may at first present a certain amount of difficulty, but after a time the experimenter will be sufficiently familiar with it to find that the operation is almost as straightforward as that of a single-valve receiver.

The conditions governing oscillation are controlled by the potential applied to the oscillating crystal Z, this being controlled by the potentiometer P and the variable resistance V. The inclusion of the latter in the circuit is desirable, though not essential, its function being auxiliary to the potentiometer in giving a fine adjustment of the potential difference across the crystal.

It is very necessary to visualise the connections to the potentiometer and variable resistance, in order that, while the set is in action, one may be quite clear as to the exact effect produced by moving the sliders (or switch arms) of these components in any given direction.

Difficulty arises from the fact that alteration of the value of the potential applied to the oscillating crystal seriously affects the tuning. Incidentally, this is in no way due to change of inductance through introducing more (or less) of the potentiometer winding into the circuit, for when a non-inductive potentiometer is used precisely the same effect is observed. And so, while receiving telephony, the process of elimination of distortion consists in altering the value of applied voltage, then of necessity retuning, readjusting the potentiometer, again retuning, and so on until the required result is obtained.

That these instructions shall be complete, it will be necessary to specify in order the various operations involved in tuning-in any desired signal.

Adjustment of the Crystal Detector.

Connect up aerial, earth, telephones, and battery (with special care as to polarity in the last case). Leave all three switches, I, M, and N open; plug in suitable coils, turn the condenser C_2 to zero, and the circuit then in use is nothing more than a straight crystal circuit with loose-coupled primary and secondary coils, thus enabling one to adjust the detecting crystal to give best

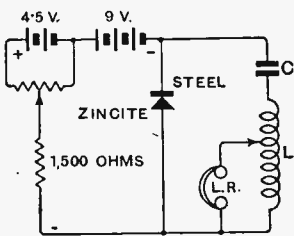

Fig. 12.—Circuit for testing the oscillating properties of a crystal.

In the previous issue constructional details were given of a receiver making use of the oscillating and amplifying crystal. The present article deals with the manipulation of the tuning controls and the adjustment of the crystal amplifier. Some suggestions for further lines of research for the experimenter are given at the conclusion of the article.

results on any spark or telephony station that can be picked up.

It may be noticed in passing that this method of reverting to a straight crystal set simply by turning C_2 to zero—it being unnecessary to switch off the battery even when the crystal booster is in an oscillating condition—proves extremely useful, as it enables one very readily to make a comparison of the strength of the actual signal with that when amplified (though it will be necessary to retune the primary by means of C_1).

Adjustment of the Crystal Booster.

Having adjusted the crystal detector, we may turn our attention to the crystal booster.

Loosen the coupling of the two tuning coils, turn C_2 to maximum capacity, and close switches M and L. Move the slider of the potentiometer nearly to maximum, and then put the steel catwhisker into contact with the zincite. A point capable of maintaining oscillation is indicated by sharp, loud clicks in the 'phones, and it is necessary to search for such a point; then adjust the pressure of the steel contact (which is usually very light) until a "mush"

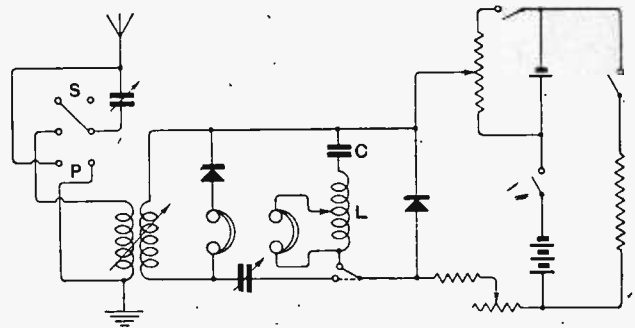

Fig. 13.—The original circuit, including an alternative low-frequency arrangement for setting the crystal oscillator.

is heard. The set is then oscillating, and a moist finger tapped on the upper terminal of the left-hand (secondary) coil produces the characteristic clicks that are obtained from an oscillating valve receiver.

Next tighten the coupling until the coils almost touch each other, and turn C_2 slowly. If the "mush" ceases after turning the condenser through only a few degrees, the potential applied to the crystal is too great, and must therefore be reduced slightly by means of the potentiometer. In most cases it is convenient for adjustments of voltage to be such that the "mush"

The Crystal Amplifier.—

ceases when the condenser C_2 is at about its mid-position.

If on turning C_2 from maximum towards minimum oscillation ceases with a "thud," and does not recommence until the condenser is turned back again almost to maximum, insufficient voltage is indicated, and the potentiometer must therefore be adjusted accordingly.

For any given setting of the crystal booster, when the "mush" is first obtained, it is advisable to wait about ten seconds to allow the "mush" to stabilise.

Tuning.

C.W. is most easily tuned in, and will therefore be considered first.

C_2 is turned slowly from its maximum capacity, until the required signal is heard: extreme sharpness of tuning is a sign that the potential is too little, and can be increased by means of the potentiometer. Any or all of four operations can now be performed to increase the strength of the C.W. signal:

- (1) Alteration of coupling.
- (2) Alteration of C_2 .
- (3) Alteration of C_1 .
- (4) Alteration of variable resistance V .

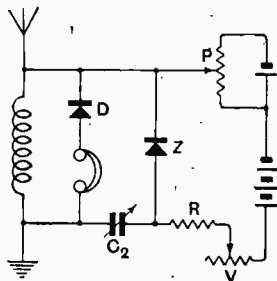

Fig. 14.—Simplified circuit arrangement, dispensing with the coupled tuning circuit.

In practice this can be done very quickly after a little experience, and the perfect stability of the pitch of the C.W. note is really striking.

Spark can also be received without much labour, as the signals need not necessarily be free from distortion to be quite readable. One has only to listen on the 600-metre wavelength to realise the remarkable increase in range of this type of crystal receiver.

In any part of this country one should be able with care to tune-in successfully telephony from most B.B.C. and several Continental stations. In the amplification of strong signals (e.g., of the local broadcasting station) the set must not be too near the point of oscillation if the reception is to be without distortion. It has already been noted that oscillation gradually ceases on turning the condenser C_2 towards zero. Distant telephony is first detected by the howl of the carrier-wave.

The art of tuning-in such signals is so to adjust the variable factors of the circuit (voltage, coupling, etc.) that by turning C_2 to a certain position oscillation is on the point of ceasing at the same time that the set is tuned to the wavelength received.

The sizes of inductance coils required for any particular wavelength are best found by trial, but it is generally found that results are most satisfactory when the secondary coil is one size smaller than the primary. Thus for the broadcast wave-band, the required coils are primary (A.T.I.) No. 75, with aerial tuning condenser in series, and the secondary, No. 50.

Special note should be made with regard to changing coils. Stable oscillation may be established for one coil, but if this is changed for one of a different size, it will

be found necessary to alter the voltage correspondingly before the "mush" indicating the presence of oscillation recurs. The rule is that increase of wavelength requires decrease of potential, and *vice versa*.

Should it be thought that by some means (e.g., jarring) the crystal booster is put out of adjustment, perform this simple test before disturbing it. Adjust the potentiometer to give maximum voltage, and the variable resistance to zero; open and close the switch L (introducing the potentiometer battery). If loud "woolly" clicks are heard in the telephones, the booster is in perfect adjustment, and decrease of voltage is all that is required. If only faint clicks are heard, the booster must be re-adjusted in the manner already described.

Sometimes, in the process of reception, persistent howling masks all signals. This can be got rid of to some extent by suitably reducing the voltage, but it is really an indication that the resistance of the detecting crystal is too low, and a lighter contact should therefore be employed; it was for this reason that the importance of a high-resistance detector was emphasised in the constructional details.

If occasionally happens that the potential required by the oscillating crystal is such that no extra voltage is required to be supplied from the potentiometer, in which case the switch L is simply left open, and the potentiometer P acts in the same way as the variable resistance V (there is a right and a wrong position for the switch L in the potentiometer circuit, therefore). For very high wavelengths it may even be found necessary to reduce the potential still further by reversing the polarity of the potentiometer battery, and closing the switch L again.

To Switch Off the Battery.

Throughout experiments, one of the main points to be kept in mind is the necessity of preserving the stability of the crystal booster, in order to avoid the inconvenience of readjustment. Before switching off the main battery,

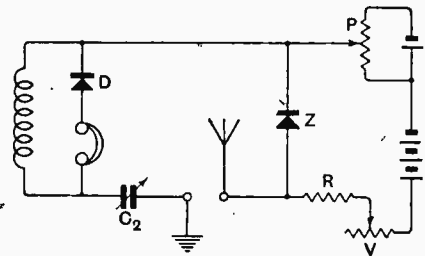

Fig. 15.—Experimental modification of the original circuit, in which the input from the aerial system is connected in series with the tuning condenser C_2 .

it is necessary to shunt it with the low resistance S. When it is required to "close down," therefore, the process is as follows: Open switch L, close switch N, open M, open N. If this precaution is not taken, and M is opened without first closing N, it will be found that the crystal booster requires readjustment on the next occasion that the set is used—and here lies the importance of sound moving contacts in the potentiometer and variable resistance. If the inductance of the battery circuit is small it may not always be necessary first to introduce the shunt S, but if the stabilising resistance R takes the form of a choke, the above precaution is invariably

The Crystal Amplifier.—needed—this is one of the many points requiring investigation.

In switching on the battery, the switch N may be used regardless of the value of inductance in the circuit.

Testing the Zincite Crystal.

If the specimen of zincite happens to be ineffectual from the point of view of amplification, it will be found impossible to obtain the "mush" already referred to in the description of the setting of the crystal booster, in which case it is desirable to have apparatus by which the zincite crystal can be tested. The circuit is given in Fig. 12, and the components can be mounted to form a

tain oscillation before switching over, otherwise oscillation may fail to recommence.

The oscillating crystal is perhaps more easily set by this method, but the extra labour involved in the construction of the condenser and inductance is hardly justified if these are intended for the one purpose only, as the method already described of adjusting for a "mush" is quite satisfactory.

Items for Research.

Innumerable lines for investigation will suggest themselves as soon as the experimenter has become accustomed to the manipulation, and it is then that he will appreciate

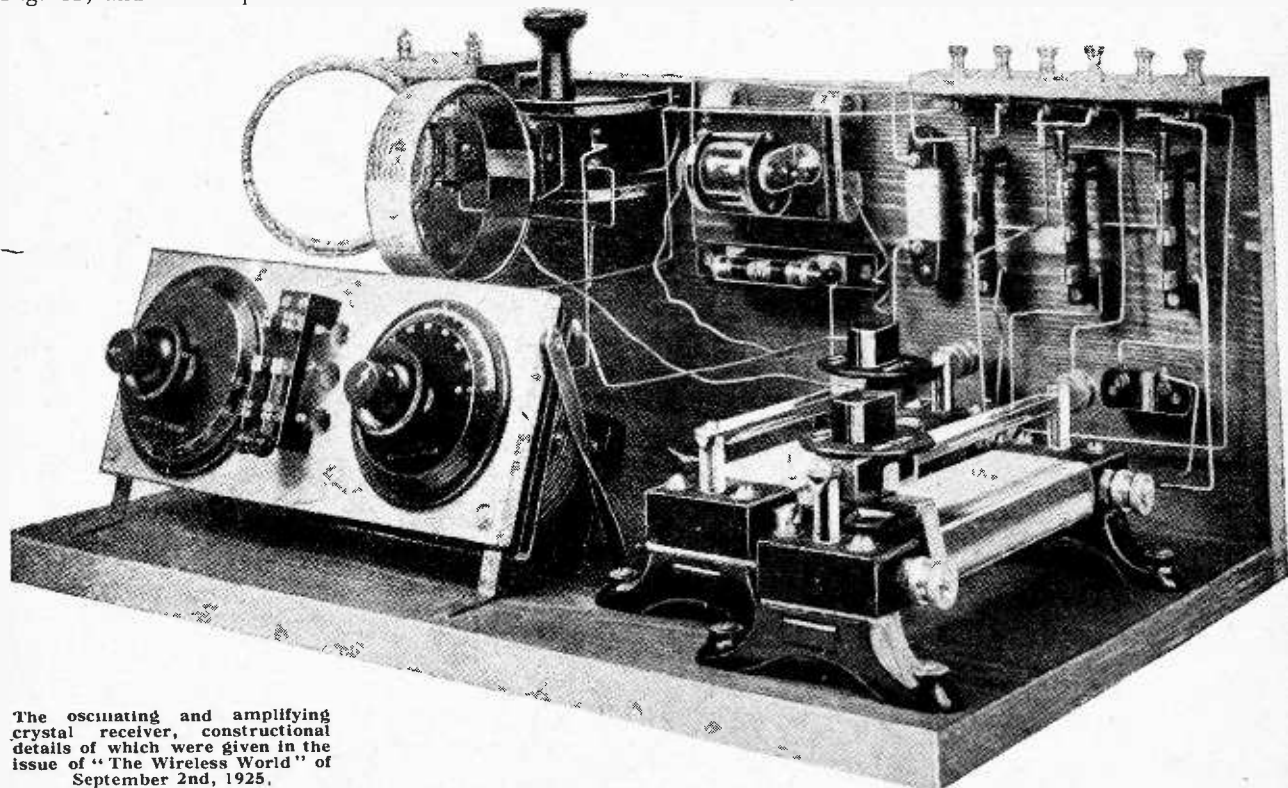

The oscillating and amplifying crystal receiver, constructional details of which were given in the issue of "The Wireless World" of September 2nd, 1925.

unit which local radio societies would find a valuable acquirement for the use of members.

For those wishing actually to construct this apparatus, the condenser C has a capacity of about 0.25 mfd. The inductance measures approximately 30 millihenries, and can be made by winding 150 yards of No. 28 S.W.G. D.C.C. copper wire on a cylinder 3in. long by 1in. diameter. A low-resistance telephone is shunted across part of this inductance.

The crystal, if "sensitive," will, when correctly adjusted, maintain oscillations in the tuned circuit CL, and a musical note will be audible in the telephones. If the apparatus has been installed for the purpose of testing crystals, it can also form part of the receiving circuit, so that the crystal booster is adjusted to oscillate in the low-frequency circuit, and is then switched over to the radiofrequency receiving circuit.

Having established oscillations in the circuit CL, the potential should be reduced to a value insufficient to main-

terminal connections to the components. For example, the set can very easily be converted into one employing the circuit given in Fig. 14, by dispensing with the primary coil and condenser, and connecting the aerial and earth on to the secondary.¹ Or, again, the aerial and earth can be connected in series with C₂, as in Fig. 15. Both these circuits yield quite good results, though they are, of course, not so selective as one employing two tuned circuits. With the set that has been described, it is possible at a distance of ten miles from a main B.B.C. station to tune out that station and receive others working on the broadcast wave-band, though selectivity such as this is obtained only through patient manipulation of the "variables."

¹ Since writing this article, "New Facts About Oscillating Crystals" has been published (*The Wireless World*, August 19th, 1925), and I note that the arrangement I have suggested constitutes the basic circuit used in the experiments of Capt. Round and Mr. Rust.—L.L.B.

The Crystal Amplifier.—

The stabilising resistance R must be inductive. What is the value of this inductance for best results? Should it be only a few turns of fairly large diameter, or should it be at the other extreme, a choke? This is a suggestion that would form the basis of quite a straightforward line of experiment.

What is the best detecting crystal when used in conjunction with a crystal amplifier? It certainly has a very important bearing on selectivity and ease of control of oscillation.

A simple method of preventing the troublesome low-frequency howls already alluded to when a low resistance detector is used would also be extremely valuable.

A system can be brought just off the point of oscillation by balancing the negative resistance by means of a variable positive resistance placed in the oscillatory circuit. Experimenters may find this a useful asset to the circuit.

The inclusion, for experimental purposes, of a milliammeter in series with the battery will indicate the approximate point on the characteristic curve of the crystal at which one is working, and therefore the corrections to be made in the adjustment of potential, thus narrowing the field of the experimental operations.

Normally, successful results are obtained when the crystal passes from 2 to 3 milliamps. The milliammeter will, however, give only a rough indication of the adjustment to be made, as unfortunately the characteristic curves of different specimens of zincite—and even of different points on the same crystal, though always of the same form, are not identical. It is for this reason that

adjustments for good reception of a certain station are correct for only one setting of the crystal booster.

Another oscillating crystal that would be more easily adjusted and mechanically more stable than the zincite-steel, would be of immense value.¹ A search for such proves itself a straightforward though somewhat monotonous task, as probably the only ready test is to assemble the circuit for low-frequency oscillation (Fig. 12), and try various crystals each with a varied value of applied potential. The criteria for a good oscillating crystal are:—

- (1) Electrical stability.
- (2) Mechanical stability.
- (3) Economy of consumption.

Greater reliability, and simplification of operation must be realised before the crystal amplifier can pass from the hands of the experimenter and become a commercial success. The reader must not be deterred, however, by the somewhat lengthy description of manipulation that has been here set out. After a very little experience one will make the various corrections instinctively, and tuning-in will be found in no way the laborious task which might be inferred.

It must be remembered that failure can always be attributed either to faulty construction or faulty manipulation, and experience shows that in the case of this apparatus it is usually the latter.

¹ At the time of writing, the discovery of the oscillating properties of "arzenite" by Capt. Round and Mr. Rust, had not been disclosed.—I.L.B.

General Notes.

B4US, c/o Radio Club Belge de l'Est, Rue Tranchée, 50, Verviers, would be glad to receive confirmation of reception of his signals by Corpl. B. Bond, Palestine.

Mr. W. Beck, 10, Upper Duke Street, Hulme, Manchester, reports hearing a station O5X (presumed to be in South Africa), transmitting on about 40 metres at 12.10 a.m. (B.S.T.), on August 28th, and asks if any other reader heard this station.

Mr. Rolf Formis (KY4), Alexanderstr. 31, Stuttgart, will be very pleased to forward communications to German amateurs.

Mr. Alan Smith (G6VP), 48, High Street, Yiewsley, Middlesex, works on 90 metres every night from about 22.00 B.S.T., and is able and willing to report on transmissions by French amateurs.

Col. M. J. C. Dennis (11B), Fortgranite, Balinglass, Ireland, will welcome any reports from experimenters in England and France. He transmits almost daily on 150 or 175 metres after B.B.C. hours but, according to the terms of his licence, his transmission is limited to communication with stations in Southern Ireland.

We would remind enquirers who write to transmitters asking for the QRA's and other particulars of stations with which they are working, to enclose stamps for reply. The amount of correspondence received by some active amateur transmitters is very great, and entails con-

TRANSMITTER NOTES AND QUERIES.

siderable expense in replying to queries. This, of course, does not refer to the ordinary QSL card, but to special enquiries.

Stations Identified.

Several correspondents have kindly given us the QRA's of various amateur transmitters in distant countries, which will probably prove of interest to other readers:—

Bermuda:—BE1. Major Cookson, Hamilton; BER, W. F. Hoisington, Hamilton. *Brazil*:—BZ1AB, A. S. Freire, 46, via Oswaldo Cruz, Echarahy. Nichtheroy; BZ1AF, C. de Almeida, 117, Rua Boliva, Rio de Janeiro; BZ2SP, 2 Rua Frei Caneca 22, São Paulo. *Chile*:—1EG, E. Guerara, Casilla 69, Vilem; 9TC, R. R. Hart, Los Andes. *French Indo-China*:—HVA, M. Mirville, Hanoi. *Hongkong*:—XAL, Tang Fong Laun, Man Chu Tai, 35, Connaught Road, West. *Luxembourg*:—LOAA, F. Anen, Rue Beaumont. *Madeira*:—P3CO, A. C. de Oliveira, c/o Western Telegraph Co., Box 56, Funchal; R31, H. T. Gomez de Freitas, Janeiro 141, Funchal. *Mexico*:—M1AA, J. Prieto, Avenida 14 No. 31,

Tacubaya D.F.; M1AF, J. Rios, 2A, Hidalgo 44, Tacubaya D.F.; M1B, M. Perusquia, P.O. Box 540, Mexico City. *Norway*:—LA1, J. Diesen, Moen i Maalselv. *Salvador*:—FMH, J. F. Mejia, 14, Avenida Norte No. 21, San Salvador. *Yugo-Slavia*:—Y7XX, M. Torbarina, Gruz, Dalmatia.

CIAR.—J. J. Fassett, "Woodside," Pleasant Street, Dartmouth, Nova Scotia.

G2YT.—Marconi Test Station, Poldhu.

M1DH.—Sergt. Hall, No. 6 Sqdn., R.A.F., Mosul, Iraq. (This station used to operate with call sign GHH.)

MAROC (temporary call pending issue of official call-sign). G. Grangier, P.O. Box 50, Casablanca, Morocco.

NTT.—The yacht of the U.S. High Commissioner to Turkey, at present at Varina. QSL cards should be addressed to C. W. Bailey, U.S.S. "Scorpion," c/o U.S. Dispatch Agent, 6, Grosvenor Gardens, S.W.1.

QRA's Wanted.

Can any of our readers give us the names and addresses of the owners of the following stations? Should any correspondent wish the information to be regarded as confidential he should indicate this in his letter:—

S5NF, 6ZK, 2AOB, H9BR, F8VO, BZ, 1AP, FBI, XY, LA1, OCTU, AGA, B4RS, BZ1AP, C9CH, FOCDJ, F8PRI, F8FIR, FTJ, H1BR, KXH, M1DH, M1K, M4HS, NOXW, NOFP, NOTH, NOHB, NOBA, POF, RDW, SOK (Poland, -working RCRL), Z2AX, 22A, 22R, Mosul 1DH, Maroc.

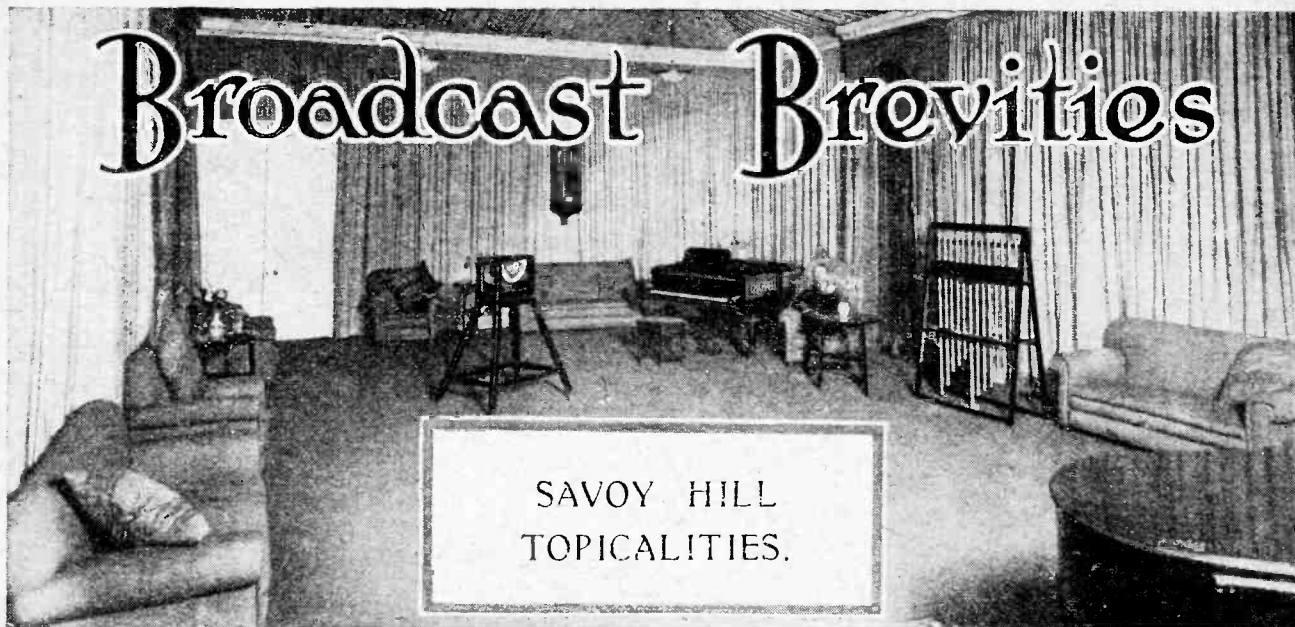

Forthcoming Talks.

The serious attention which is given to the choice of subjects for wireless talks and the equally careful choice of speakers indicate that broadcast is going to play an important part in the education of the future. History, music, art, coinage, the drama, humour in literature, and philosophy are a few of the topics appearing in the programmes for autumn and winter.

o o o o

Other Subjects.

Mr. J. Reid Moir will talk from London on "Man Before History," in a series extending from September 23rd to November 11th. His talks will be on such subjects as "Man's Great Antiquity," "East Anglians of 500,000 Years Ago," and "The Men of the Cromer Forest Bed." M. E. M. Stephan is continuing during the autumn the series of French talks under the auspices of the Institut Francais. The series will be given weekly from September 21st to October 26th. There will be a break during November, and further talks appropriate to the season will be given during December.

o o o o

At Nottingham.

Dr. E. K. Barton, in a series of six weekly talks from the Nottingham station on "Musical Sound," will incorporate musical illustrations of the different instruments used in an orchestra, such as the strings, the "wood-wind," and the brass.

o o o o

Oxford University.

Two further series deserve special mention; these are the lectures which are to be relayed from a studio specially provided by the B.B.C. at Oxford University. One of the series will be Professor Gordon's lectures on "Humour in the Great Books," and the other series will be that of Professor Julian Huxley, deal-

FUTURE FEATURES.
Sunday, September 13th.
 LONDON.—3.30 p.m., Mendelssohn's Oratorio, "St. Paul." 9 p.m., De Groot and the Piccadilly Orchestra.
 LEEDS-BRADFORD.—9 p.m., Reception to the British National Opera Company.
Monday, September 14th.
 5XX.—8 p.m., "Rigoletto" (Verdi), Acts II. and III.
 BELFAST.—7.30 p.m., "Stars of Eve."
Tuesday, September 15th.
 5XX.—8.30 p.m., "Winners," a Revusical Extravaganza.
 ALL STATIONS (except 5XX and Leeds-Bradford).—8.30 p.m., "The Magic Flute" (Mozart), Act II.
Wednesday, September 16th.
 5XX.—9.15 p.m., "The Tales of Hoffmann" (Offenbach), Act III.
 NOTTINGHAM.—8 p.m., 5NG's Birthday Concert.
Thursday, September 17th.
 5XX.—9 p.m., "The Mastersingers" (Wagner), Act III.
 LONDON.—9 p.m., String Orchestral Programme.
 MANCHESTER.—8 p.m., Excerpts from Light Opera.
 ABERDEEN.—8 p.m., Ladies' Night.
Friday, September 18th.
 BOURNEMOUTH.—8 p.m., Concert Party Night.
 NEWCASTLE.—8 p.m., "Happy Days of Childhood."
Saturday, September 19th.
 LONDON.—9 p.m., "Radio Radiance."
 BIRMINGHAM.—8 p.m., Popular Orchestral Programme, relayed to 5XX.

ing with evolution, and entitled "The Stream of Life." Professor Huxley is the grandson of that famous scientist, Thomas Henry Huxley. In addition, the B.B.C. will relay the performances of the O.U.D.S., special religious services, and other features of outstanding interest in the life of the University.

o o o o

To What Base Uses—

In another way, I am reminded, the B.B.C. has associations with a famous University, i.e., Edinburgh, where the transmitting station reposes within the dignified silence of the New University buildings. The reason is that there is a chimney in that retreat of the alumni, and Edinburgh is particularly badly off for such smoke-producing, yet useful contrivances.

o o o o

Edinburgh Aerial.

By virtue (or otherwise) of the disposition of the surrounding buildings, the Edinburgh aerial is of unique shape. Commencing at the top of the chimney, one section of the "sausage" is guyed on to a roof. From that point another section makes its way to the transmitting house at the base of the stack. Finally, from the top, another section goes to another roof nearly opposite. These several parts of the aerial are of necessity at different angles to one another, and the whole presents to the eye an appearance very like to that of the hind leg of a donkey.

o o o o

The Earth.

There is no law which decrees that a donkey cannot radiate ample power with its hind legs, especially when the animal is infuriated, and so it is with this aerial, which at all times and in all seasons radiates quite well. At the commencement of the construction and experiment, it was found that great difficulty was ex-

perienced in obtaining a suitable earth, because almost the whole of the district is richly endowed with a sure foundation of primary rock. Various attempts were made, and eventually a counterpoise or earth-screen was adopted. This gave fairly satisfactory results for a time; but complaints were received to the effect that crystal strength was below normal, and further experiments with the earth-screen, together with numerous other adjustments to the transmitting gear, were carried out. The result of these was good, and no further trouble has been experienced.

o o o o

To Improve Reception.

Mr. H. Cecil Pearson, Director of the Liverpool station, made the significant remark at a meeting of the Liverpool Rotary Club that the weak point in broadcasting at present is the fact that the transmitting end is far in advance of the receiving end. The truth of this assertion is undeniable, and it was borne out at the time of the change-over of 2LO from Marconi House to Oxford Street, and again in connection with the complaints of listeners when 5XX was transferred from Chelmsford to Daventry. The B.B.C. is always willing to advise listeners as to improvements in their aerials which might be effective in improving reception; and that this advice is welcomed by a large body of listeners is shown by the many letters of thanks received subsequently from those who thought when first they made complaint, that they had a legitimate grievance against the B.B.C.

o o o o

Improvements.

In some cases listeners admitted that the system of earthing was at fault. Others have told the B.B.C. engineers

who gave them advice that their crystals were ineffective, and others have found that the unsatisfactory reception was largely a matter of headphones. The moral is: Write to *The Wireless World* if in trouble with your receiving set.

o o o o

The Hayes Station.

The B.B.C. has established at Hayes a wireless station which is quite different from any that they have established before; it is a receiving station, and it will be used for a number of purposes. The most important of these are firstly for tracking down and finding out the identity of any interference which is causing trouble to transmissions from any of the stations, and keeping an accurate check on wave-lengths.

o o o o

Relaying Foreign Programmes.

Secondly, the station will be used when relays of foreign programmes are carried out. An aerial will be erected which it will be possible to alter according to the station which it is desired to receive, and a high grade selective receiving set capable of picking up the distant station with as little accompanying "mush" and atmospheric as possible. There is no doubt that with a place where experiments can be carried out every night, after due investigation better results will be obtainable than have hitherto been possible.

o o o o

Experimental Work.

The third main use of this receiving station will be for the carrying out of experimental work of any nature which may be necessary for the improvement of the art. New ideas not specially con-

nected with broadcasting may need to be tried out, and most of this work will be done at Keston in the first place. Ideas will there be developed, and if proved to be of practical use they will be incorporated in the apparatus used at other stations.

o o o o

An Isolated Spot.

The site of the station is thirty acres in extent, and is a flat plateau several hundred feet above sea level on the borders of Kent and Surrey. Two small wooden huts have been built which provide ample room for the housing of the receiving apparatus, stores, engineers' office, and accommodation for sleeping if necessary. Another hut contains the storage battery for lighting and power purposes generally, together with the necessary charging plant. A water supply and telephone lines are, of course, available, and the site itself is one of the most isolated spots that it has been possible to find near London. The chances of local heterodyning interfering with reception experiments are very remote, as aerials in that neighbourhood are few and far between.

o o o o

The Masts.

There are at the moment two masts erected, each sixty feet high and a hundred and twenty feet apart, but these, of course, may be altered as conditions demand. The possibilities that such a station opens up are considerable, and listeners may rest assured that the engineering staff of the B.B.C. will do all they can to provide entertainment in the way of foreign programmes, and further to safeguard the programmes in a more efficient way than has been considered possible up to the present.

o o o o

ATMOSPHERICS.

"There has never been, and never will be anything static about broadcasting." The Director of the Nottingham Relay Station.

Quite so. The static comes in at the receiving end.

o o o o

The B.B.C. is said to be searching for novel noises suitable for broadcasting.

We suggest they begin with a selection of comments from a listener who is entirely satisfied with every item on every programme.

o o o o

The Mayor of Chelmsford has prepared a list of complaints from local residents "who have paid for licences and cannot hear Daventry." It is one of those unfathomable mysteries of radio that good reception is not assured by payment of a licence fee.

o o o o

Bradford educationists are complaining that the broadcast talks for schools are too entertaining. The B.B.C. are understood to possess ample facilities for remedying the fault.

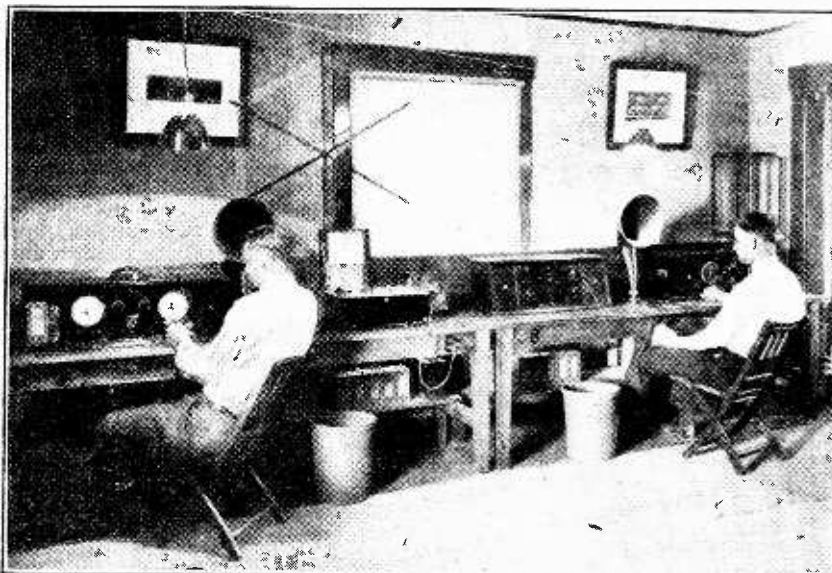

TESTING BROADCAST RECEIVERS. A view in the Sacandaga Laboratory of the General Electric Company, New York. Searching tests are here carried out on wireless receivers. Special equipment is also installed for testing loud-speakers, telephones, transformers, valves, coils, condensers, insulators and other wireless components.

SPADE TUNING.

Measurement of Eddy Current Losses.

THESE experiments were undertaken to discover what losses were likely to occur in spade tuning. The action of this form of tuning depends, as is well known, on the production of eddy currents in a metal plate in proximity to a coil. The eddy currents set up a field in opposition to that caused by the current in the coil, and so reduce its effective inductance. These eddy currents will, however, go to heat up the plate and so waste energy. The energy wasted will be proportional to the square of the eddy currents, and thus to the square of the field produced by them, and to the square of the decrease of inductance produced.

Apparatus Employed.

The circuit used for the experiments is shown in Fig. 1. The valve V_1 is an oscillator with a tuned circuit LC, and a grid condenser and leak $C_2 R_1$. Coupled to LC is another coil L_1 , tuned by a condenser C_1 . Across this circuit is connected a Moulin voltmeter employing grid current rectification. The meter G is a converted Weston relay reading up to half a milliamp, and the steady anode current is balanced out by a battery B and a high resistance X.

When the plug 4 is in the socket 1, and the plug 3 in 2, G is in the anode circuit of V_2 , and the anode circuit of V_1 is completed through 3 and 2. When 3 is in 1 and 4 in 2, G is in the oscillator plate circuit. A continuously variable non-inductive resistance R was put in series with L_1 .

R was short circuited, LC tuned to 400 metres, and $L_1 C_1$ brought to resonance. The anode currents of V_1 , and of V_2 with V_1 off and on, were noted.

A copper plate 7.8 cms. in diameter and 1.5 mm. thick was then fixed co-axially with and at a known distance from L_1 ; and $L_1 C_1$ retuned. The anode current of V_2 was noted and the plate removed. $L_1 C_1$ was retuned and R adjusted until the current returned to the

value obtained with the plate in position. This was repeated with the plate at various distances from L_1 . R is then the equivalent series resistance of the losses caused by the plate.

After each measurement the anode current of the oscillator, and of V_2 with V_1 off, were taken to ensure that no large changes in sensitivity had taken place during the measurements. As the oscillator had a grid condenser and

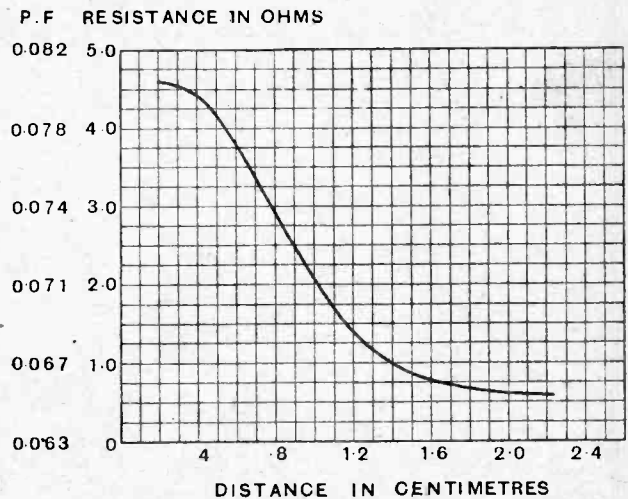

Fig. 2.—Curve giving the relationship of resistance and power factor to the distance between the metal disc and the tuning coil.

leak, its anode current is a measure of the strength of the oscillations generated by it. It was found that results could be repeated to about 1 per cent.

Results of Tests.

R was then calibrated at 400 metres in terms of some 36 S.W.G. platinum whose D.C. resistance is very nearly the same as that at 400 metres. The losses were thus obtained as an equivalent series resistance in ohms.

The values of R were then plotted against d (the distance of the plate from the end of the winding of L_1) as in Fig. 2. The resistance of L_1 was then measured at 400 metres by the resistance substitution method, and found to be 17.3 ohms. As its inductance is 58 microhenries, its reactance at 400 metres is $\frac{1885 \times 58}{400} = 273$ ohms. Thus the power factor of the coil-plate combination is given by $\frac{17.3 + R}{273}$. This is shown by the scale P.F. in Fig. 2.

Thus it is seen that on broadcasting wavelengths the power factor may be increased by over 30 per cent. by the use of spade tuning; which is certainly very much greater than that caused by a good variable condenser. These losses will also take place when screening plates are placed near coils, and will become more serious as the wavelength is reduced.

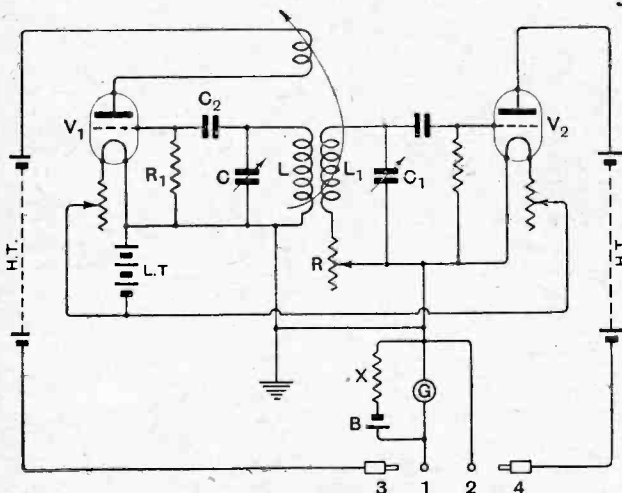
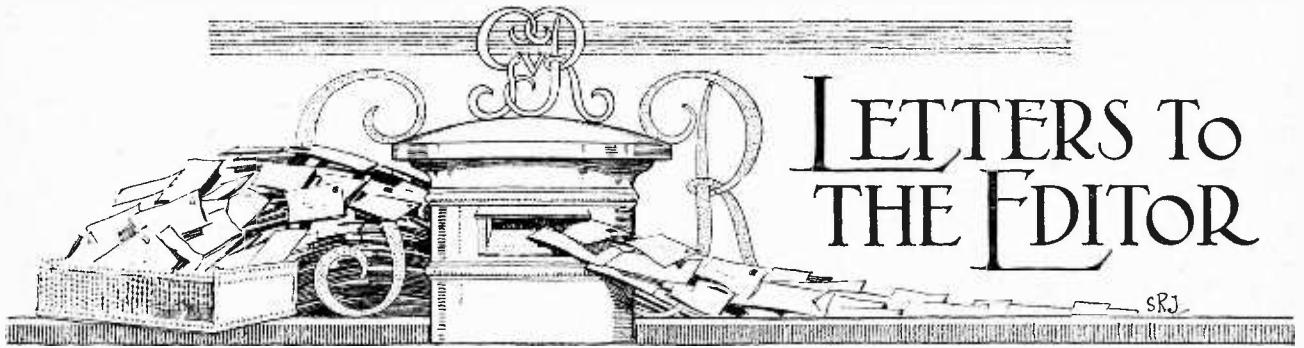

Fig. 1.—Connections of the apparatus employed in the tests.



The Editor does not hold himself responsible for the opinions of his correspondents.

Correspondence should be addressed to the Editor, "The Wireless World," 139-140, Fleet Street, E.C.4, and must be accompanied by the writer's name and address.

DIRECTIONAL RECEPTION.

Sir.—In connection with Mr. R. D. Bangay's lucid article on p. 223 of the August 19th issue, perhaps the accompanying photograph of a model made some years ago—and intended to illustrate the action shown in Mr. Bangay's Fig. 4—may be of interest. A wooden slider has its upper edge cut with a series of sine waves, and represents, when moved, the passage of the varying magnetic field past the coil. Two vertical sliders, guided by rollers, represent the positions of the vertical sides of the coil, and their arrow-heads show the value of induced E.M.F. at any moment. The resultant E.M.F. round the loop is shown by the difference in height of the arrows,

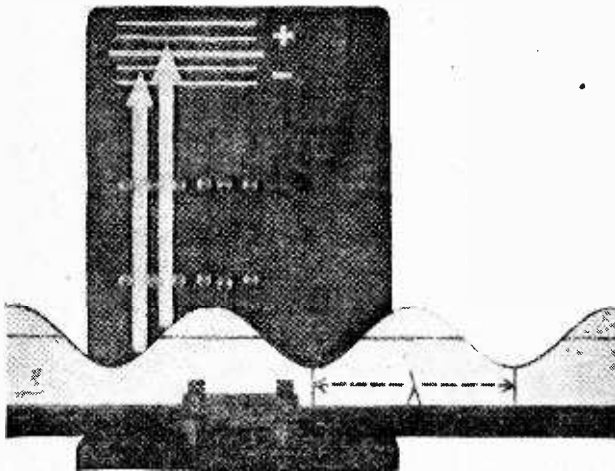

Model for demonstrating graphically the E.M.F.'s in the vertical sides of a frame aerial.

Several pairs of rollers are provided, so that the sliders may be placed at different distances apart to represent the effect of varying the coil width. Also, one slider may be placed directly in front of the other (double rollers being provided). This last position represents that of the coil with its plane at right angles to the direction of wave propagation, where the resultant E.M.F. round the coil is zero, although the full E.M.F. is still induced in the conductors forming the two sides.

This model was shown before the R.S.G.B. at a meeting in January, 1920 (see *The Wireless World* for March, 1920).
Rugby. R. C. CLINKER.

TRANSFORMER DESIGN.

Sir.—In the correspondence columns of *The Wireless World*, August 26th, Mr. A. R. Turpin raises two points which appear to be of very great importance to all amateur constructors of wireless receiving sets. It is noticeable that the firms which

manufacture L.F. transformers of both high and low ratio and give instructions for the high ratio instrument to be used in the first L.F. stage never, so far as I have been able to discover, give any logical reason whatever for their advocacy of this arrangement. Those of us who are regular readers of your valuable paper know that there are very sound reasons indeed for adopting exactly the opposite arrangement, and those who, like myself, have carried out experiments find that theory is amply confirmed in practice. Further, the makers of what are generally acknowledged to be the very finest intervalve transformers in the world indicate clearly in the data they publish that their instruments are to be chosen with due regard to the theoretical considerations you have repeatedly stated.

It is to be hoped that Mr. Turpin's letter will come to the notice of certain manufacturers, and that they will either produce some valid reasons in support of their recommendations or else acknowledge their error and as quickly as possible make amends in the obvious ways open to them to do so. It appears highly desirable that this question should be given the greatest possible amount of publicity for reasons which are obvious.

As regards the other point mentioned by Mr. Turpin, namely, that of simply reducing the size of the secondary so that the instrument may be honestly (!) described as "low ratio," it is a great pity that the name of any firm guilty of such a practice cannot be made public.

Finally, can there be any objection on the part of an honest firm to publishing in their advertisements and catalogues particulars regarding such components as L.F. transformers, chokes, telephones, loud-speakers, etc., which would really convey some useful information? At present anything of the sort seems to be very much the exception. It is very curious, on reflection, that although the veriest novice would never dream of purchasing a fixed or variable condenser without knowing its capacity as determining its suitability for a certain duty, yet thousands will buy an intervalve transformer or L.F. choke without knowing anything more definitely useful about it than the name of the maker. This is really a deplorable state of affairs, but the blame for it lies as much with the purchasing public as with the manufacturer for not supplying voluntarily what ought to be regarded as essential information.
J. H. S. FILDES.

Llandudno Junction, N. Wales.

BELGIAN AND NEW ZEALAND DX.

Sir.—We are glad to state that the first two-way working between Belgium and New Zealand has been carried out by B4YZ, who worked Z2AC on August 29th at 05.30 G.M.T. Z2AC received B4YZ, strength R5. The power at B4YZ station was 65 watts input, pure C.W. Wavelength: 45 metres.

During the test Z2AC said he had also heard B4RS, another amateur at Verviers. The input at B4RS was 45 watts, rough A.C.

R. PIROLLE,
Secretary, Radio Club Belge de l'Est.

Verviers, Belgium.

H.T. VOLTMETERS.

Sir,—There are one or two types of combined low- and high-reading voltmeters on the market which, although the advertisements do not say so, are quite unsuitable for H. T. use. The wording of these advertisements to the uninitiated would give the opposite impression, I do not suggest that this is direct misrepresentation on the manufacturers' part, but lack of forethought.

In a case I have in mind, a friend brought round a double-reading instrument which he had just purchased, and asked me to test it out. Being careful, I tried it on a bank of storage batteries, and found that on 40 volts it consumed 80 m.a., only 0.02 short of 0.1 amp.! It was incorrect by 5 per cent.

I explained to my friend that at the price he gave for it he could not expect anything else, as it was a commercial impossibility to produce a low consumption precision instrument at such a price.

To break away from this point, I agree absolutely with Mr. A. R. Turpin's remarks about transformers, which he very aptly comments on in the current issue; personally I never trust any components before I have tested them all out, and I have a fine black list of duds!

J. P. T. CHAPMAN.

Bournemouth.

Norwich.

British:—5NW, 2YO, 6RM, 5XY, 2NB, 5MS, 6YR, 2BDQ, 5MA, 2MK, 2FT, 2YQ, 2UV, 5OC, 5DK, 5CW, 2WA, 2MX, 6BT, 6YK, 2FM, 2DF, 2FK, 6VP, (all on 75-110 metres), 2NJ, 2NM, 2CC, 6RY, 5SZ, 2VR, 2XY, 5SI, 2OD, 6TD, (all on 10-45 metres). *French*:—8VAA, 8GJ, 8BN, 8Z3, 8JO, 8CC, 8AQ, 8TU, 8VO, 8NY, 8NS, 8WIN, 8RA, 8KK, 8OMA, 8LDR, 8JAB, 8TK, 8CF, 8VU, 8GVR, 8HSG (on 75-110 metres), 8KL, 8VAA, 8RA, 8QO, 8BN, 8CT, 8WA (on 18-45 metres). *Belgian*:—2Q, 4SR., G6. *German*:—I2, Y5. *Holland*:—ORO, OZA, OKG, OMS, OAAA, OPM, OMR, OKV, OCO, OBA. *Sweden*:—SMUF, 2NM, SMXU. *Denmark*:—7ZM, 7EC. *Italian*:—1BP, 1AY, 1AS, 1NO, 1MT. *U.S.A.*:—WIZ, 4SA, 1ARH, 2BB, 1NC, 2LU, 3AHA, 1AFM, 2BBX, 2CAZ, 1UW, 9BB, 8APO, 4OA, 4SA, 4KT, 2XBB, 1AX, 2XAF, 8MAQ, 3AEW, 3AA (on 18-45 metres). *Australian*:—3BD. *Unknown*:—B9, 7E, 5IGG, HLB, 1AM, RDV, CHR.

H. J. HAMPSON (G6JV).

Braintree.

American:—4ASK, 4KT, 4OI, 4VL, 5AIL, 5KK, 5LH, 8ADM, 8BPL, 8CCQ, 8CJP, 8CMX, 8DA, 8DAE, 8DKQ, 8EQ, 8ER, 8JQ, 8RP, 8SF, 8TX, 9CXX, 9EK, 9FF, 9MM, 9MN, 9UQ, 9XS. *New Zealand*:—2AC, 2AE, 2SP, 2XA, 4AG, 4AK, 4AL. *Australia*:—2CM, 2YI, 3BD, 3BQ, 3EF. *Argentina*:—CB8, BA1. *India*:—7XX. *Algeria*:—8ALG. *Brazil*:—1AB. *Russia*:—RDW. *Mexico*:—1AA, 1N. *Porto Rico*:—4SA. *Mesopotamia*:—1DH. *Czecho-Slovakia*:—OK1.

(0-v-1.) (All below 40 metres.)

D. Woods (G-2ANX).

Burnley, Lancs.

(July 25rd—August 2nd.)
America:—WAP, WIR, WIZ, WSC, WQN, NKF, 1ABP, 1ACI, 1AEP, 1AHG, 1AN, 1ANA, 1APG, 1ARE, 1ARH, 1AXL, 1BBW, 1BXX, 1CMF, 1CMP, 1CPA, 1CY, 1EG, 1GML, 1MK, 1MY, 1PL, 1TH, 1THG, 1TUF, 1UW, 1XAM, 2AEY, 2AGB, 2AIF, 2APN,

A SOUTH AFRICAN AMATEUR.

Sir,—As I have seen no mention of late of reception of South African amateurs, you may be interested to hear that I heard OAAZ calling A2CM at 10.15 p.m. G.M.T. on August 21st. He was working on 35 metres and his signals were quite steady at about R4.5.

A. SIMONS.

Mablethorpe, Lincs.

A SELENIUM GRID LEAK.

Sir,—I read with interest the article by Mr. G. G. Blake on selenium grid leaks in your issue of August 26th.

It may interest readers to know that I designed a grid leak on this principle as far back as May, 1924, and approached an important London firm on the matter.

I described the grid leak in a letter on October 3rd, 1924, pointing out its particular use with the Flewelling circuit, using the valve as a source of illumination for both leaks.

The idea occurred to me when reading an article by Mr. P. R. Coursey on "Selenium and Its Uses" in the issue of *The Wireless World* of May 29th, 1920.

Mapperley, Notts.

G. H. ATKIN.

Calls Heard.

Extracts from Readers' Logs.

2BB, 2BEE, 2BUY, 2BYW, 2CYW, 2GK, 2WC, 3AF, 3AHA, 3JA, 3JS, 3JW, 4ASK, 4FM, 4RAI, 4RL, 8BME, 8XS, 9DQU. *France*:—8AAA, 8AG, 8BN, 8CO, 8CT, 8EE, 8FQ, 8HSF, 8JAB, 8NTA, 8OK, 8RA, 8RDI, 8TOK, 8QQ, 8WAG, 8ZA, YZ. *Britain*:—2LZ, 2VX, 2ZG, 5DH, 5LF, 5LS, 5NJ, 6AH, 6RM, 6RW, 6TD. *Miscellaneous*:—CZ2SP, Y1XX, 11AS, 11AE, 11MT, MIDH, DIEC, PR4RL, B4RS, BB7, BE2, BZ1, BR2, EAC9, EAC17, 2YT, 3CA, AGA, HVA, POF, POX, POY, RDV, RCRL, SMXU, OCDJ.

(20-120 metres.) J. MURCUTT.

Glasgow.

Great Britain:—2LZ, 2VX, 2NM, 2KF, 2DX, 2SZ, 2JN, 2NJ, 2VO, 2MC, 2XY, 5HX, 5LF, 5NJ, 5RZ, 6TD, 6AH, 6QB, 6RH, 6KK, 6TM, 6GB. *French*:—8SW, 8BN, 8ALG, 8CZI, 8TOK, 8CO, 8QQ, 8EE, 8BF, 8FQ, 8VAA, 8AG, 8BA, 8AQ, 8HN, 8NDI, 8CZ, 8CN, 8WAG, 8CT. *Dutch*:—OBA, OHB, OSV, OSK, PCUU, PCMM. *Belgian*:—8X, P7, H6. *Italian*:—1AS, 1RG, 1MT, 1AT. *Mosul*:—1DH. *Indian*:—Y7XX. *Java*:—ANE. *Various*:—3CA, 7AR, AGA, POF, POW, POX, BSM. (All below 50 metres.)

(0-v-0 Reinartz.) A. T. WILSON.

Bishopston, Bristol.

British:—2AB, 2BP, 2JB, 2KI, 2KW, 2LZ, 2PF, 2PP, 5CT, 5HX, 5NS, 5PW, 5RQ (?—almost unreadable), 6MP, 6QB, 6QM, 6RY, 6RM, 6TM, 6VP, 6YQ. *French*:—8AL, 8ALG, 8BN, 8BF, 8BP, 8CAX, 8CQ, 8CT, 8EE, 8EN, 8JB, 8JAB, 8JD, 8KE, 8KK, 8KZ, 8LDR, 8LM, 8LP, 8MS, 8NA, 8NY, 8OMA, 8PKX, 8PR, 8RC, 8RE, 8RRR, 8RY, 8SU, 8TK, 8TOK,

8TI, 8TR, 8TVI, 8UDI, 8VU, 8ZZ. *Dutch*:—OAAA, OBA, OCDB, OCDJ, OCDV, OGM, OKG, OMS, ONR, OPM, ORO, OXX, OZM, PCMM, PCUU, 2PZ. *American*:—1ANI, 1BTR, 1CAU, 1CK, 1CKP, 1CKX, 1CMX, 1DGM, 1EL, 1ER, 1EN, 1KP, 1MK, 1MY, 1NC, 1OS, 1PL, 1PO, 1UW, 1VP, 1XF, 2AAO, 2AC, 2AFN, 2AGB, 2AI, 2AN, 2BRB, 2BO, 2BX, 2DD, 2DY, 2GK, 2GU, 2LJ, 2MW, 2MU, 2NO, 2NR, 2PL, 2RL, 2WC, 3ASL, 3DU, 3MS, 3WA, 4AAE, 4AF, 4AS, 4AV, 4BT, 4CP, 4CK, 4FM, 4IE, 4JA, 4KP, 4KQ, 4MD, 4RC, 4TA, 4TV, 4UK, 4VL, 4XE, 5AG, 5BJ, 5CI, 5IS, 5RSR, 5IW, 5WNW, 5WV, 6AC, 6CG, 6CN, 6CT, 6FG, 7VU, 7WI, 8KS, 8NG, 9BEK, 9CF, 9EE, 9FS, 9RR. *Miscellaneous*:—CB8, XOX, C1AR, SMYY, HVA, ANE, BSM, BSR, T7XX, 7RM, 7US, 7AR, 7VS, 1AF, CHR, PKX, EAR1, EAR3, EAR7, CPKX, RCRL, RER, KIZ, PCG, BZ2SP, NKF.

J. MONCKTON (G2BAZ).

Harrow.

(July 26th to August 23rd.)
Australian:—2CM, 2YI, 3BD, 3BQ, 3EF. *New Zealand*:—1AA, 2AC, 2AE, 2AQ, 2XA, 4AG, 4AR. *Chile*:—1EG, 2LD. *Argentine*:—A8, BA1, CB8. *Brazil*:—1AB, 1AF, 2SP. *Mexico*:—1B, 1K, 9A, 1AA, 1AF. *Pacific Ocean*:—NRRL, NUMM. *Greenland*:—WAP. *Porto Rico*:—4OI, 4RL.

(0-v-1.) (About 40 metres.)
F. C. AND I. A. STUDLEY.

Guildford.

(August 27th and 28th.)
British:—2DX, 2VX, 5DH, 5IG, 6GH, 6TD, 6ZD. *French*:—8HLL, 8RIC, 8AOA, 2R, 8AL, 8JN, 8BF, 8CNX, 3CA, 8KL, 8APA, 8NB, 8SSI, 8VU, 8DGS, 8WAG, 8TU. *Dutch*:—OZA, OGG, ORO, OAG, 2PZ, OCO, OAW, OAM, OREN. *Swedish*:—SMUU, SMUV, SMYY. *Italian*:—1AS, 1BS, 1GN, 1RT. *Finnish*:—1NS, 2NS. *American*:—1AAO, WIR, 4WQN, WAI.

(0-v-1.) (On 30 to 92 metres.)

H. E. F. TAYLOR.

Readers Problems

Readers Desiring to Consult "The Wireless World" Information Dept. should make use of the Coupon to be found in the Advertisement Pages.

Problems of Selectivity.

A READER who resides in fairly close proximity to a broadcasting station wishes to construct a receiver which will enable him to receive other B.B.C. stations at the same time that his local station is working without resorting to the use of a superheterodyne receiver and a frame aerial.

Although, of course, a superheterodyne receiver is undoubtedly the best receiver to employ under these conditions, it is by no means the only circuit which can be employed, and unless the receiver is in exceptionally close proximity to a powerful transmitter, it is possible to arrange a suitable circuit without employing a large number of valves. The use of a well-constructed neutrodyne set employing two H.F. stages is one solution of the problem, since if it is correctly designed the two tuned H.F. stages in conjunction with the aerial tuning system give a very high degree of selectivity. If desired, selectivity can be still further increased by making use of a loosely coupled aerial system, since the receiver will not be rendered unstable by the addition of this if the stray capacities are properly neutralised. A receiver of this type unfortunately requires rather a large number of valves. An ordinary conventional four-valve set will provide a good degree of selectivity if properly designed, but the use of loose coupling with a set of this type is apt to render it unstable and difficult to handle. It is often possible considerably to improve the selectivity of a receiver of this description by mounting all three coils, aerial, anode and reaction, on a three-way coil holder, thus obtaining a double-reaction effect. In this manner a very critical control of reaction and, therefore, of selectivity may be obtained. The aerial coil should be mounted in the middle and the anode coil should be connected so that it gives a negative reaction effect, positive reaction being applied by the ordinary reaction coil in the usual manner. Even this method, however, leaves much to be desired. There are, of course, several forms of wave trap circuits available, but many of them are troublesome and not worth the trouble of their operation. It cannot be denied that loose coupling when it is practicable to use it gives results superior to the use of the conventional type of wave trap. It is advised, therefore, that readers who are situated in unpleasant proximity to their local station should make use of a single valve receiver using loose coupling with, of course, an L.F. amplifier for loud

speaker work. It is quite a mistake to suppose that H.F. amplification is a *sine qua non* for the reception of other stations to the exclusion of the local one, although, of course, readers who construct a receiver of this type can assure themselves of extra sensitivity.

Frame Aerial Reception.

DURING the summer months it would be very convenient to have some means of converting a standard broadcast receiver for use with a frame aerial. In most receivers the aerial coil can be removed and replaced by the frame aerial, but there are a few types in which the aerial coil is built permanently into the set.

It is by no means an easy matter to employ a frame aerial in conjunction with this type of receiver. Probably the best method of accomplishing this is to add a stage of H.F. since this will not only have

cient both for the ordinary B.B.C. and higher wavelengths up to 4,000 metres.

Of course, if desired, the frame aerial may be removed and an ordinary plug-in coil connected across the frame tuning condenser, thus rendering the unit suitable for attaching to an ordinary aerial and earth system.

Resistance Coupling in "Intermediate" Amplifiers.

IT is not generally understood why the difficulty of matching the various intermediate amplification stages in a superheterodyne receiver is not overcome by employing a tuned transformer or tuned anode in the first or "filter" stage, the remaining stages being resistance coupled, since he points out that the wavelength of the intermediate stage is well above the lower limit of efficiency, which is usually regarded as 1,000 metres for this type of coupling.

In the first place, it may be mentioned that if the cartridge type of anode resistance is employed in order to reduce capacity losses to a minimum, parasitic noises may develop. These are due to minute changes in the resistance brought about by the passage of the steady anode current. We can get over the difficulty by employing wire-wound anode resistances, but it must be remembered that the self-capacity of these components is very much greater than in the case of the grid leak type; but in any case it is very undesirable to employ resistance coupling owing to the very low amplification per stage obtained with this method. Readers are apt to fall into the error of thinking that resistance coupling is perfectly efficient and equal to a tuned circuit on wavelengths exceeding 1,000 metres, whilst being of less efficiency below that wavelength. Actually, however, it may be said that resistance coupling is quite useless for all practical purposes below 1,000 metres, whilst above that wavelength its utility is strictly limited until audio frequencies are reached. In the case of the B.B.C. wavelengths we are dealing with frequencies in the neighbourhood of a million per second, whilst on wavelengths between 1,000 and 3,000 we calculate frequencies in hundreds of thousands. Now even at audible frequencies in the neighbourhood of 1,000 per second the inefficiency of resistance coupling is such that three stages do not give the same volume as two transformer or choke coupled stages, and therefore great efficiency cannot be expected on frequencies between 30 and 90 thousand cycles.

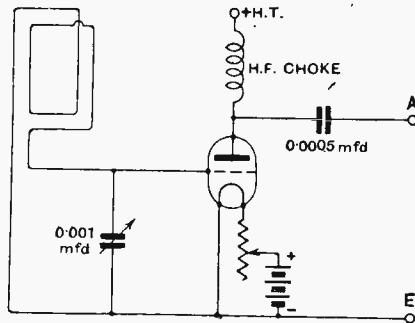

Fig. 1.—Connections of unit necessary to adapt ordinary receiver for use with a frame aerial.

the effect of rendering the use of a frame aerial practicable, but the extra H.F. valve will add the sensitivity necessary to compensate for the loss of the ordinary aerial and earth system, and will make distant reception with the frame aerial really possible. Undoubtedly the most convenient method of adding a stage of H.F. is that shown in Fig. 1. It will be seen that the connections are perfectly simple, the A and E terminals of the receiver being merely coupled across to the terminals marked A and E in our diagram. The unit can be added to any type of existing receiver, and there is, of course, no need to carry out any alterations in the wiring of the aerial circuit.

With regard to the value of the H.F. choke coil, a suitable instrument for this circuit can now be obtained from advertisers in this journal which is quite effi-

The Wireless World

AND RADIO REVIEW

No. 318.

WEDNESDAY, SEPTEMBER 16TH, 1925.

VOL. XVII. No. 12.

Assistant Editor:
F. H. HAYNES.

Editor:
HUGH S. POCOCK.

Assistant Editor:
W. JAMES.

Editorial Offices: 139-40, FLEET STREET, LONDON, E.C.4

Telephone: City 4011 (3 lines).

Advertising and Publishing Offices: DORSET HOUSE, TUDOR STREET, LONDON, E.C.4.

Telephone: City 2847 (13 lines).

Telegrams: "Ethaworld, Fleet, London."

COVENTRY: Hertford Street.

BIRMINGHAM: Guildhall Buildings, Navigation Street.

MANCHESTER: 199, Deansgate.

Telegrams: "Cyclist Coventry."
Telephone: 10 Coventry.

Telegrams: "Autopress, Birmingham."
Telephone: 2970 and 2971 Midland.

Telegrams: "Hiffe, Manchester."
Telephone: 8970 and 8971 City.

Subscription Rates: Home, £1 1s. 8d.; Canada, £1 1s. 8d.; other countries abroad, £1 3s. 10d. per annum.

As many of the circuits and apparatus described in these pages are covered by patents, readers are advised, before making use of them, to satisfy themselves that they would not be infringing patents.

THE WIRELESS SHOW.

WIRELESS is still a new industry, and the design of apparatus associated with broadcast reception is passing through a stage of evolution. The steady development which is going on is not entirely the outcome of invention, but is more probably due to the stabilising of an industry and the establishment of an improved manufacturing organisation. It may be said that the manufacturer and the wireless enthusiast have rivalled each other in an endeavour to construct equipments possessing good selectivity, an extensive receiving range, with easy manipulation and the elimination of distortion. It must be admitted that a peculiar position has existed where prospective purchasers would exercise caution and seek advice before selecting a receiving set, and exhibit a hesitancy that would indicate a lack of confidence in the manufacturer. The exhibition this year indicates that a change has come about and that the wireless trade is now taking a lead. It is now possible to select a broadcast receiving set built to a design that will not be rapidly superseded and with which the user will remain satisfied in spite of his technical interest in receiver design.

Superheterodyne sets now find a place among broadcast receivers, and considerable interest is shown in the several models to be seen probably as a result of the popularity attained by this type of set during the past few months. Another development is the entirely self-contained set obviating the connecting up of a number

of units. Very little advance appears to have been made towards providing easy manipulation, and, in general, manufacturers do not appear to be concerned as to the number of dials appearing on the face of an instrument. Most of the circuits employed can be described as "straight," and the number of reflexed sets offered is on

the decline. There is an increase in the adoption of plug-in units for tuning purposes, and many sets intended for broadcast reception can be tuned to receive on wavelengths as low as 40 metres. The array of valves is ever increasing, which is a step in the right direction, provided that literature is available describing the applications of the many different types. Several new types of secondary batteries have been developed for H.T. supply, and, in view of the small discharge rate, cells capable of holding a charge for a period of six months will no doubt substitute the dry cell type battery for the operation of multi-valve sets. The convenience of public supply mains as a source of current for receiver operation has not been overlooked, and there is an indication that before very long, with the aid of specially designed valves, it may be possible to plug in on the public supply to obtain both fila-

ment heating and plate current. Among the new components are variable condensers, intervalve transformers, and parts for superheterodyne receiver construction. Instrument dials operating through reduction gear suitable for fitting to condenser spindles now appear on the British market for the first time, and with their introduction it is probable that the threaded spindles at one time so generally adopted in low-price condensers will disappear.

CONTENTS.

	PAGE
EDITORIAL VIEWS	341
FOUR VALVE QUALITY RECEIVER. ...	342
By W. James.	
THE WIRELESS LIGHTHOUSE ...	348
NOVELTIES FROM OUR READERS ...	351
CURRENT TOPICS	353
AROUND THE STANDS AT THE WIRELESS EXHIBITION	355
EXPERIMENTAL VALVE UNIT... ..	361
By G. G. Blake.	
COMPACT DETECTOR AND NOTE MAGNIFIER	363
By F. Van Neck.	
BROADCAST BREVITIES	367
H.F. AMPLIFIER DESIGN	369
By G. W. Sutton.	
RECENT INVENTIONS	372
A NEW SYSTEM OF SHORT WAVE TRANSMISSION	373
By E. F. W. Alexanderson.	
LETTERS TO THE EDITOR	375
READERS' PROBLEMS	377

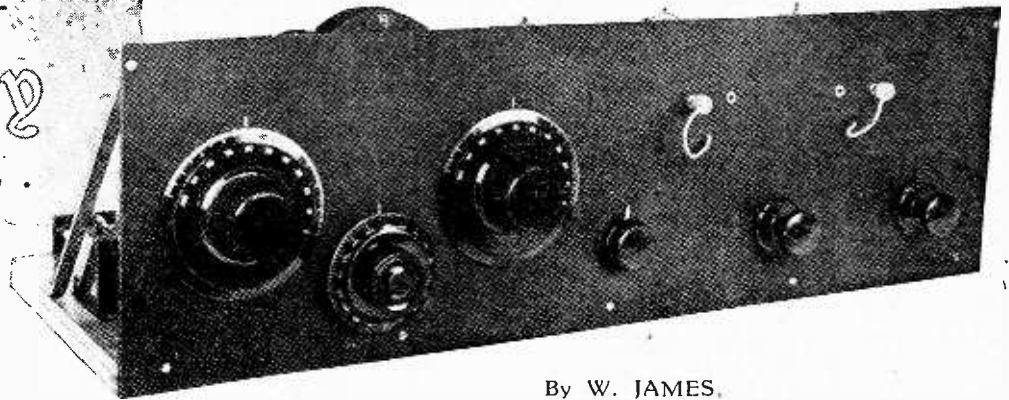

By W. JAMES.

SEE SPECIAL LARGE WIRING DIAGRAM SUPPLEMENT.

The Design and Operation of a Broadcast Receiver for Loud-Speaker Work.

IT would appear that wireless listeners are beginning to appreciate the difference between the really good quality of reproduction it is possible to get with a carefully designed receiver and the more usual indifferent results obtained from a set arranged without proper regard to the natural limits of valves and intervalve couplings. Listeners are realising that distortionless magnification can only be obtained by the use of properly designed couplings and suitable valves, so that while a short time ago it was a common thing to see a loud-speaker working from a set with reaction pushed to the limit, with general-purpose or low-power valves and with inadequate grid and plate voltages, it is now found that greater attention is being given to these points in an endeavour to make the reception as perfect as possible by the use of suitable valves and intervalve couplings.

The distortion set up by ordinary receiving sets is usually due to:—

- (1) The grid condenser and leak method of detection.
- (2) The use of an audio-frequency amplifier with a poor frequency characteristic.
- (3) Working beyond the linear portion of the valves grid-volts, plate-current characteristic, by using wrong valves and unsuitable grid and plate voltages, and, to some extent, filament heating current.
- (4) The use of too slowly damped tuning circuits.

Removing Distortion.

Detection.—The grid condenser and leak method of detection is commonly used because it is more sensitive to weak signals than other rectifiers, but it distorts because the impedance of the grid circuit changes with the amplitude of the signal. The distortion can be reduced by employing a low value of grid leak, but, as this has the effect of weakening the signals, the method is not satisfactory. It is better to remove the grid condenser and leak and to use the valve as an anode rectifier, even though this type of rectifier is relatively insensitive to weak signals.

The efficiency of the detector can be considerably improved and practically distortionless rectification be obtained by increasing the amplitude of the high frequency currents before applying them to the rectifier. We may provide a local source of high frequency currents of the same wavelength as the incoming signal, or, what is more practical, employ a stage of H.F. magnification. Then,

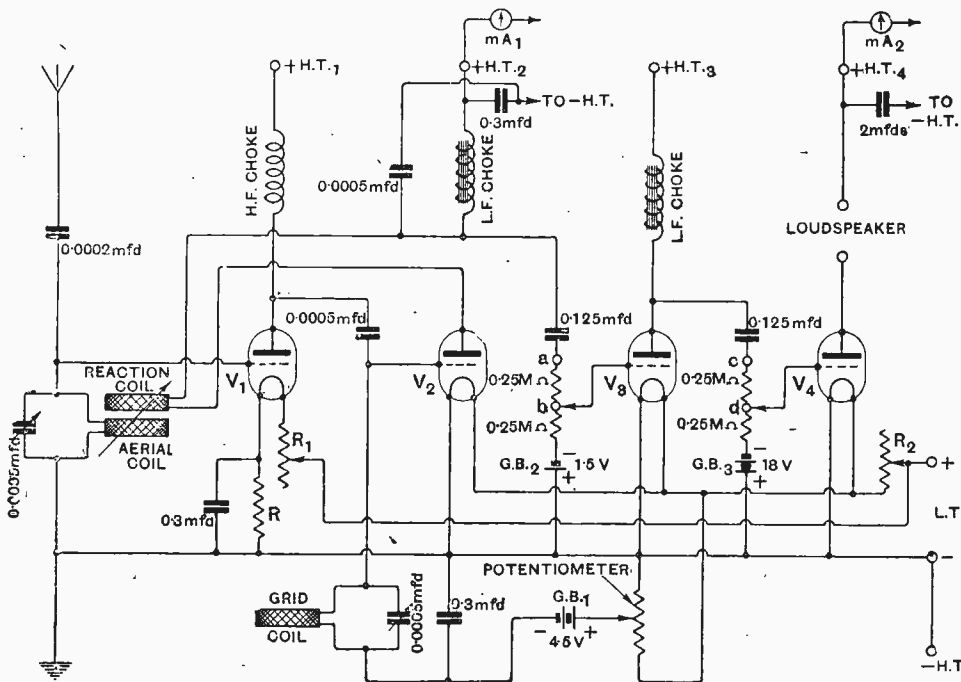

Fig. 1.—Schematic connections of receiver.

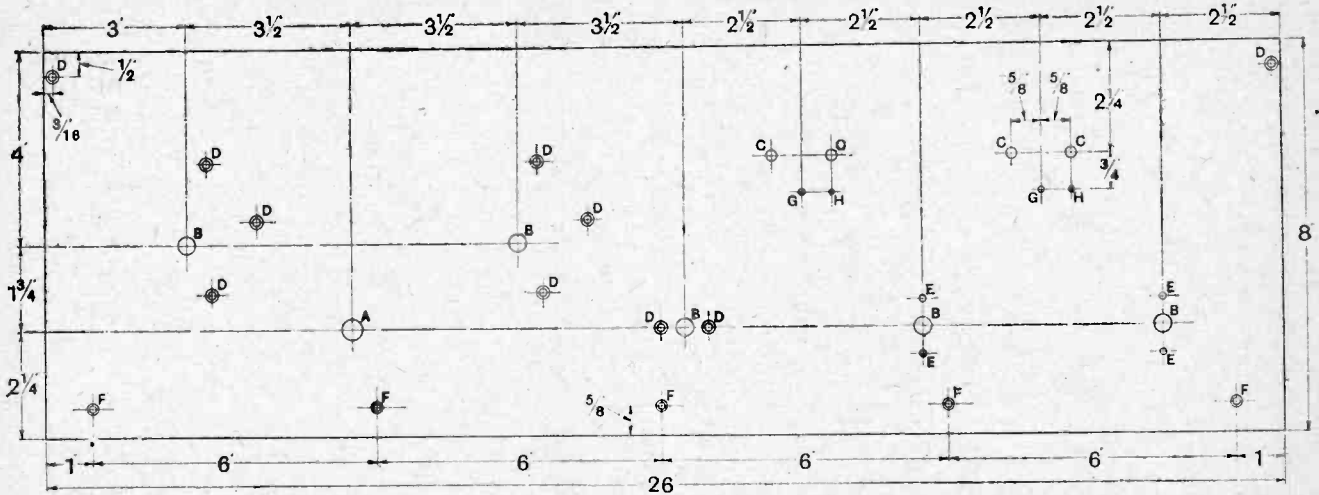

Fig. 2.—The front ebonite panel. Details of securing and clearing holes. A, 7/16in.; B, 3/8in.; C, 7/32in.; D, 5/32in., and countersunk for No. 4 B.A.; E, 5/32in.; F, 1/8in., and countersunk for No. 4 wood screws; G, 1/8in.; H, 3/32in., 3/16in. deep, tapped 6 B.A.

with the normal broadcast transmissions, rectification will take place on the straight part of the grid-volts, plate-current characteristic when receiving relatively strong signals, such as those from Daventry or the local broadcast station.

The L.F. Coupling.—There is no doubt that the transformer method of coupling is best provided the amplification-frequency characteristic of the complete magnifier is good, but such poor results are obtained by taking *this* valve and *that* transformer and joining them together, that transformer coupling is best left alone unless one is prepared to go to the trouble and expense of using transformers and valves which are designed to work together and have a guaranteed performance curve. Only a few manufacturers have the skill to construct desirable transformers; the majority of transformers are badly made and wrongly described, and often their makers withhold essential information from purchasers. For instance, it is found that certain makers market a range of transformers of different ratios, the primary windings being the same in each model, while the number of turns on the secondary is varied to give the different turns ratio—a senseless thing to do, which will have the effect, moreover, of turning people against this form of coupling. It is principally due to this state

of affairs that transformer coupling is not used in the receiver described below. Instead, choke coupling is employed. This form of coupling is a very good one provided chokes of big inductance are used with suitable valves. The disadvantage of the method lies in the grid condensers and leaks; these components are quite cheap, however, and when the correct valves are used, with the proper grid and plate voltages, distortionless amplification can be obtained.

The Valves.—Unfortunately, there are many valves on the market which are hardly suitable for audio magnifiers unless very high plate voltages are used. Thus it follows that, although the makers' instructions as to the correct grid and plate voltages are carried out, the voltages applied to the last valve of the magnifier, which supplies the loud-speaker, are altogether too great for that valve to handle. The last valve of a magnifier is for the purpose of turning volts into power to operate the loud-speaker. Hence this valve should be one having a very low impedance.

It is generally agreed that 12 to 18 volts (that is, 24 to 36 volts swing) should be applied to the grid of the last valve for good loud-speaker results, so that this valve should be given a grid bias of 18 volts and a correspondingly high plate voltage. For a M.O. D.E. 5a, a plate voltage of 120 is suitable when the grid bias is negative 14 volts, or 140 volts for negative 18. The normal plate current will then be 13 or 14 milli-amperes, the amplification factor of the valve 3.5, and its impedance 4,000 ohms. A better valve is the L.S. 5a, which, with a grid bias of negative 18, should have a plate voltage of 130, and has then an amplification factor of 2.5 and an impedance of 2,750 ohms. This subject of valves is an all-important

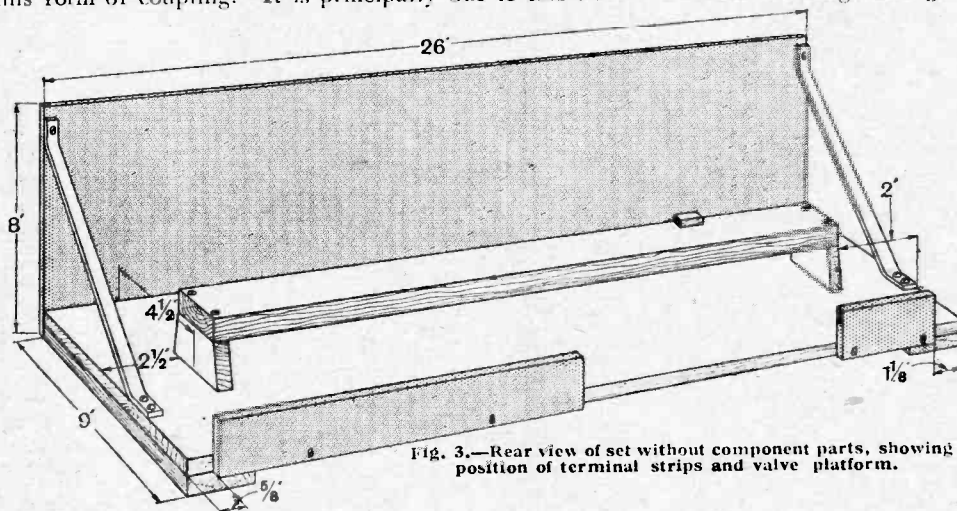

Fig. 3.—Rear view of set without component parts, showing position of terminal strips and valve platform.

Four Valve Quality Receiver.—

one—so few people use a sufficiently large grid bias and a valve designed to take it.

It is to be understood, of course, that grid current is not to be tolerated in any part of the set, and this condition can only be obtained by using a sufficiently large grid bias and plate voltage.

H.F. Circuits.—Noticeable distortion is not usually produced by tuned H.F. circuits unless reaction—intentional or otherwise—is applied to such an extent that the

set is not far off the oscillating point. It is best so to design a receiver that, for the reception of Daventry and the local B.B.C. station, reaction is not required. It is, however, useful to include means for producing reaction effects in the set for use when receiving distant stations, as good quality is then not the first consideration.

Theoretical Connections of the Set.

The theoretical connections of the set are given in Fig. 1. It will be seen that four valves are used: V_1 being a high frequency amplifier, V_2 the anode detector, V_3 an audio frequency magnifier (used as far as possible as a voltage magnifier) and V_4 the power valve whose function is to convert the voltages applied to its grid into power for working the loud-speaker.

In the aerial circuit is a series fixed condenser, of 0.0002 mfd., and a parallel circuit comprising the 0.0005 mfd. variable condenser and the aerial coil. This combination of condensers gives good selectivity.

Connected to the aerial coil is the grid of the first valve V_1 . It is intended that a valve of the 06 L.F. class be used as V_1 , while 6 volt valves are used as V_2 , V_3 and V_4 . A fixed resistor R, shunted by a 0.3 mfd. condenser, is, therefore, included in the filament circuit along with the usual 30 ohms rheostat R_1 . Resistor R is in the negative side of the filament; therefore, the grid

of V_1 is biased negatively by the voltage drop in the resistor. Assuming that the filament current is normally 60 milliamperes, the voltage drop across R is 0.06×26 or about 1.6 volts (R being 26 ohms), and the grid of V_1 is, therefore, biased 1.6 volts negatively.

In the plate circuit of V_1 is a choke coil, the choke (Cosmos radio choke) being of the type which has a self-capacity of only 3 or 4 microfarads and a very large inductance. Connected between the plate of V_1 and grid of V_2 is a stopping condenser of 0.0005 mfd., while between the grid of V_2 and the grid battery, GB_1 , is a tuned circuit comprising the grid coil and 0.0005 mfd. tuning condenser.

Thus it will be seen that the normal potential of the grid of the detector valve V_2 is fixed by the 4.5 volt battery, GB_1 , and the position of the sliding contact of the potentiometer. When the contact is at the negative side of the potentiometer, the grid is negative by 4.5 volts. This is the usual operating condition. The potentiometer and grid battery are shunted by a large fixed condenser (0.3 mfd.).

This is a rather peculiar circuit arrangement, but it is a thoroughly effective one. A usual way of viewing its operation is to consider the incoming signals to be magnified by the valve and H.F. choke, while the tuned grid circuit acts as what is popularly termed a "wave trap," this circuit being carefully tuned to the signals. The signals, therefore, create voltages across the tuned grid circuit, which are rectified by the valve, and, should signals of different wavelength be present, these are shunted to the filament circuit, and do not build up voltages across the circuit. Such an arrangement gives a surprising degree of H.F. amplification, and, as explained above, this H.F. magnification, especially in the case of weaker signals, causes the rectifier to operate efficiently, and, by carrying the signals over the bend of the grid-volts plate-current curve of the rectifier minimises distortion.

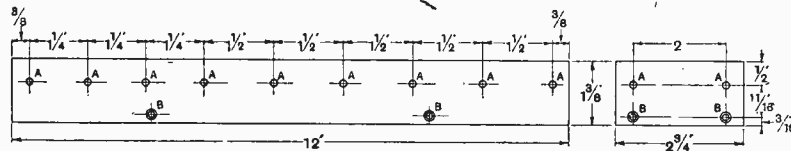
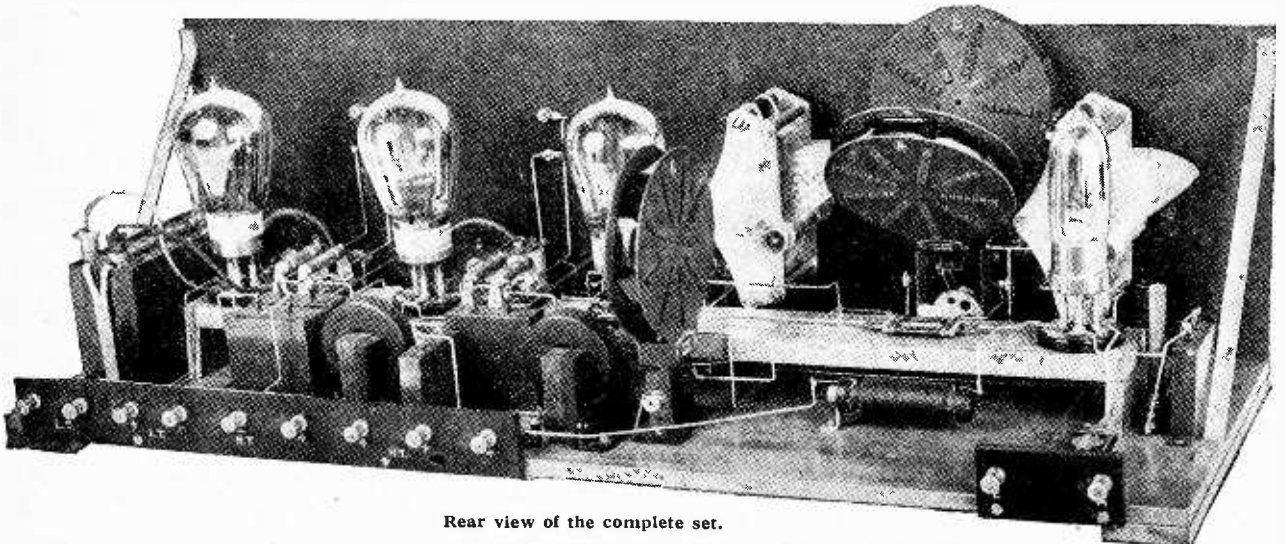
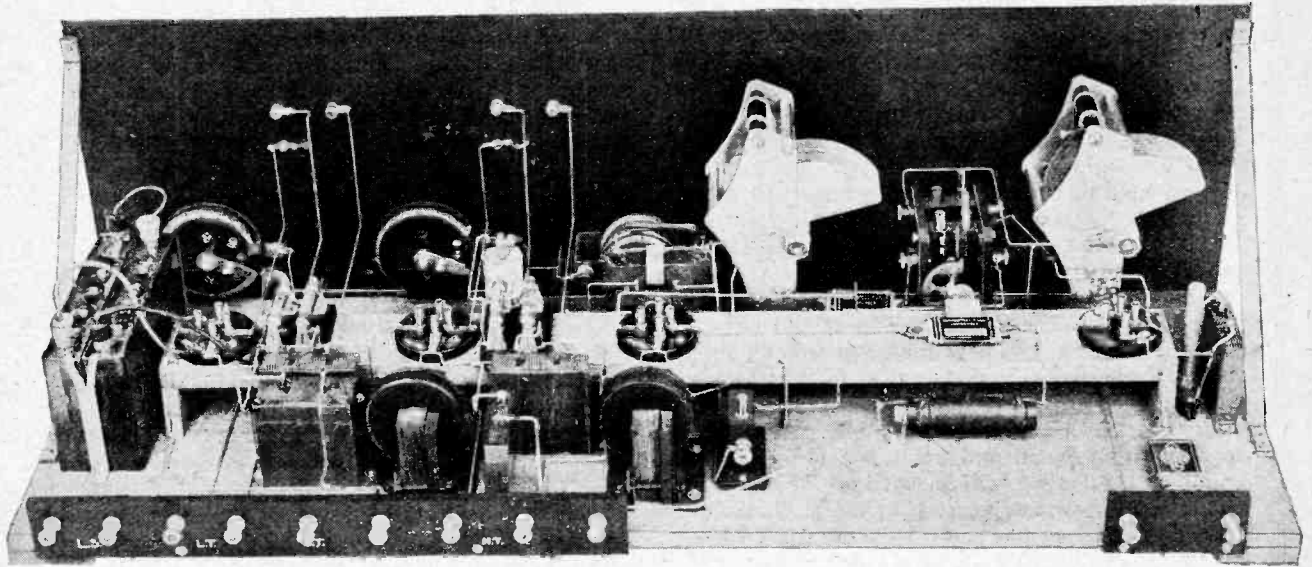

Fig. 4.—The ebonite terminal strips. A, 5/32in. B, 1/8in., countersunk for No. 4 wood screws. The strip is 5/16in. thick.



Rear view of the complete set.



Another view which shows most of the wiring. It should be noticed that the series aerial fixed condenser and the coupling condenser between the first and second valves are held by the wiring.

It is not necessary to use the stage of H.F. when receiving, for example, the London station at a place five miles from 2L.O, but the H.F. is used when receiving Daventry or any station other than the local one. To cut out the stage of H.F., it is only necessary to turn off the filament resistance R_1 . Then the incoming signals applied to the grid of V_1 pass through the capacity between the grid and plate of the valve, through the 0.0005 mfd. stopping condenser, to the grid of the detector. Incidentally, with such a low effective coupling capacity between the aerial and rectifier, the tuning of the grid circuit is considerably sharpened.

In the plate circuit of the detector is the reaction coil and shunted L.F. choke. As explained above, the reaction coil is not used except when receiving distant stations, and then a small coil should be employed as with anode rectification some slight skill is necessary before the peculiarities of the circuit can be mastered.

The choke (Pye or Success) is shunted with a 0.0005 mfd. condenser which is connected between the top of the reaction coil and negative H.T., and its function is to carry the radio frequency component of the rectified current direct to the filament. It serves to keep the H.F. currents out of the L.F. amplifier.

Valve V_2 should be a power valve—a B.T.H. B₄, Mullard D.F.A.O., or M.O. D.E.5, the general characteristics of these valves being filament volts 5.5, filament current 0.25 ampere, amplification factor 7, and impedance 6,000 ohms at zero grid volts. A plate voltage of 45 will normally be used. The L.F. choke may have the same characteristics as the one connected in the plate circuit of V_3 . Its inductance should be very high—100 or preferably 150 henries—and its core and winding should be of liberal cross-sections.

With the components described we may be certain that an incoming signal is producing undistorted volts across

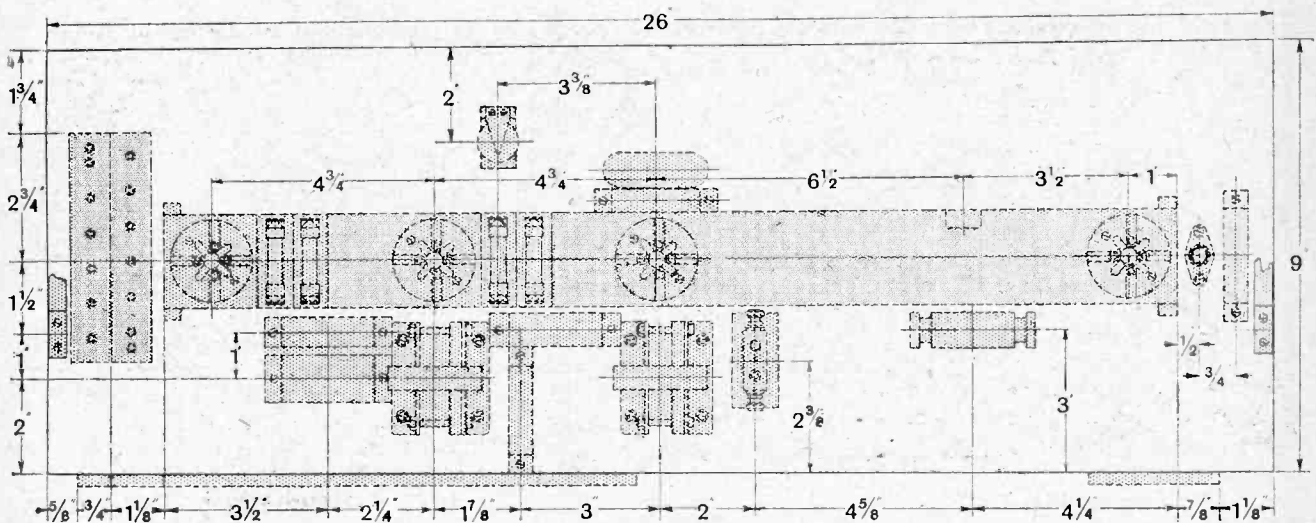

Fig. 5.—Plan of the parts assembled on the baseboard.

Four Valve Quality Receiver.—

the choke connected to V_2 . The fluctuations of potential are now applied to the grid of the audio-frequency magnifier V_3 through the 0.125 mfd. stopping condenser. This condenser should be one having a high value of insulation resistance; to make quite sure of this, it would be preferable to employ a mica condenser, but extensive enquiries revealed that no large manufacturer will supply them at present. A Mansbridge type of condenser, which has a paper dielectric, was therefore used, and is, indeed, perfectly satisfactory.

To fix the normal potential of the grid of V_3 at a suitable value, a grid leak and grid battery should be used. It is desirable, however, to have some means for altering the volume by reducing the volts applied to V_3 ; therefore two 0.25 megohm grid leaks are used as indicated, and the grid of V_3 may be connected to points *a* or *b*, point *a* giving the full volume, and point *b* a lower volume. The grid bias GB_2 is 1.5 volts negative. This valve is of the high amplification type, such as the M.O. D.E.5*b* or Mullard D.F.A.4, the general characteristics being filament volts 5.5, filament current 0.25 ampere, plate volts 120 with grid at negative 1.5 volts, amplification factor 20, and, under the working conditions, an impedance of 30,000 ohms.

Valve V_3 is coupled to V_4 by a second choke and coupling condenser, and the voltage applied to the grid

are secured to a raised platform. The terminals are all arranged on a strip of ebonite screwed to the back edge of the base board. With this general arrangement the connecting wires are particularly short and are easily wired in a neat and orderly position. The raised valve platform is a great help from the point of view of easy wiring, while it shortens the connecting wires considerably, allowing the grid and plate wires to run in direct paths and the filament wires to be laid on or near the surface of the base board.

Constructing the Set.

The front panel is of ebonite, measuring 26in. \times 8in. \times $\frac{5}{16}$ in., and should preferably be purchased as a finished panel with edges true and matt or polished surface. On the front panel is mounted the two 0.0005 mfd. tuning condensers, the two-coil holder, the potentiometer, the 30 ohms and 3 ohms filament resistances, four Clix sockets, and two plugs. The position of these components and the sizes of the necessary holes are given in Fig. 2. Further holes should be drilled for the screws, which are put into the edge of the baseboard, and for the two screws which hold the tops of the fixing brackets.

Next prepare a baseboard 26in. \times 9in. \times $\frac{3}{4}$ in., or use a thinner piece of wood and employ two battens as indicated in Fig. 3. Fix a pair of brass brackets as shown in this illustration, and then prepare and mount in position the valve platform.

This consists of a length of wood 21 $\frac{1}{2}$ in. \times 2in. \times $\frac{1}{2}$ in., and its lower face is mounted 2in. above the surface of the baseboard. The small piece of wood screwed to the top surface of the platform is a stop to prevent the reaction coil striking the coupling condenser, which is connected between the first and second valves.

Fig. 4 gives details of the ebonite terminal strips which should be screwed to the back edge of the baseboard as in Fig. 3.

On the valve platform fix the four valve holders in the positions indicated in Fig. 5.

and also make a pair of ebonite bases with clips to take the two pairs of grid leaks. The valve holder on the right-hand side is the H.F. one, V_1 ; the next is the detector V_2 ; the third, with a pair of grid leaks mounted by it, is the first magnifier V_3 , while the extreme left-hand valve holder is for the last valve, V_4 .

Mounted on the baseboard, by the right-hand end of the valve platform, is the fixed resistor (*R*, Fig. 1), and its 0.3 mfd. shunting condenser, while opposite the small wooden stop is the H.F. choke. This is fixed to a small brass bracket by a screw in a manner obvious to anyone having the component.

Opposite the second valve is an L.F. choke, with a single coil holder (for the grid coil) by its right-hand side, and a 0.125 mfd. coupling condenser on its left

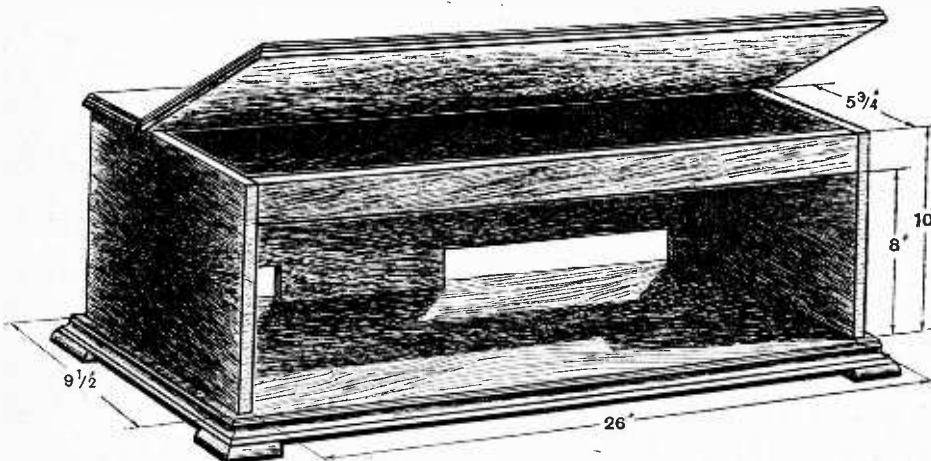

Fig. 6.—Dimensions of a cabinet for the receiver. An important point is the 2in. strip along the upper edge of the front.

of V_4 may be varied by connecting the grid contact to point *c* for full volume, or *d* for a lower volume.

As the grid bias of V_3 is negative 1.5 volts, the largest signal voltage applied to it should be about 1 volt. V_3 magnifies it about eighteen times; therefore the grid bias of V_4 ought to be at least 18 volts. This last valve, V_4 , should be of the low-impedance type described above, being preferably a M.O. I.S5*a*, although a D.E.5*a* will do practically as well. A common filament resistance R_2 of 3 ohms is used for valves V_2 , V_3 , and V_4 , and a 2 mfd. condenser connects +HT₁ to -HT.

Arrangement of the Components.

As will be seen from the illustrations, the components are fixed to a panel and baseboard, and the valve holders

LIST OF COMPONENTS

- | | |
|--|--|
| <p>2 0.0005 mfd. tuning condensers (Igranite).
 1 2 mfd. fixed condenser (T.C.C.).
 2 0.125 mfd. fixed condensers (T.C.C.).
 3 0.3 mfd. fixed condensers (T.C.C.).
 2 0.0005 mfd. fixed condensers (Igranite).
 1 0.0002 mfd. fixed condensers (Igranite).
 1 H.F. choke (Cosmos, Metro Vick Supplies).
 2 L.F. chokes (W. G. Pye).
 4 0.25 megohm grid leaks (Dubilier).
 4 Holders for grid leaks.
 1 Two coil holder (Woodhall).
 1 Single coil holder.</p> | <p>1 1.5 volt grid battery (Burndept).
 1 4.5 volts grid battery.
 2 9 volts grid batteries.
 1 3 ohms filament resistance (Burndept).
 1 Dual (5-30 ohms) filament resistance (Burndept).
 1 Potentiometer, 300 ohms (Igranite).
 1 26 ohms fixed resistor with holder (Burndept).
 4 Antipong valve holders (Bowyer-Lowe).
 11 Terminals, No. 4 B.A.
 4 Clix sockets and two plugs.
 1 Ebonite panel 26in. x 8in. x 5/16in.
 1 Base board, 26in. x 9in. x 3/8in.</p> |
|--|--|

Four Valve-Quality Receiver.—

and next to the platform. On the side nearest the panel is fixed in any convenient manner the 4.5-volt grid bias battery (GB₁) and its shunting condenser of 0.3 mfd. The condenser, which lies in the space between the coupling condenser and the terminal strip, is the plate battery by-pass condenser of 0.3 mfd. On its left is the L.F. choke connected in the plate circuit of V₃, the 0.125 mfd. coupling condenser and the 2 mfd. plate battery by-pass condenser. The battery of two blocks of cells of 9 volts each mounted on the extreme left-hand side is the grid bias for the last valve.

A design for a cabinet to house the set appears in Fig. 6. Notice in particular that the lid opens from the front, and that a two-inch strip runs above the top edge of the panel. The cabinet will give ample room for the coils and valves.

Wiring.

The wiring diagram for this set is printed on a large sheet which has been folded and placed in this copy of the magazine. It will be observed that some wires run below the surface of the valve platform, and they are shown dotted where they pass below. Other wires are marked with lines or crosses; this is done to make it easier to follow out the wiring. No attempt has been made to indicate, for instance, all the grid wires by crosses, and so on.

It will be found that a number of the wires (of No. 16 tinned copper wire) can be put on with the panel removed from the baseboard, and this should be done as far as possible. Lay the wires carefully, bending them to suitable shapes and cutting them to the exact length before soldering. It is a help to tin the points to be soldered first; be sure each joint is a good one.

Testing the Set.

When the set is finished have a final look over it to make sure all the wires are connected and that there is a clear space between them. Then put a 60 milliamperer type of valve in the first holder (V₁), a DE5 in the detector (V₂), a DE5b in V₃, and a DE5a or LS5a in V₄. Valves of this general class should be used, although, of course, there is no great objection to employing a general purpose valve in V₁, except that the fixed resistor R will have to be short circuited, which removes the grid bias from this valve. Connect a 6-volt accumulator, and 45 volts to the first and second valves, and about 130 to the third and fourth. Put a Gambrell B₁

coil in the aerial holder, an A coil in the reaction, and a B coil in the grid coil holder. With a normal aerial and earth it will be found possible to hear several stations on the lower broadcast band on a loud-speaker, which should be connected to the two right-hand terminals on the terminal strip. For Daventry and stations of similar wavelength, put Gambrell coils E₁, A, and E in the aerial, reaction, and grid coil holders respectively.

When receiving the local B.B.C. station and Daventry it will probably be found that the volume is too great. The plug attached to the grid of V₃ should then be put into socket *b*, Fig. 1. If the volume is still too great, and probably it will be, put the plug connected to the grid of V₁ into socket *d*.

It is convenient to set the detector by putting a milliammeter reading, say 0 to 5 milliamperes, in the plate circuit, as at mA₁, Fig. 1. Detune the aerial, and with the potentiometer set to make the grid maximum negative, adjust the value of plate voltage connected to +HT₂ through the milliammeter until the plate current is practically zero. If now a signal is tuned in, it will be found that the milliammeter shows a larger current, and that the current is a maximum when the aerial and grid circuits are in tune with the incoming signal.

To test for distortion, take the milliammeter mA₁ and put it in the plate circuit of V₃ by connecting it between +HT₃ and the battery, and put another meter reading, say, 20mA in the plate circuit of V₁ as at mA₂. Tune in the local station and make adjustments to the plate voltage and grid bias if necessary, until the needle of the milliammeter is practically stationary. V₃ should, of course, be connected to point *b* for strong signals, and it will probably be found that no alteration to the set is needed.

An increase in signal strength with barely perceptible change in the quality can be obtained by using a DE5b valve as the rectifier. If a valve of this type is used, it will be necessary to use a higher plate voltage than when a DE5 is used. The quality will not be quite so good because the impedance of a DE5b is higher than that of a DE5, but, as a matter of fact, the difference can hardly be detected even by listening very carefully.

For a receiver of this sort, of course, a large capacity plate battery should be used. Further, the loud-speaker should be a large one of the best make that can be afforded. The receiver will give a very large volume without noticeable distortion when used with a loud-speaker of good construction, and of a size sufficient for the work it has to do.

THE WIRELESS LIGHTHOUSE

Demonstration of the Revolving Beam System.

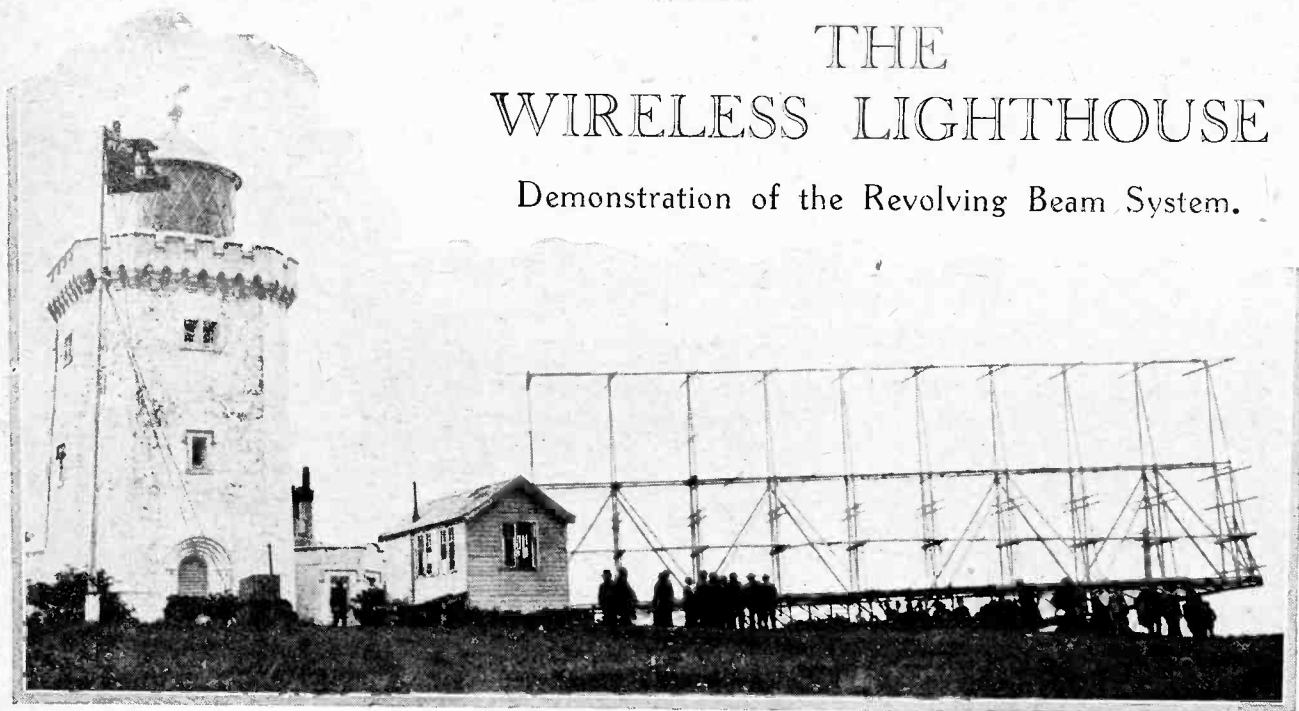

The South Foreland Beam Reflector as it appears to-day. In final form the wooden super-structure will be replaced by steel lattice masts to support the aerial and reflector systems.

THE revolving beam station at South Foreland formed the subject of an official visit by representatives of the Government and certain shipping companies a few days ago. At the invitation of the Marconi Company, the party visited both the South Foreland station and Senatore Marconi's yacht, the *Eletra*, and were able to participate in a demonstration of the revolving beam system during a short cruise extending from South Foreland to Southend. The demonstration was conducted by Mr. C. S. Franklin, and the guests

were entertained personally by Senatore Marconi. As this is the first occasion on which the public has been admitted to view the South Foreland station, it is an opportunity to describe the principle of the system and to give one or two details regarding the method adopted for transmitting the beam signals.

The Beam Principle.

The South Foreland revolving beam consists essentially of a directional transmitter combined with a reflector

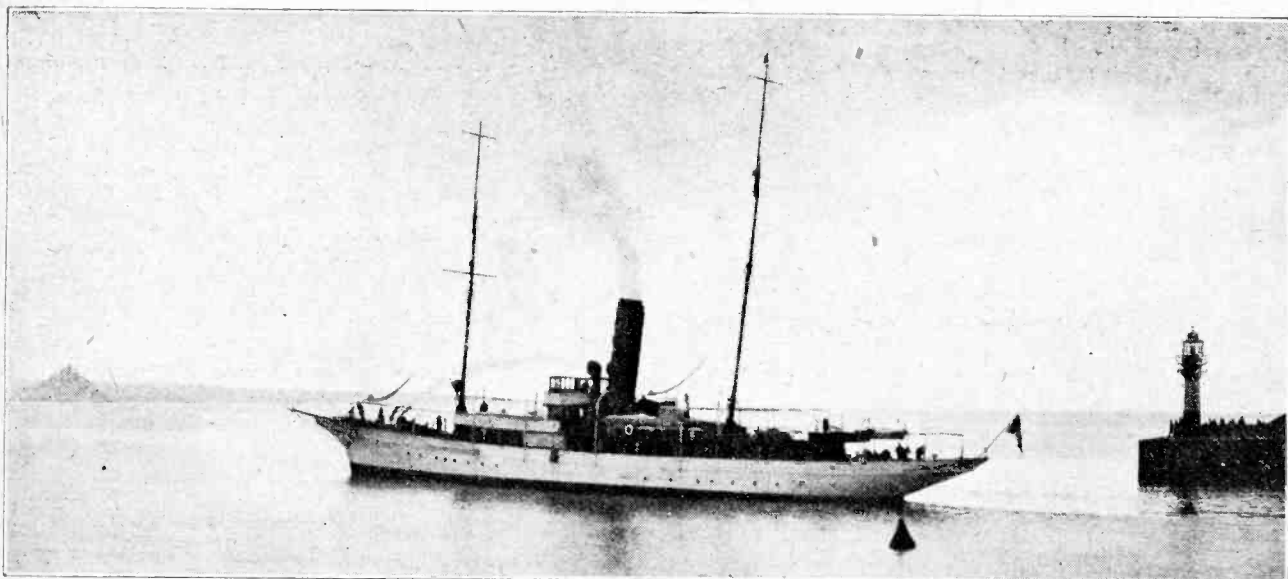

The S.Y. "Eletra," Senatore Marconi's yacht, on which a demonstration was given of the reception of the signals from the South Foreland Wireless lighthouse.

The Wireless Lighthouse.—

which can be rotated and, therefore, transmit in any one direction as required. By arranging a code of signals in such a way that they are transmitted automatically in succession as the radiating or aerial system revolves, it can be so contrived that the same signal is always transmitted whenever the transmission is in any one direction, so that vessels at sea when they receive the distinctive signal know precisely in what direction the beam is being transmitted and can deduce their own position. It is, of course, essential that the transmission of signals should correspond precisely with the changing position of the aerial system as it rotates.

The principle of a rotating directional transmission which sends out distinctive Morse signals as the direction varies has already been made use of, and it is inter-

The reflecting aerials are stated to be spaced a quarter wavelength from the plane of the energised aerials. Very careful attention has to be paid to the precise tuning both of the energised aerials and the reflecting aerials, and provision is made for tuning adjustments by the inclusion of a spiral inductance coil at about the centre of each of the vertical wires.

Transmitting the Signals.

The aerial structure is, of course, arranged so that it rotates continuously at a uniform speed and sends out distinctive signals indicating the direction at which the aerial is pointing at that moment. The transmission of these distinctive signals is arranged automatically by means of plates representing the Morse characters, which are mounted on a large ring carried by the revolving struc-

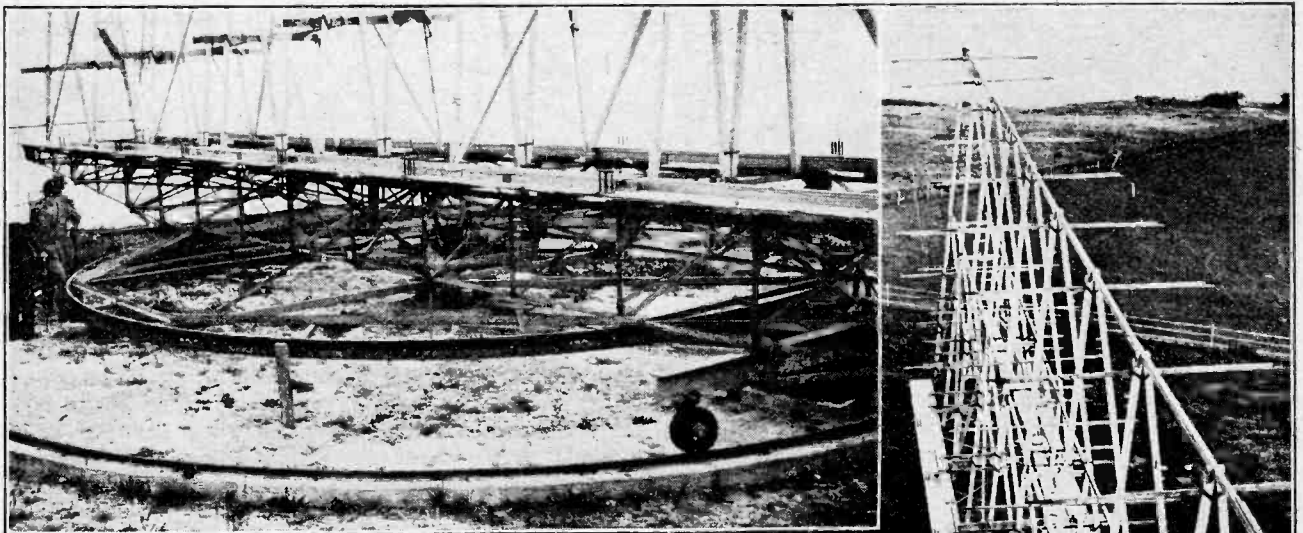

Details of construction of the revolving aerial system. The metal hoop carrying the blocks which automatically operate the transmitter sending Morse characters can be seen below the wooden super-structure.

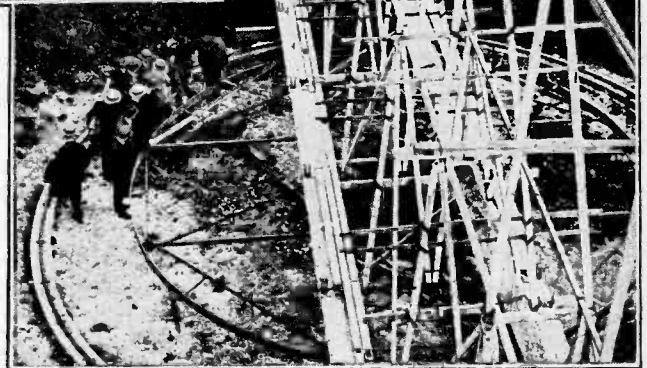

esting to recall that this method was adopted during the war to provide accurate bearings to Zeppelin airships in flight. The application of the idea, however, to the very short wave beam system has important advantages: the wavelength used is stated to be 6.09 metres, and it is claimed that the transmission can be projected in as narrow a beam as 15°, and, due to the reflector principle, in one direction only. The use of such a wavelength ensures that no interference will take place with ships conducting their ordinary traffic, while the narrowing of the beam of radiation should reduce the power necessary to be employed at the transmitter, as well as improve upon the reliability of the bearings taken.

The power supplied to the anode of the valve of the South Foreland transmitter is approximately 280 watts. The leads to the aerial system from the transmitter are carried through insulated wires in an earthed metal conduit. The rotating aerial system comprises a number of energised aerials arranged in a straight line, together with a number of reflecting aerials arranged in a line parallel to that of the energised aerials.

ture. These plates actuate a contact mechanism as the structure revolves and so key the transmitter automatically. The present aerial system is supported on a wooden superstructure, but it is stated that this is experimental, and, in final form, steel towers will be set up at either end of the structure to support the aerial system.

A Wireless Lighthouse.

The system may well be described as a "wireless lighthouse," but it has the advantage that whereas in foggy or stormy weather the illumination of a lighthouse is

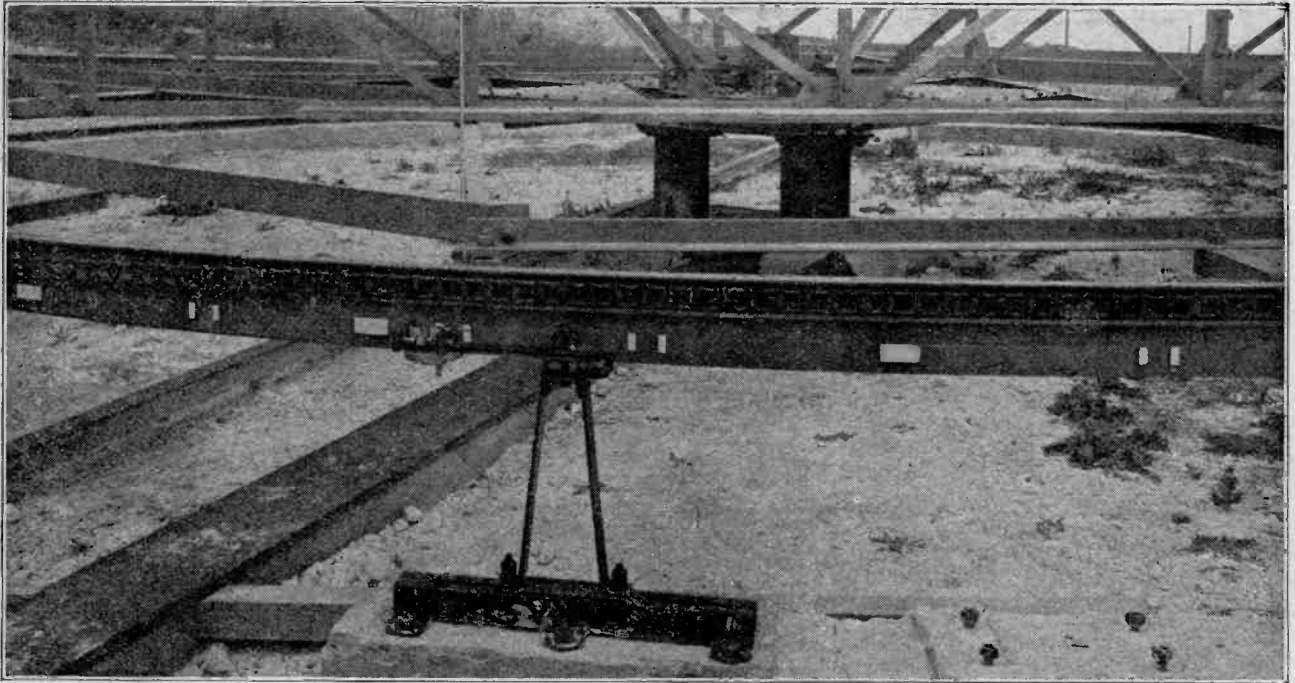

A photograph which shows in detail the method of keying the transmitter automatically by means of blocks mounted on the circular hoop which operate a switch.

often seriously reduced, such weather conditions will not affect the efficiency of the wireless lighthouse. The system can be adopted by small vessels because the receiving apparatus is very simple to handle and can be made extremely compact. In the case of vessels already equipped with wireless, the beam receiver would be an entirely independent unit. It is stated that the range of action of the South Foreland station is approximately the same as that given by a lighthouse under satisfactory weather conditions.

On Senatore Marconi's yacht the *Elettra* reception of beam signals is carried out by means of two receiving aerials mounted one at each end of the bridge. A length of cable connects the aerial system with the receiver, carrying both aerials to the chart room where the receiver is located. A choice of two aerials is given so that for longer ranges the ship itself shall not provide a screen and interfere with reception. It is stated that the South Foreland installation, when under test, has given signals to the *Elettra* up to 100 miles over sea.

Holy Trinity Radio Club.

The opening meeting of the winter session was held on Friday, September 4th.

On Friday, September 11th, an interesting evening was provided by Captain Frost, of the B.B.C., who gave a talk entitled "The General Aspects of Broadcasting."

It is specially hoped to extend the membership of the club during the winter session, and all interested in wireless are cordially welcomed. A warm invitation to attend meetings is extended to members and friends of other societies.

Particulars of membership may be obtained from the hon. secretary, Mr. D. E. Stretton, 15, Thornhill Houses, Barnsbury, London, N.1.

Lewisham and Bellingham Radio Society.

An interesting and useful programme is being prepared for the winter session, which will open at the end of September. The syllabus will contain lectures and demonstrations both for technical and non-technical members.

NEWS FROM THE CLUBS.

Applications for particulars of membership should be addressed to the hon. secretary, Mr. C. E. Tynan, 62, Ringstead Road, Catford, S.E.6.

Bolton and District Radio Society.

A profitable evening was recently spent by members of the society, when Mr. C. H. Bamber, B.Sc., delivered an interesting lecture entitled "Accumulators: Their Care and Charging." The lecturer began by referring to the lack of attention paid to accumulators by many wireless enthusiasts. He then gave some interesting historical details concerning the accumulator, outlining the original crude methods by which electrical energy was stored, proceeding step by step to the more efficient methods of to-day. Among the phases of the subject dealt with were

the design and pasting of plates, heavy and light discharges, strength and purity of the electrolyte, the importance of the first charge, the chemical processes of charge and discharge, and the general care necessary to ensure reasonable length of life for the accumulator. Hon. secretary, J. Grimshaw, 70, Church Road, Smithills, Bolton.

o o o o

Dulwich Radio Club.

The above is the new name of the Dulwich and District Wireless and Experimental Association. The constitution of the club remains the same.

Weekly meetings have been held throughout the summer, and a number of interesting lectures have been delivered. An outstanding lecture was that of Mr. F. C. Smith, who demonstrated an efficient four-valve superheterodyne receiver. Taking into account the small number of valves employed the results obtained were exceptional.

Prospective members should apply for particulars of the club to the Hon. Secretary, Mr. H. J. Camplin, 112, Friern Road, East Dulwich, S.E.22.

the Table-Talker

TRADE MARK

re-designed and improved
—and at a lower price

Never is a Brandes instrument considered free from any further need of investigation. Our constant study of acoustics is continually revealing secrets of the science of sound as applied to radio. In a word, we are always "bullying" the electrical impulse to see if it is possible to improve its transformation to audible sound. A re-designed and improved *Table-Talker* is one result of efforts in this direction. Pleased also, that we can produce such a useful loud-speaker at moderate cost, we are "whipping" up the production to be able to sell it at a reduced price. The *Table-Talker* is, of course, covered by the Brandes guarantee to either return the purchase money or replace the instrument if you happen to be in any way dissatisfied.

Any good dealer stocks Brandes Products.



The horn of the *Table-Talker* has been re-created to aid in the production of clearer and more rounded tones. The new goose-neck design is the result of research in radio acoustics which definitely establishes its value in relation to the diaphragm fitted. One feature remaining unchanged is the patent material used in the construction of horn. It softens and absorbs any suggestion of harshness and avoids metallic resonance. It is now possible to control volume and selectivity with the small lever located at the rear of the base, and to tune in to a finer degree. Elegantly shaped, it still has that tasteful neutral brown finish and felt-padded base. Height 18 ins., bell 10 ins. 30/-

Ask your dealer for the *Table-Talker*.

Brandes

Experts in radio acoustics since 1908

Brandes Limited, 296, Regent St., W.1. Works: Slough, Bucks.

Three other famous Brandes products.

Audio Transformer.



17/6

Ratio 1 to 5. Developed along sound engineering lines to give high amplification of applied voltage with straight line amplification-frequency curve. Well protected mechanically with shielding so that interaction is eliminated. With outside soldering tags, screw terminals and screw mounting base. On comparative test the extra volume and clearness of this transformer are immediately noticeable.

Matched Tone Headphones

TRADE MARK.

Every pair of Brandes 'phones is matched in tone by special apparatus so that the two receivers produce exactly the same sound at the same instant. Comfortable and light in weight with clutch on headband giving perfect adjustment to any head. Included in the leading types of completely equipped receiving sets 20/-



The Brandola.

Special constructional features ensure greatest volume with minimum current input and exceptional clarity over full frequency range. Adjustable semi-goose-neck horn of patent non-resonant material, electroplated fittings and polished walnut plinth, 26" high; 12" bell. 90/-



In answering this advertisement it is desirable to mention "The Wireless World."



Hawk Plug-in Coils

P.P. No. 20289.

Hawk
REG. 1921

THESE COILS are recognised as being one of the most efficient coils on the market. Possessing a negligible amount of resistance and capacity and at the same time being strong, they are capable of being roughly handled without fear of disconnected wires or torn-off plugs and are waterproof.

In the event of your local dealer being out of stock please write to us direct, enclosing his name and address.

Coil	Wave-length using Variable Condenser in Parallel.		Price.
	MAXIMUM.	MINIMUM.	
13	—	—	2/-
25	395	190	2/4
30	435	240	2/4
35	515	350	2/6
40	680	370	2/8
50	835	485	3/-
60	1090	547	3/2
75	1250	600	3/4
100	1820	815	3/10
150	2300	960	4/8
200	3100	1870	5/4
250	3750	2200	5/8
300	4500	2300	6/-
400	4950	2500	6/6

Sole Manufacturers—

THE HAWK COIL CO., LTD.,

St. Mary's Rd., Surbiton,
Surrey. Tel.: 832 Kingston.

Longer Evenings are Coming!

Build the VOKES-McLAUGHLIN one control Super-heterodyne.

Admitted to be the outstanding development in recent Super-heterodyne progress.

The well-known Radio Magazine "Q.S.T." says: "It is certainly a strange sensation to turn one knob and hear station after station come in without any further adjustment."

Full illustrated Constructional Booklet, including two full-size drawings on building this famous set, 2/6 post free. (Booklet free when purchasing Kit of Parts.)

Write or call for list of other high-grade components.

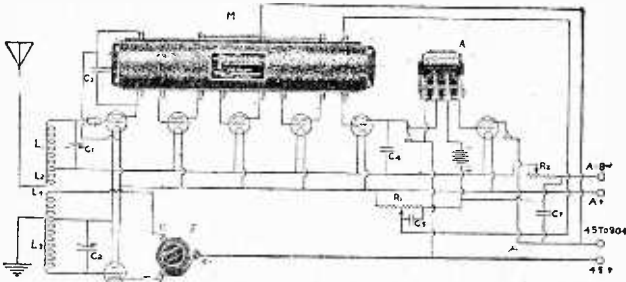

TO GET RESULTS WORTH HAVING YOU MUST INSTALL WADE

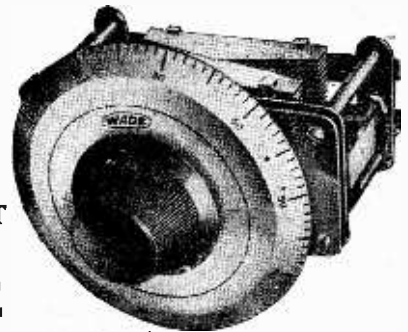

CONDENSERS Pat. Pending.

ELIMINATES BODY CAPACITY.

Special design eliminates body capacity for all time. This is exclusively a Wade development and is destined to change the entire phase of condenser construction.

SIMPLIFIES CLOSE TUNING.

Unique design of plates and their angular operation assures straight line wave length—spreads all stations evenly over the dial. Any station can be quickly located once a given station of known wave length is recorded. Special 360° dial incorporating slow motion spreads the scale and gives more tuning range between stations.

WADE

Square law Condensers, complete with 4 in. Vernier dial for Short Wave 000125 37/6
Tuned Radio Frequency, etc., 00025 49/-
Standard size 0005 22/-

C. G. VOKES & COMPANY (C. G. VOKES, A.M.I.Mech.E.),
38, Conduit Street, Regent Street, London, W. 1

Telephone Gerrard 4693

Telegrams: "Folbert's, Piccy, Ldn."



A Section Devoted to New Ideas and Practical Devices.

SUPPLEMENTARY AERIAL.

WHEN it is desired to enjoy the broadcast programmes in the garden there is no need to disturb the main receiving aerial or the lead-in wire to the house if the following suggestion is adopted.

Instead of using cord or stranded steel wire for the aerial halyard, substitute some form of insulated elec-

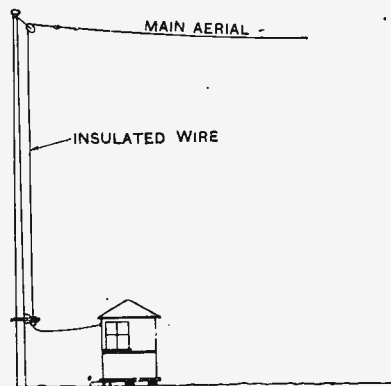

Halyard as supplementary aerial for outdoor use.

trical cable such as "Electron" wire. The halyard may then be used as a subsidiary aerial, a lead-in being taken to the set which may be installed, say, in an adjacent summer house. The aerial formed in this way is by no means perfect, but it is quite good enough for the reception of the local station, and allows the experimenter to continue his work with the main aerial while other members of the household enjoy the programmes with an auxiliary set.—J. G.

o o o o

FLASH LAMP BATTERY CONNECTIONS.

An excellent method of connecting flash lamp batteries together to form a H.T. battery is to use the backs of disused single-edged safety razor blades. The steel blade is removed from the back with a pair of pliers.

The brass connecting strips on the flash lamp batteries are cut down to a length of about 1/4 in., and the batteries are placed side by side with positive and negative contacts in juxtaposition. Adjacent contacts are then connected together in pairs, using the razor blade backs as clips.

—I. H. Q.

o o o o

VALVE SOCKETS FROM TUMBLER SWITCHES.

The threaded sleeve shown in the diagram will be recognised as the terminal in an ordinary tumbler switch into which the connections are inserted. These make excellent valve sockets, and are generally to be found in sufficient quantity in the local electrician's scrap box. Most types are fitted with a threaded collar which serves to hold the socket in

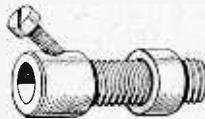

Tumbler switch terminal, suitable for use as valve socket.

position in the panel, while the set screw ensures a perfect electrical contact with the valve pins, and would prevent the valve falling out, say, in a portable set if it should be inverted by accident.—H. E. T.

Valves for Readers.

For every practical idea submitted by a Reader and accepted for publication in this section the Editor will forward by post a receiving valve of British make.

AERIAL CIRCUIT CONNECTIONS.

The diagram shows a useful method of connecting two variable condensers with capacities of 0.0003 and 0.0005 mfd. respectively to tune the aerial circuit of a receiver. The condensers are connected in series between three sockets, 1, 2, and 3. One end of the aerial coil L is connected to the socket 2 and the other end to the earth terminal. Plugs A and E are connected to the aerial and earth terminals by short lengths of flexible wire. With A in 1 and E in 3 the 0.0005 mfd. condenser is

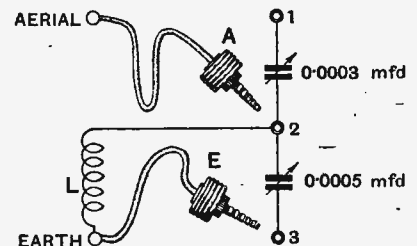

Plug and socket switching giving four alternative methods of connecting the aerial tuning condensers.

in parallel with the tuning coil, and the smaller condenser is in series with the aerial. The 0.0003 mfd. condenser may be connected in parallel, and the larger condenser in series by plugging A into 3 and E into 1. If desired, a series condenser may be dispensed with altogether by connecting A permanently into socket 2 and E alternatively into 1 or 3, when the 0.0003 mfd. or 0.0005 mfd. condenser respectively will be connected in parallel with the coil L.—I. A. G.

o o o o

COUPLING INDICATOR.

The coil holder illustrated in the diagram is mounted on the baseboard of a receiver behind the main panel. The motion of the moving coil plug is governed by a worm wheel, which engages with a toothed segment fixed to the moving coil pivot. The worm

wheel is mounted on a spindle passing through a bushed hole in the front panel and provided with an adjusting knob. Obviously, many revolutions of the worm wheel are necessary to move the reaction coil through 90° , and the coupling cannot be indicated by a pointer or dial fixed to the rotating knob. Some means of indicating the coupling is essential, however, since the coils are out of sight inside the set.

A neat and effective way of obtaining this indication is shown in the diagram. An eccentric cam E is mounted on the moving coil pivot between the toothed segment and the side of the coil holder, and is arranged to control the movement of a pivoted arm P. The opposite end of the arm acts as a pointer and moves up and down with the movement of the coil in a slot S in the

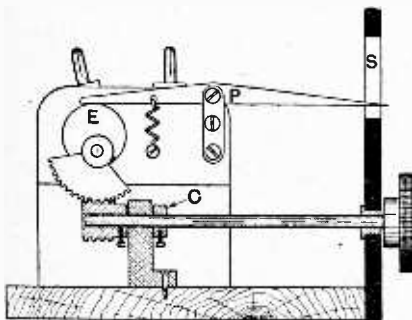

Geared coil holder with coupling indicator.

front panel. On one side of the slot a scale of degrees is permanently marked, while on the other side a xylonite strip may be used to make pencil notes of the setting of the pointer for individual stations.—R. E.

o o o o

COIL HOLDER CONNECTIONS.

Having experienced breakage troubles with flexible leads to the moving coil in a two-coil holder, the writer has adopted with great success the flexible strip connections shown in the sketch.

The spring strips are attached between brass pillars screwed into the ebonite end plates of the coil holder and stiff wire arms clamped under the set screws in the moving coil holder. The pillars may consist of No. 4 B.A. cheese-head screws, secured with a lock nut, and the leads to the set may be soldered into the slot in the head of the screw. No. 16 S.W.G.

A 24

tinned copper wire may be used for the arms, which must be so shaped that they allow the reaction coil to be tightly coupled without fouling the end-plates of the coil holder.

The flexible strips should be cut preferably from thin phosphor-bronze sheet, but copper or brass foil may be

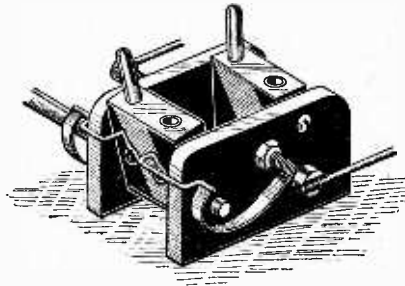

Improved moving coil connections.

substituted if the former material cannot readily be obtained. The success of the device will depend largely upon the skill with which the strips are soldered to the supports. Too much heat may soften the material near the join and cause a weak spot which will soon break. It is essential to tin the parts before finally soldering together, and sufficient solder should be employed to fill all corners and give a nice rounded joint. If desired, the strips may be cut slightly wider at the ends to give additional strength where it is most required.

When properly carried out, this method will be found to be a great improvement, as it is not subject to the noises usually associated with spring washers and other frictional contacts, and is mechanically sounder than flexible wire connections.—S. R. M.

o o o o

USE FOR DAMAGED VALVES.

It frequently happens that the filament of a valve sags and touches the grid before the life of the filament has been completely exhausted. It is then useless, of course, as a three-electrode valve for amplification and grid rectification, but it can be quite successfully employed as a two-electrode valve rectifier. The filament current is now supplied through the grid and one of the filament legs.

A variable resistance and an ammeter are placed in series with the filament, and the current adjusted to the value specified by the makers for the particular make of valve. If a

voltmeter is available, the voltage across the remaining part of the filament may be read off for future reference, or, alternatively, the setting of the variable filament resistance may be noted in order that there may be no danger of exceeding the normal filament current.

The writer has used a 0.06 type valve in which the filament is fused to the grid for some time as a rectifier in a reflex circuit. The increase in stability has been much appreciated, and several stations have been logged which were not heard when a crystal rectifier was employed.—J. B.

o o o o

VARIOMETER SWITCHING.

Many systems have been devised for obtaining the maximum tuning range from a variometer. Most of them involve the use of series and parallel fixed condensers, and all make use of the expedient of connecting the windings alternatively in

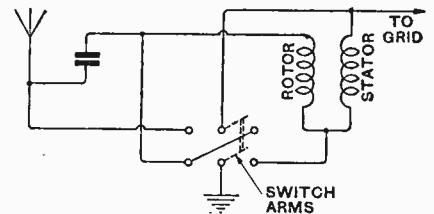

Simplified variometer switching for the lower P.F.C. and Daventry wavelengths.

series or in parallel. Complicated switches with two or three positions and as many as five sets of contacts are often used to cover the complete wavelength range from 200 to 2,000 metres.

Now the average broadcast listener is not much concerned with wavelengths between 500 metres and the Daventry wavelength of 1,600 metres, and in consequence a considerable reduction in the number of contacts and amount of wiring may be effected. Only a two-pole change-over switch is necessary, and the circuit is given in the diagram.

With the switch to the right, the windings are connected in parallel with the fixed condenser in series, giving, with suitable turns in the two coils, the lower B.B.C. wavelengths. With the switch to the left, the windings are in series and the condenser in parallel, giving, with the same number of turns, a wavelength range which includes the 1,600-metre wave —R. G. A.

16

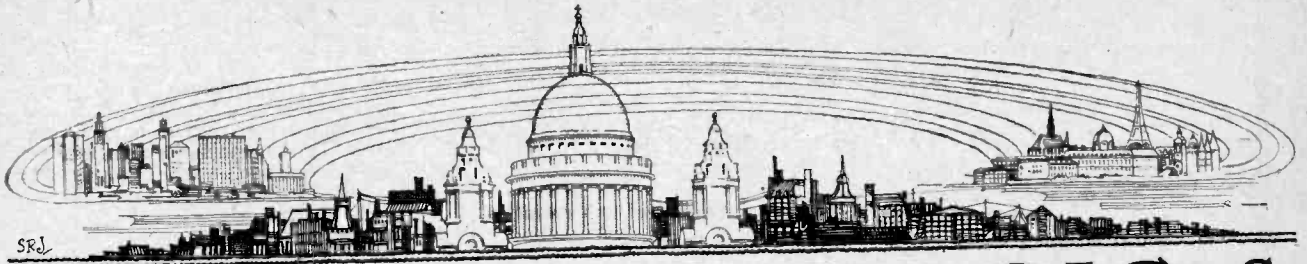

CURRENT TOPICS

Events of the Week in Brief Review.

MARCONI'S FIRST RECEIVER.

Visitors to the Wireless Exhibition at the Albert Hall should not fail to see Marconi's first wireless receiver, which is being shown in the main hall.

○○○○

FILLING THE GAPS.

During intervals in the programme of the Berlin broadcasting station the letter B is transmitted in Morse every three seconds.

○○○○

BERNE MUNICIPALITY SUPPORTS BROADCASTING.

The Municipal Council of Berne, Switzerland, has contributed a sum of 20,000 francs towards the establishment of a local broadcasting station.

○○○○

LICENCES ON THE INSTALMENT PLAN.

Large as the 10s. broadcast licence fee may appear to certain listeners in this country, it pales into insignificance beside the £2 5s. required from South African listeners, who, incidentally, have the choice of only three programmes, viz., those of Capetown, Durban and Johannesburg. The authorities have found it necessary to arrange a system of "easy payments."

○○○○

WIRELESS RELIEVES DOCK CONGESTION.

Broadcasting is stated to be solving the question of harbour congestion at New York. A telephony transmitter is employed by the New York Central Railroad to direct the movements of craft in the docks, and instructions have been given to more than 100 harbour boats simultaneously.

○○○○

THOUGHT AND ART IN RADIO.

The last month has seen the formation in Paris of the "Cercle Interallié," a national association which will strive to educate public taste in thought and art through the medium of broadcasting.

Outlining the programme of the new association, M. Elie-Berthet, general secretary, states that use will be made of existing stations, and possibly of new ones, to disseminate programmes having an inspirational and educational appeal. The Committee of the Association includes many prominent artists, scientists and men of letters.

BROADCASTING FOR AUSTRALIAN COUNTRYSIDE.

The Queensland Government, having opened the State-owned broadcasting station 4QC, is now considering a scheme for extending the broadcasting service by installing low-power stations in each of the main country towns. Such a step, it is believed, will go far towards inducing the population to settle further inland in districts which are at present almost entirely cut off from the outside world.

○○○○

SIGNALS FROM RIFF LEADER?

Listening on a wavelength between 35 and 40 metres on the night of Sunday, September 6th, Mr. W. S. Williams, of Rock Ferry, Cheshire, was surprised to pick up the following:—

CQ V ABDEL KRIM.

The call was repeated several times. Our correspondent cautiously asks whether this can be a case of "leg-pulling" or whether the call was genuine. Other readers may be able to corroborate his experience.

DR. LEE DE FOREST ON EUROPEAN WIRELESS.

Dr. Lee de Forest, the famous wireless engineer, who has just returned to America after a tour in Europe, has described in an interview his impressions of European broadcasting.

"The interest is greater in England," said Dr. de Forest, "probably due to the fact that there the programmes are more diversified than in the rest of the European countries. France, of all nations, pays the least attention to its programmes. For that reason French listeners build receivers capable of hearing the English stations, where better balanced programmes are offered."

On the subject of valves Dr. de Forest stated that in the English market he personally noticed 87 different types, all of very high quality. Their variety especially interested him, and the fact that some manufacturers place from 18 to 20 different styles on the market prompted the famous inventor to remark that "the result is one that would puzzle!"

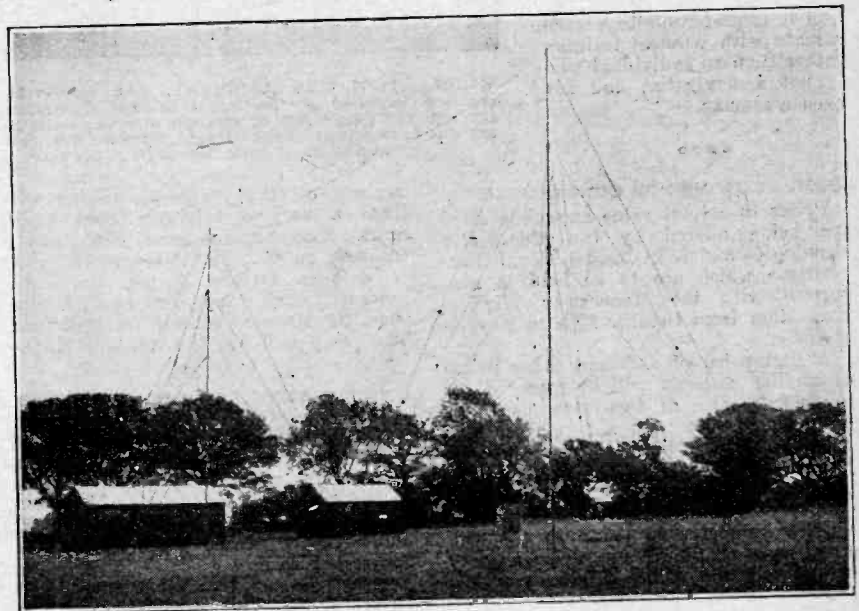

THE SUPER RECEIVING STATION. A new photograph of the B.B.C. receiving station at Hayes, which will be used for relaying foreign programmes, tracking down interference, and experiments with new apparatus. "Laker" tubular steel masts have been erected.

RECEPTION TESTS ON FRENCH BROADCASTING.

Observations on the comparative strength of French broadcasting stations as heard on the South Coast of England have recently been carried out by a representative of our contemporary, *La T.S.F. Moderne*.

The experiments, which were made with a single-valve set, showed that Radio Paris can be heard perfectly at night but very poorly during daylight. Radio Toulouse and Radio Agen both gave good results, while other stations heard, shown in the order of strength, were Paris P.T.T., Petit Parisien and Radio Lyons.

○○○○

SOUTH AMERICAN WIRELESS CHAIN.

A scheme to form a wireless chain to link up Lima, Buenos Aires, Bogotá, Rio de Janeiro, and the United States is stated to be under consideration by the Peruvian authorities. A proposed 25-year concession to the Marconi Company is now being discussed by Congress. An expenditure of £500,000 would be involved.

○○○○

WIRELESS OPERATOR OR WIRELESS MATE?

The advisability of training ships' mates in the operation of the wireless installation on board ship was the subject of an interesting discussion at the seventh congress of northern captains, held recently at Copenhagen.

It was unanimously agreed that when circumstances demanded an extra man on board to attend to the installation it is preferable to engage a mate with wireless training rather than an individual who is not a navigator, and not even a seaman.

○○○○

COMPETITIONS FOR CONSTRUCTORS.

Prizes to a total value exceeding £150 are being offered by the *Manchester Evening Chronicle* in Constructional Competitions which are to be held in connection with the Manchester Wireless Exhibition from October 27th to November 7th.

A first prize of £25 and other prizes of smaller amounts will be awarded for the construction of two-valve amplifiers designed for use with a crystal or one-valve receiver. The amplifiers will be judged on the volume and purity of reproduction, ease of manipulation and quality of workmanship.

Other competitions relate to the construction of single-valve receivers, novelty crystal sets and school children's crystal sets.

A form of application containing full particulars may be obtained from the Radio Editor, *Manchester Evening Chronicle*, Withy Grove, Manchester.

B 2

CABINET WIRELESS.

The New South Wales Cabinet is considering a scheme whereby Parliamentary debates will be transmitted by wireless to Ministers' rooms to save them the trouble of attendance in the House while transacting ministerial duties.

The scheme seems ingenious but likely to impose severe demands on the ministerial powers of concentration.

○○○○

NEWS BULLETINS FROM CENTRAL AUSTRALIA.

A possibility exists for British amateurs to pick up 20-metre transmissions from the arid wastes of Central Australia, provided that the plans of the Australian Inland Mission materialise. Under the auspices of the Mission, a party has set out to tour the central

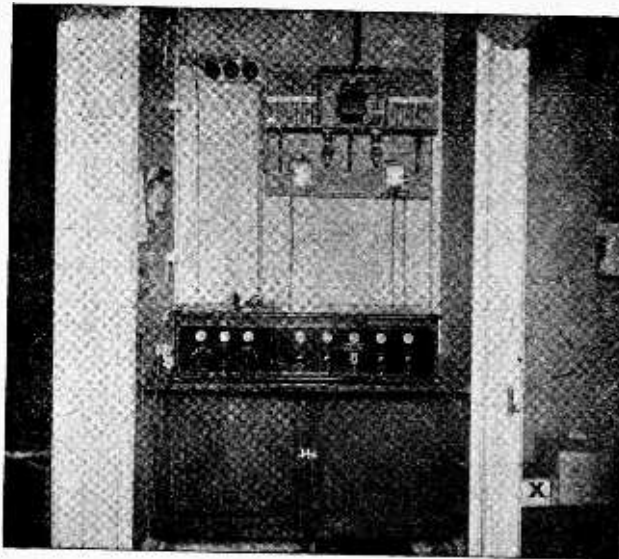

WIRELESS IN THE HOSPITAL. An eight-valve broadcast receiver installed at the Royal London Ophthalmic Hospital, through the generosity of readers of "The Daily News." The set was constructed by the Oxford Wireless Telephone Co., Ltd., and is fitted with Ostram (G.E.C.) valves.

regions of the continent, taking with them a very complete wireless equipment. Arrangements have been made to transmit on 600, 250, 80, and 70 metres at definite periods during the entire journey. Each Sunday, at noon, Eastern time, the 20-metre set will transmit news. The party will use the call sign 8AC.

○○○○

NEW PATENT LAWS IN IRISH FREE STATE.

Valuable interests will be involved in the changes arising from the new Patents Laws which will shortly come into force in the Irish Free State. On the passing of the new Act all British patents will automatically cease to function in Saorstát Éireann.

British patents, however, granted before December 6th, 1921, will be continued upon the Irish Register if a copy of the patent is lodged in Ireland and renewal fees are paid as in England.

British patents applied for after Decem-

ber 6th, 1921 and before the passing of the Act will be granted, subject to a search in the Irish Register.

Should an application for a patent be made without reference to any earlier British patents, then it must be accompanied by the report of a registered patent agent based upon a search for novelty in the British records.

Should any of our readers desire fuller information on this subject, Messrs. Rayner and Co., patent agents, of 5, Chancery Lane, London, W.C., will be glad to supply it free of charge.

○○○○

AMERICA'S AMATEUR SIGNAL CORPS.

The extent to which the American amateur is recognised and encouraged by the authorities is shown by the news of plans to establish a corps of civilian radio operators to assist the U.S. Army Signal Corps. The American Radio Relay League is being asked to represent the transmitting amateurs of the country in organising the scheme.

The primary aim is to create a network of army-amateur radio stations throughout the country. When enrolled amateurs will be asked to act as communicating stations for battalions, regiments, brigades, divisions and corps area headquarters. A strong defence unit of civilian stations will thus be built up for valuable work when the land lines are out of action, either through storm, civil commotion, or actual warfare.

○○○○

A COMPONENTS SERVICE.

Enquiries are constantly being received from readers of *The Wireless World* who wish to be recommended to wireless firms who will undertake to construct for them components or detailed parts of constructional sets described which are not already on the market. We should be pleased to hear from any manufacturers who are willing to undertake to make up such components, in order that we may supply their names to our enquirers.

○○○○

COSMOS CRYSTAL RECEIVER.

In connection with the review of this receiver, which appeared on page 265 of the issue of August 26th, we would point out that the components tapped alternatively across one-third, two-thirds, or the whole of the tuning coil are the detector and telephones, and not the condenser, as previously stated.

○○○○

BOOK RECEIVED.

"Loud-speaker Crystal Sets."—A Practical Handbook, edited by Bernard E. Jones. 138 pages. 140 illustrations. (London: Cassell and Company, Ltd. Price 2s. 6d. net.)

AROUND the STANDS at the WIRELESS EXHIBITION



Classified Review of the
Apparatus Exhibited at
the Royal Albert Hall.

IN declaring the Exhibition open, Lord Wolmer, Assistant Postmaster General, drew attention to the lead being taken by British radio manufacturers in the development of the industry. The superiority of British apparatus, he said, was now established, whilst the British broadcasting organisation was probably an example to the world. He referred especially to the elimination of politics in the programmes and contrasted broadcasting in this respect with the newspaper and cinema.

The dimensions of the industry can be judged by the fact that in Great Britain alone the probable number of listeners is approximately ten millions and the value the service is rendering to the public is almost inestimable.

* * * *



Mr. W. W. Burnham took the chair at the luncheon held by the trade association. On his right is Senatore G. Marconi, G.C.V.O., and on his left Captain Ian Fraser, M.P.

Crystal Receiving Sets.—The simplicity of the crystal receiver leaves little scope for the construction of instruments of new design, and among the sets to be seen mention can only be made of a few minor refinements. For instance, in the new crystal set of Metro-Vick Supplies, Ltd., provision is made for connecting the crystal across only a portion of the total number of turns of wire employed in the tuning circuit, and thus the extent of damping produced by the crystal and telephones can be controlled. This receiver is condenser tuned, as are many of the other higher-class crystal receiving sets. The variometer method of tuning so universally adopted in the past has been almost abandoned. The Polar crystal set is a compact instrument, condenser tuned, and a suitable inductance value is obtained by means of a plug-in coil. The detector is of entirely new design, having a

sensitive adjustment without the use of micrometer movements. The majority of sets adopt the plug-in coil method of tuning, so as to simplify changing over from the 300-400-metre band to the 1,600 metres of Daventry.

The crystal detector is no longer employed in place of a valve in valve receiving sets to effect an economy in filament current, and in multi-valve receivers, as well as in detector sets with note magnifiers, valve detection is adopted. Tuning coils especially constructed for high efficiency are not made use of, probably on account of their bulk, and the very doubtful improvement which might result. Testing buzzers which were fitted in the past, are no longer to be

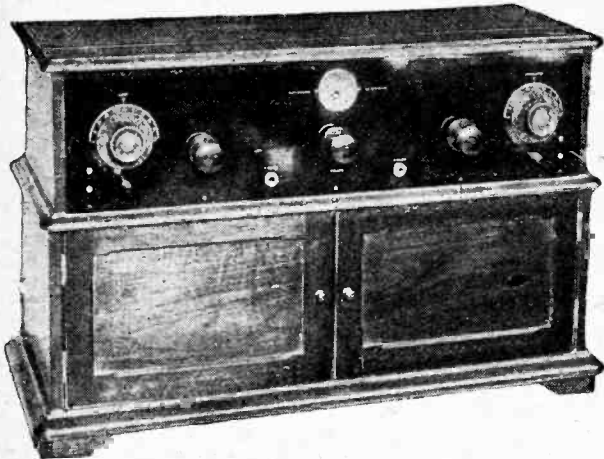

The Bowyer-Lowe superheterodyne receiver is a compact set and provision is made in the cabinet-work for housing the batteries so that it is an entirely self-contained outfit, the only external connections being those to the frame aerial.

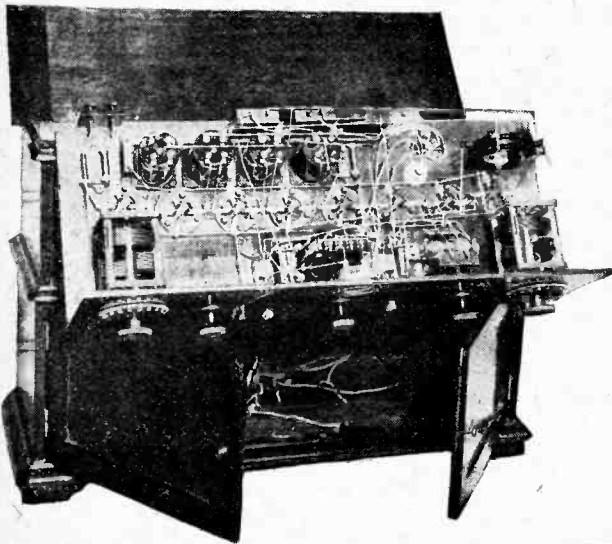

Layout of the components on the baseboard of the Bowyer-Lowe superheterodyne receiver. The tuning condensers are divided into sections to balance the plates.

found on crystal sets, experience probably having shown that it is easier and more reliable to adjust the detector on the incoming signals.

Among the several crystals to be seen on the stands might be mentioned "Permanite," which was placed on the market by Messrs. A. W. Gamage, Ltd., several years ago; the new crystal of the Radio Communication Co., Ltd., "Neutron" Synthetic Crystal, "Sylverex," consisting of carefully selected specimens of natural galena, and "Kathoxyd," which is entirely new, and consists of a small brass cup and a metal plate covered with a chemical compound.

Valve Receiving Sets.—Reference has been made in detail in the previous issue to the many models exhibited, and an inspection of the new apparatus calls for little comment. Many of the sets have been completely redesigned since last year, both as regards tuning range, general layout, and cabinet work.

At least five superheterodyne receivers are being shown, all of which now appear on the market for the first time. The circuit arrangements used and the form of construction adopted in the various instruments differ widely. The Gecophone superheterodyne receiver makes use of eight valves and employs three intermediate high-frequency amplifiers and two optional low-frequency stages. Tuning over a waveband of 175 to 3,000 metres is accomplished by means of interchangeable plug-in units. The intermediate high-frequency amplifying equipment is totally enclosed in a metal case beneath the valve holders and high-frequency iron core transformers are employed, in conjunction with high amplification Osram valves of the DE5B type, operating on a wavelength of 4,000 metres. The frame aerial is carried on a bracket attached to the end of the cabinet, and a polished mahogany case is provided for the batteries. Another interesting superheterodyne set is to be seen at the stand of Messrs. Burndep Wireless, Ltd. It makes use of seven valves and comprises two intermediate high-frequency amplifiers, two optional low-frequency amplifiers, separate oscillator valve, and the two detectors. A feature of this set is that no grid batteries are employed, the necessary potentials either being obtained by resistances

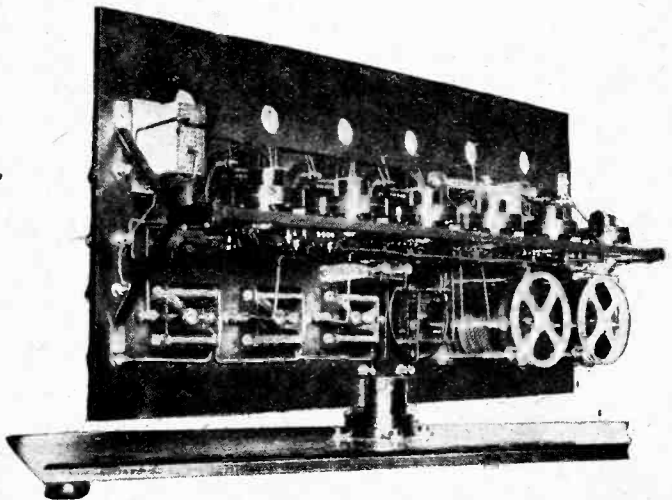

A carefully considered layout is adopted in the R.I. superheterodyne so that the wiring is effected with short leads. Any of the components can be procured separately for the home construction of a superheterodyne receiver.

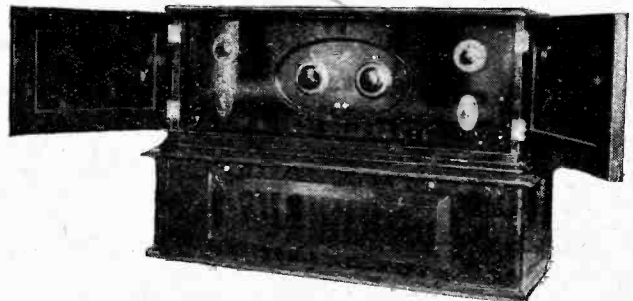

The new Burndep superheterodyne embodies many novel features. The front panel is of polished mahogany and the arrangement of the tuning controls renders manipulation simple, removing the appearance of an involved scientific instrument so often possessed by wireless receiving sets.

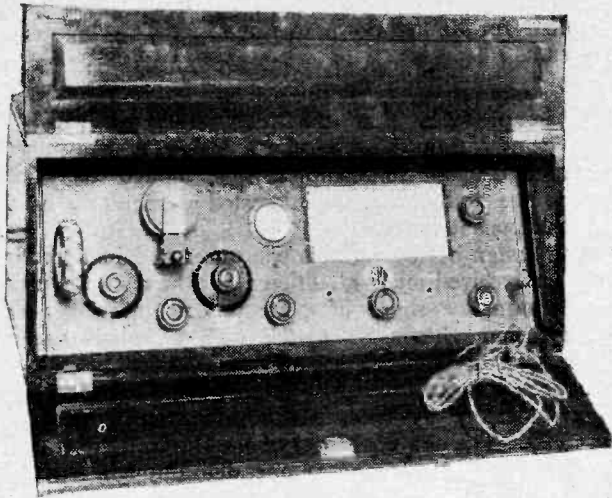

Four-valve cabinet receiver shown by Gent & Co., Ltd. The aerial circuit is tuned by means of a plug-in Tangent coil and the intervalve high frequency transformer is fitted with adjustable reaction. A chart on the face of the panel shows the adjustment of coils and dials for tuning to given stations.

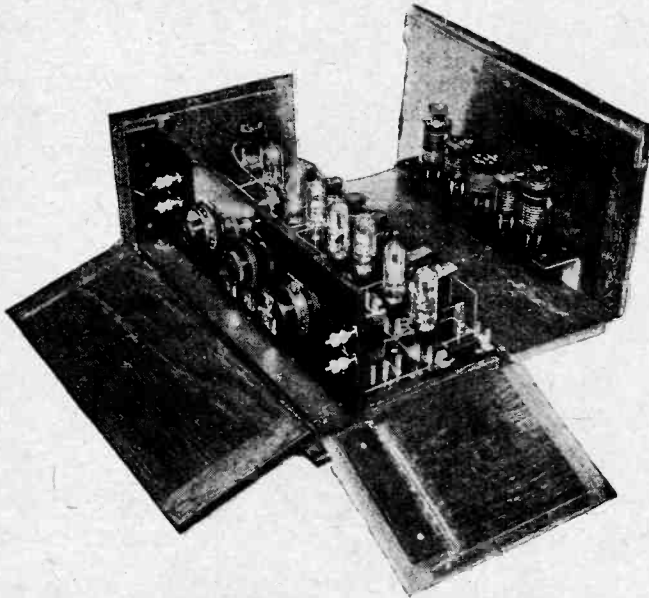

The superheterodyne receiver made by Messrs. L. McMichael, Ltd., is compact yet easily accessible. It is the only superheterodyne receiver exhibited in which a single valve serves as first detector and local oscillator.

connected in the filament leads, or, as in the case of the low-frequency amplifiers, by picking up potentials developed across resistances connected in the plate circuits. The grid potential of the first detector is adjusted so as to provide anode rectification. A wavelength of 6,000 metres is adopted in the intermediate amplifier and the transformers are fitted with cores of steel stampings, the primary spool being assembled between the two halves of the secondary. Reaction is introduced by means of a tapping on the frame aerial, and an interesting feature is the provision of separate frame aerials for reception on the waveband 250 to 550 metres and 1,000 to 2,000 metres. The frame aerials are entirely constructed of ebonite to avoid the use of metal parts in the

field of the coils. As can be seen from an accompanying illustration, a unique layout has been adopted for the manipulating controls on the front of the instrument, which is of polished mahogany, and the dial positions are chosen, not only to produce symmetry, but to facilitate the making of the tuning adjustments. The condenser dials operate through reduction gear of $7\frac{1}{2}$ to 1. Burndept type valves are fitted, and when the set is in operation with all valves in use, the filament current is less than 1 ampere. No wiring is visible when lifting the lid for inserting the valves. Messrs. L. McMichael, Ltd., have introduced a very compact superheterodyne operating on the "Autodyne" principle, in which the first valve functions as both detector and oscillator. It is fitted with three intermediate high-frequency amplifying stages and two optional low-frequency amplifiers. For a superheterodyne receiver it occupies very little space, and the panels of the containing cabinet are hinged together so as to completely expose the set and its wiring, the latter being excellently carried out. McMichael components are employed throughout, which provide an extensive tuning range by interchanging various inductance units. Making use of their standard superheterodyne components, Messrs. Radio Instruments, Ltd., also exhibit an attractive superheterodyne receiver. A portable six-valve superheterodyne, built according to standard practice and fitted with an enclosed type loud-speaker, is now included in the range of the receiving sets of the British Thomson-Houston Co., Ltd., while among the cabinet type models should be included the superheterodyne receiver of Messrs. Beard and Fitch referred to in the previous issue.

Very few examples are to be found of valve receiving sets in which reflex circuits are employed. Single-valve receivers also are very little in evidence, while two-valve models consisting of detector and note magnifier are gaining in popularity and are intended for loud-speaker operation from local stations. Sets are also available for long-

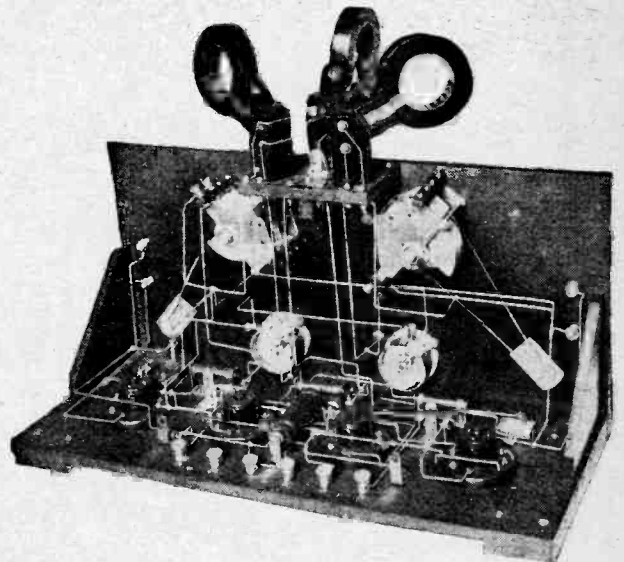

An amateur constructed receiver built entirely with components manufactured by Metro-Vick Supplies, Ltd. The remote condenser adjustment by means of a cord and pulleys serves the double purpose of providing critical control and eliminating hand-capacity effects.

are fitted with plug-in tuning inductances, and coils are supplied for tuning down to wavelengths as low as 40 metres.

Components.

It is probable that the high standard which is now being attained in receiver design is causing an increased demand for complete sets, though many visitors to the Exhibition are interested particularly in the new component parts.

The design of the variable condenser and its operating dial has received much attention from the manufacturers. The square law shape of plate is now invariably employed, and aluminium plates with nickelled spacing washers, at one time almost universally adopted and still to be seen in many excellent condensers, are being replaced to some extent by brass plates and other methods of assembly. The new condenser of the General Electric Co. employs brass plates and is operated through reduction gearing, not of the usual toothed pinion wheel type, but is fitted with spring metal discs making good friction contact with small bevelled wheels. A positive drive is thus obtained without backlash, the operating knob and dial being, of course, separate, though concentrically assembled. Metro Vicks Supplies, Ltd., have fitted a simple method of critical control consisting of an additional knob carrying a small pulley wheel, which is coupled up behind the instrument panel with a larger pulley on the condenser shaft. This auxiliary fine tuning adjustment may be fitted on the instrument panel at some distance from the condenser which it controls, thus avoiding hand capacity effects. An auxiliary spindle is also made use of by Radio Instruments, Ltd., for providing critical adjustment, operating on a large grooved wheel. The condenser is a particularly robust job, and a very substantial brass end mounting plate is fitted to entirely



An attractive four-valve receiver with cabinet enclosed loud speaker to be seen at the stand of F. E. Wootten, Ltd. The ebonite panel is given a rippled finish so that it will retain a clean appearance.

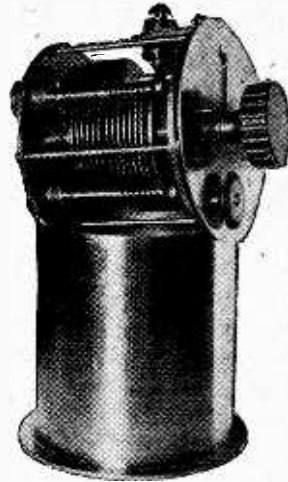

The standard condenser of the Dubilier Condenser Co., fitted with balanced plates and substantial insulating bushes of clear mica. The auxiliary knob is for fine adjustment and the pointer is fitted with a vernier scale.

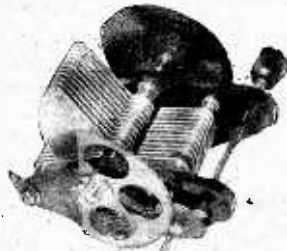

Geared condenser with a 60 to 1 reduction ratio of F. E. Wootten, Ltd.

range reception on head telephones in which the two valves are connected as high-frequency amplifier and detector. The tuned anode circuit for high-frequency amplification is more generally employed than the transformer method, though in a few instances H.F. transformers are to be seen fitted with reaction coupling. The experimenter will doubtless be disappointed if he expects to see anything new in the stabilising of high-frequency amplifiers, and in no instance is a circuit employed in which self-oscillation is controlled by an inductance and condenser for producing a reversed potential to counteract the grid plate coupling inherent in the valve.

There are many specimens of the four-valve set consisting of high-frequency amplifier with detector valve and two low-frequency stages, mostly fitted into attractive cabinets, and in some instances having a totally enclosed loud-speaker. An original feature has been introduced into the "Polar Four" of the Radio Communication Co., Ltd., for it is fitted with duplicated tuning equipment. By this means the set can be separately tuned to two transmissions, usually the local station and Daventry, and by means of a relay with remote control either of the tuners may be brought into use.

In the various sets for broadcast reception the tuning range invariably includes both the 250 to 450 metre band, as well as 1,600 metres. Several of the models manufactured by the Sterling Telephone and Electric Co., Ltd.,

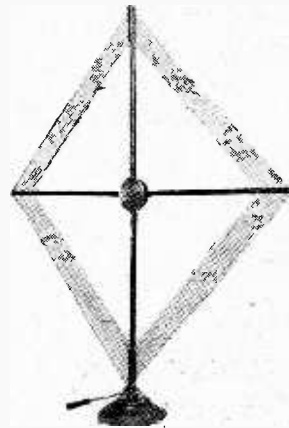

Collapsible frame aerial fitted with ebonite supports and calibrated dial at the base on the stand of F. E. Wootten, Ltd.

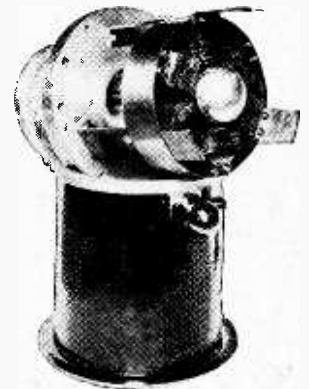

High tension Dubilier condenser for use in high-powered transmitting equipments.

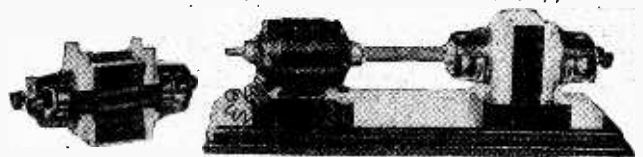

M.L. generators are now available for producing both high and low tension supply from electric lighting mains.

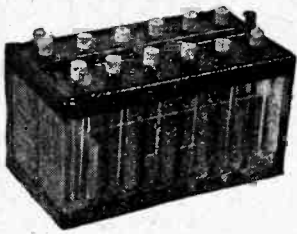

The new Exide high tension battery.

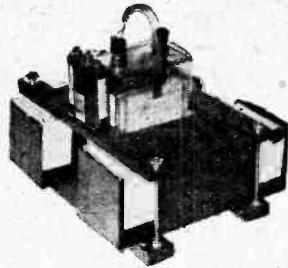

Cosmos battery unit consisting of a carrier for grid cells as well as high and low tension batteries.

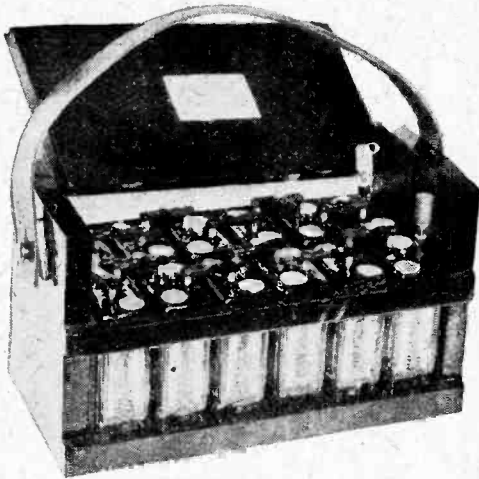

Ediswan portable secondary battery for high tension supply.

eliminate any risk of this component becoming distorted when clamped up to the panel by means of the nut and bush of its one hole fixing. The condenser of Messrs. F. E. Wooten, Ltd., operates through a toothed segment, giving a reduction gear of 60 to 1, is fitted with "pig-tail" connector to ensure good contact with the moving plates, and it is attached to the panel by one hole fixing. The Polar variable condenser has a cam vernier action, so that for a small movement of the knob the moving plates are operated through the equivalent of reduction gear, whilst, if given a larger movement, plates and operating knob will move together. Within ordinary practical limits, this Polar condenser is a true square law instrument, dial reading and wavelength being

exactly proportional, a property which is achieved by ignoring the zero end of the scale where the self-capacity of the tuning coil is appreciable compared with the rest of the condenser, and making the first calibration mark on the dial near the position of 30°. The Burndy "Supervernier" dial gives a reduction of about 7½ to 1, and operates through an epicyclic gear concealed beneath the dial. Messrs. Pell, Cahill, and Co. have introduced a reduction gear dial, the Pelican "Univernier," suitable for fitting to condensers and other components. An endeavour has been made by the Radio Communication Company to supply a reliable condenser at a really low price, and an entirely new form of construction is adopted consisting of a flat metal case, which serves as one plate of the condenser, and totally enclosing the moving plates which are forced outwards by a screw operated from the instrument knob.

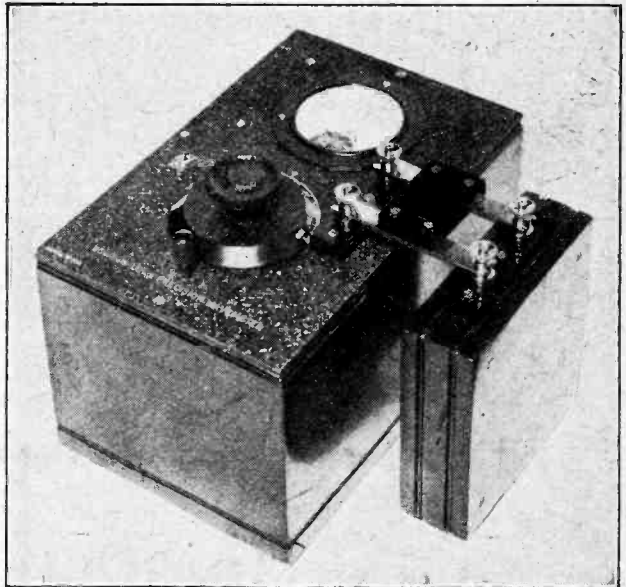

Bowyer-Lowe precision wavemeter fitted with interchangeable range coils and Weston thermo-ammeter to indicate resonance.

In the range of fixed condensers, the new C.A.V. unit condenser is of interest, for in a single component provided with a number of tags a capacity range of 0.0001 mfd. to 0.0015 mfd., or 0.001 mfd. to 0.015 mfd. can be obtained. The new A.J.S. fixed condenser is circular, easily attached to an instrument panel, or is sufficiently small to be carried on the wiring. The Dubilier Condenser Company have introduced a transmitting con-

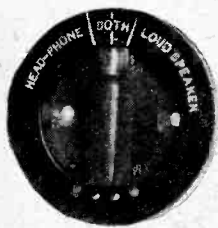

One of the several types of panel switches supplied by Gent & Co., Ltd.



C.A.V. receiving circuit condenser with which capacity values between 0.0001 and 0.0015 mfd. can be obtained in steps of 0.0001 mfd.

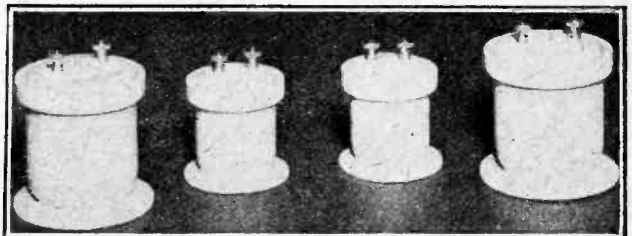

The new high tension condensers of the Dubilier Condenser Co., for use in amateur transmitting sets.

denser for use in amateur stations, filling a long-felt want, for hitherto no such component has been obtainable, while the construction of high-tension transmitting condensers by the experimenter is no easy task. This condenser is manufactured in various sizes, and is attractively finished with porcelain top and containing jar, the condenser units being clamped up in a metal ring.

Only a few intervalve low-frequency transformers of new design, offered as component parts, are to be seen, although most of the transformers fitted in the multi-valve receivers have been modified. The A.J.S. transformer is fitted with clips for a leak resistance across its secondary, and a primary bridging condenser is attached to the terminal plate. For resistance amplification the Mullard Radio Valve Co. have introduced a wire-wound anode resistance of standard dimensions and obtainable in values up to 100,000 ohms.

The London and Provincial Radio Co., as well as Hurst Bros. & Co., Ltd., are showing geared two-coil holders suitable for mounting behind the instrument panel.

Accessories.

Developments have taken place in the construction of accumulators for wireless purposes, and in particular the

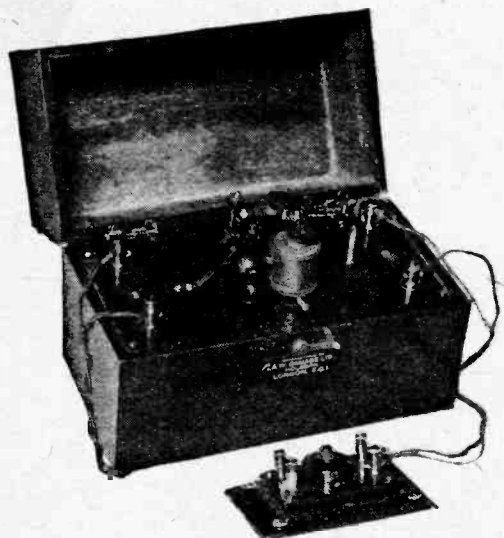

A. W. Gamage, Ltd., have introduced a remote control equipment for switching on the battery supply at a distance from the receiving set.

production of a high-voltage battery which will hold its charge for a period of six months is a feature of particular interest to users of multivalve sets. The "Exide" battery enclosed in a cellular glass box is of this type, whilst C. A. Vandervell and Co., Ltd., have also introduced a high-tension battery which is capable of giving six months' service without recharging.

Cabinets and carrying devices for high and low-tension batteries are to be found on several of the stands.

The range of valves is steadily increasing. Burndeft Wireless, Ltd., are now manufacturers of a complete series of valves for all purposes, their quality being endorsed by the fact that they are now supplied as standard on this firm's receiving equipment. The valves have been given reference letters and numbers which indicate both the purpose for which they are designed and filament

potential and current. In addition to the stand of the M.O. Valve Co., whose valves are well known, both the General Electric Co. and the Marconiphone Co., Ltd., are each exhibiting a series of pipless valves bearing respectively the names "Osram" and "Marconi." A dull emitter power valve is a new Mullard product having a filament of extremely high emissivity requiring only 0.1 ampere at 3.5 to 4 volts. Microphonic noises in this valve, which is styled the P.M.4, are eliminated by operating the filaments at an unusually low temperature. The British

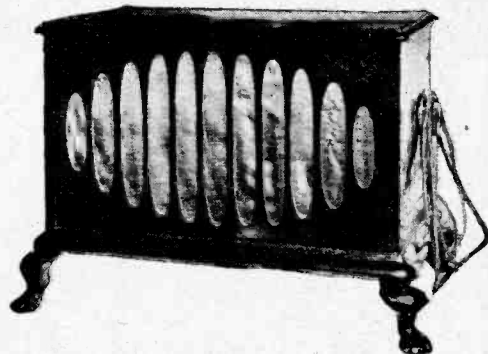

C.A.V. cabinet type loud-speaker. It is not a hornless model, but by enclosing the loud-speaker in an attractive cabinet the appearance is very much improved.

Thomson-Houston Co. are exhibiting six types of valves, three general-purpose and three power-amplifying. A full series of Ediswan valves may be seen, including bright and dull emitter types designed for H.F. and L.F. work, and power valves for use on 5, 3, and 2-volt circuits. The Cossor range of valves has been extended by the introduction of the type P.3, which is an addition to their loud-speaker series.

Several important developments have taken place in loud-speaker design. Messrs. Alfred Graham and Co., in addition to a complete range of their well-known Amplion loud-speakers, are showing the new "Radiolux" series, an entirely new and original form of loud-speaker, which in appearance closely resembles the familiar English bracket clock, giving full volume of reproduction comparing with that of the larger horn types. Two general types are available differing only in dimensions, each being obtainable in five different cabinet styles. The "Audalton," of the Radio Communication Co., is attracting considerable attention. This is a hornless model, in which the sound waves are set up by throwing into vibration a divided vertical cylinder some 14in. in height by a "drive" attached near the centre of one edge. The Sterling "Mellovox" is another new type of hornless loud-speaker.

NEW A.J.S. SHOWROOMS.

An event of considerable interest took place on Thursday, September 10th, when the London wireless offices and showrooms of Messrs. A. J. Stevens & Co. (1914), Ltd., were opened.

The principal guest at the luncheon was Prof. A. M. Low, and the visitors were received by Mr. Edward Lamb, the chairman of the company.

A letter from Sir Oliver Lodge, expressing appreciation of the results obtained from an A.J.S. four-valve set, was read by Mr. Lamb in the course of a speech, in which he outlined the wireless policy of the company.

EXPERIMENTAL VALVE UNIT.

An Instrument with Many Useful Applications in the Laboratory.

By G. G. BLAKE, M.I.E.E., A.Inst.P.

THE instrument illustrated and described in the following article should find many uses in the hands of the experimenter.

Amongst these it can be used as:—

- (a) An extremely sensitive electroscopie.
- (b) An intermediate unit between a wireless receiving set and a recording instrument to suppress the plate current in the spaces between the reception of signals.
- (c) A single-valve note magnifier.
- (d) The valve unit when carrying out experimental transmissions.
- (e) A detector for reception with or without reaction by means of external connections.

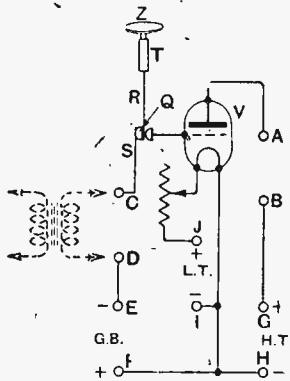

Fig. 1.—The unit connected as a valve electroscopie.

The instrument consists of a three-electrode valve, V, a rheostat, and five pairs of terminals. It is fitted with an ordinary valve holder, and valves of different types are employed according to the use to which it is desired to put the instrument.

Fig. 2 is a photograph of the instrument when used as an electroscopie.

For this purpose it is necessary to use a valve of low internal capacity and one in which the grid is very perfectly insulated. The Marconi QX is excellent for this purpose. It has an amplification factor of about 25, and the grid connection is brought out through the glass side of the tube, thereby ensuring very perfect insulation.

Special adaptors are obtainable for plugging into an ordinary valve holder, to carry this type of valve. Such an adaptor can be seen in Fig. 3 and in the photograph in Fig. 2.

Fig. 3 illustrates a QX valve in its adaptor. When the arrangement is to be employed as an electroscopie, the grid contact spring S is separated from the grid terminal of the valve by means of a sulphur insulator on the

end of a metal rod or stout wire, R, the lower end of which makes contact with G. The spring S pressing against the sulphur insulator Q grips the rod in position. At the upper extremity of R a socket, T, is fitted, on to which

(1) Connection can be made to an ionisation chamber when the instrument is to be employed for X-ray measurements;

(2) A flat plate, Z, can be placed when the instrument is to be used as a simple electroscopie;

(3) A radium-coated spiral, Y, can be fitted when the electroscopie is to be employed for obtaining measurements of atmospheric electrification or when demonstrating the passage of a cloud of ions from one side of a room to the other.²

Provided the radium spiral Y, or the plate Z, are sufficiently lightly constructed, the grip between the spring S and the grid terminal of the valve provides sufficient support. In the instruments shown in the photograph in Fig. 2 an extra support is provided by means of a wooden rod capped by a second sulphur insulator.

(4) In the place of radium spirals the flame of a small methylated spirit lamp, L, as illustrated in Fig. 3, can be employed to ionise the atmosphere.

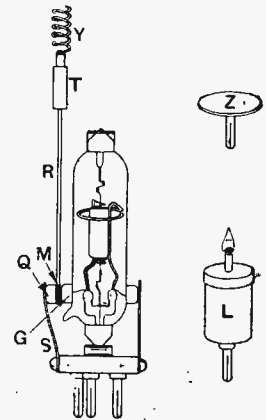

Fig. 3.—Adaptor for use with the valve electroscopie. The metal disc Z, or the methylated spirit lamp L, may be substituted for the radium spiral.

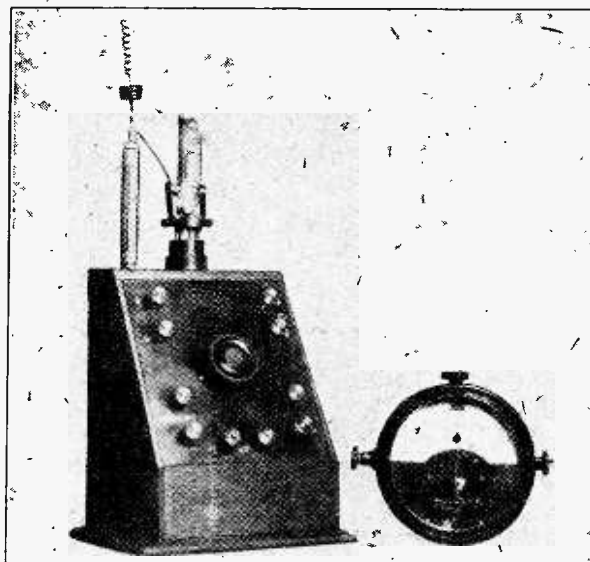

Fig. 2.—General view of instrument. The radium-coated spiral is supported on an insulated pillar to give additional strength.

Connections for Use as an Electroscopie.

Terminals A and B are connected either to a milliammeter, a reflecting galvanometer, or a siphon recorder.

An H.T. battery is connected across terminals G and H to supply the plate current as indicated. A low-tension battery is connected across terminals I and J.

¹ Radium-coated spirals can be obtained from F. Harrison Glew, 156, Clapham Road, Clapham, London, S.W.

² See *The Wireless World* of June 11th, 1924.

Experimental Valve Unit.—

Rod R is placed in position and makes contact with the grid terminal of the valve, at the same time insulating it from the spring S.

The instrument will then function as an extremely delicate electroscopes or electrostatic voltmeter, and is more sensitive by far than a gold leaf electroscopes.

The slightest voltage, whether applied directly or in-

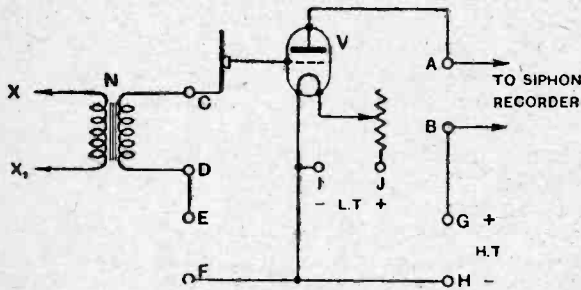

Fig. 4.—Connections for use as an intermediate unit between a receiver and a recording instrument.

directly, to the grid of the valve will cause a corresponding variation in the plate current indicated in the milliammeter or reflecting galvanometer. The latter can be calibrated to show voltage readings.

The sensitivity can be increased (a) by the use of a reflecting galvanometer in place of the milliammeter, or (b) by the addition of several stages of valve amplification.

Recording Circuits.

The circuit arrangement is shown in Fig. 4. The primary of an iron-cored transformer, N, is included in the plate circuit of the last valve of the receiving set in

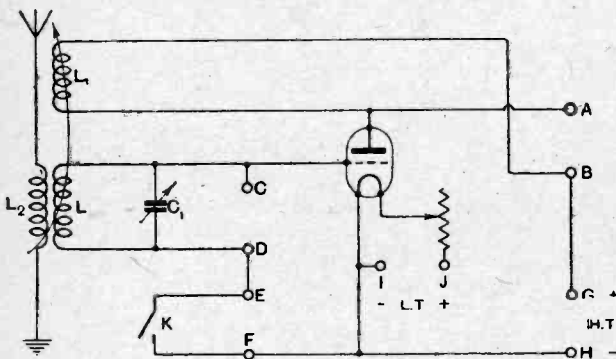

Fig. 5.—External connections necessary to convert the unit to a low-power transmitter.

place of the loud-speaker, and its secondary windings are connected to terminals CD.

A "siphon recorder" or other type of recording instrument is connected to terminals A and B in the plate circuit of the valve V. A valve of the B.T.H. B4 or similar type is excellent for the purpose.

The current for the circuit is supplied from an H.T. battery connected across terminals G and H. An adjustable grid bias battery is connected across terminals E and F, and a sufficient voltage is applied to ensure that

the valve will function at the bottom of its characteristic curve. Under these conditions the grid is sufficiently negative to completely hold up the passage of the plate current, except when positive voltages are impressed upon the grid from the secondary of the transformer N during the actual reception of the dots and dashes.

Note Magnifier.

The connections are the same as those shown in Fig. 4, but in this case a suitable grid bias should be given to ensure that the valve shall function on the straight portion of its characteristic curve.

A loud-speaker would, of course, in this case take the place of the "siphon recorder" between terminals A and B.

Low-power Transmission.

Many arrangements of connections may be made for small power transmissions. One example is given in Fig. 5.

An open-circuit aerial system is employed, and the inductance L2 is coupled to a closed circuit tuning inductance, L, tuned by a variable condenser, C1, and connected across terminals C and D.

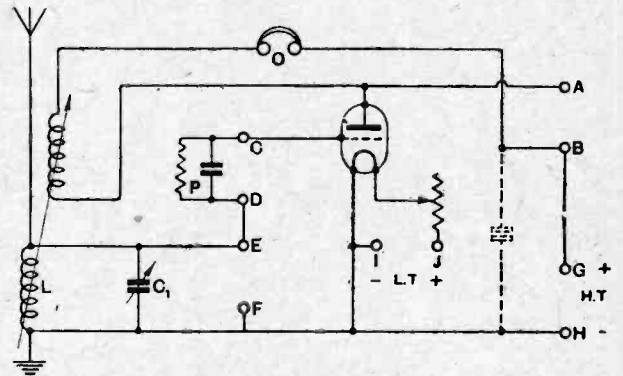

Fig. 6.—Unit arranged as a single valve receiver with reaction.

I1 is a reaction coil connected across terminals A and B and reacting on to L.

K is a Morse key which completes the grid circuit between terminals E and F.

Reception.

Various receiving circuits can be connected to the unit, and one such circuit is shown in Fig. 6.

L is the A.T.I. tuned by means of variable condenser C1; L1 a reaction coil in series with telephones O as shown.

A condenser of about 1 mfd. should also be connected across terminals A and H. A grid leak and condenser, P, are connected across terminals C and D.

There are doubtless many other purposes to which the multi-purpose unit could be put, such as the plotting of characteristic curves, the carrying out of various electrical measurements, the operation of a relay, etc.

No doubt many other uses will in practice present themselves to the experimenter.

A
Simple Receiver
for the
Beginner.

This set is suitable for reception both with telephones and a loud-speaker, and gives experience in tuning for quality with loud signals and for sensitivity on distant stations.

By

F. VAN NECK.

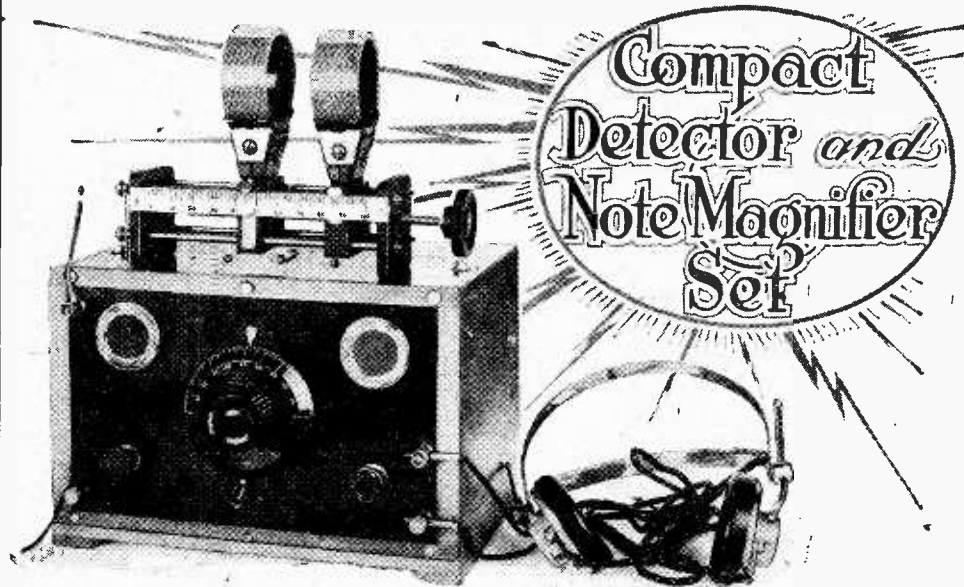

A TWO-VALVE receiver consisting of a detector valve with reaction and a single note magnifier forms an excellent subject for the beginner who may be contemplating for the first time the construction of a valve receiver. A set of this description presents few constructional difficulties, and if assembled and wired according to the instructions which follow, can be relied upon to give good results from the moment the valves are switched on for the first time.

The operation of a set of this type is particularly instructive to a beginner. Loud-speaker results can be obtained with an outdoor aerial within a radius of 10 miles of any of the main B.B.C. stations, while the range when using telephones is limited only by the skill of the operator; indeed, this circuit is adopted by many of the leading amateurs in this country for the reception of amateur transmissions from America and the Antipodes. Thus practice is obtained in tuning for good quality on loud signals, and also for sensitivity on distant signals.

The Circuit.

Referring to Fig. 1, it will be seen that the aerial circuit is tuned by means of a plug-in coil and a 0.0005

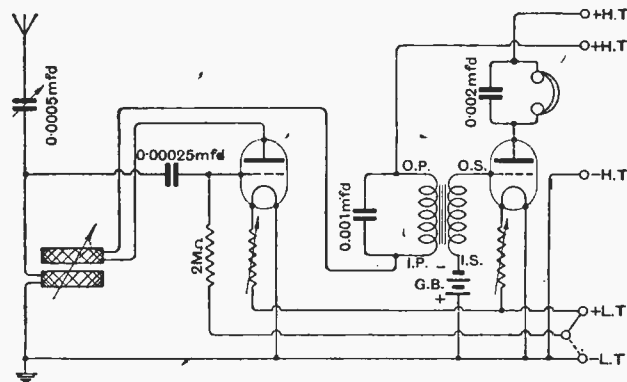

Fig. 1.—The circuit diagram.

mfd. variable condenser in series with the aerial. When signals are received on the aerial an E.M.F. is set up across the ends of the plug-in coil, which is transferred to the grid and filament of the detector valve. In order that the valve may function efficiently as a rectifier, a grid condenser of 0.00025 mfd. and a grid leak of 2 megohms are connected in the grid lead. The filament end of the 2 megohm grid leak is connected to a terminal midway between the +L.T. and -L.T. terminals. Thus by means of a short-circuiting link the lower end of the resistance may be connected to a point of either positive or negative potential. The sensitivity and consequently the effective range of the receiver are increased by the use of reaction.

Reaction.

The second plug-in coil connected in the anode circuit of the detector valve is coupled to the aerial coil for this purpose, and it not only increases the range but also diminishes the effective resistance of the aerial circuit, and so improves selectivity. The use of reaction is perhaps the best known method of increasing selectivity, and it is as well that the beginner should familiarise himself with its manipulation at an early stage. Connected also in the anode circuit of the detector valve is the primary winding of the intervalve transformer, which passes on the low-frequency telephonic currents to the amplifying valve. Since alternating currents of both high and low frequency are circulating in this anode circuit, it is necessary to connect a by-pass condenser of 0.001 mfd. across the primary winding in order to prevent the passage of H.F. currents through the turns of the primary coil. The effect of this condenser is to improve greatly the smoothness with which reaction takes place, and to a certain extent to protect the insulation of the windings. The secondary winding of the transformer is connected between the grid and filament of the amplifying valve, a small battery of from 1½ to 4½ volts being connected in series to maintain the grid of the amplifying valve at

Compact Detector and Note Magnifier Set.—

a normal negative potential. The exact voltage of this battery will depend upon the type of valve and the value of H.T. employed, and may be obtained from the list of data now almost universally supplied with valves. The telephones or loud-speaker are connected in the anode circuit of this second valve, and are shunted with a 0.002 mfd. condenser to improve the quality of reception. Two terminals are provided on the terminal board for separate H.T. tapings to the detector and amplifying valves.

Components.

The coil holder should be of a type giving minute control over the coupling between the coils. Cheap coil

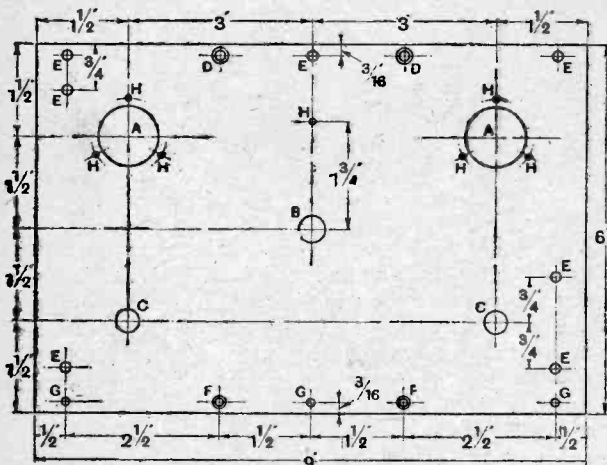

Fig. 2.—The front panel. Drilling details are as follow: A, 1in. dia.; B, 7/16in. dia.; C, 3/8in. dia.; D, 5/32in. dia., countersunk for No. 4 B.A.; E, 5/32in. dia.; F, 1/8in. dia., countersunk for No. 4 wood screws; G, 1/8in. dia.; H, 3/32in. dia.

holders should be avoided, as their action is seldom smooth, and they cannot be relied upon to keep the coupling fixed.

The variable tuning condenser is fitted with a vernier adjustment, which the beginner will find very useful in obtaining a fine adjustment of tuning. Any good make of intervalve transformer may be employed, and a general-purpose type having a ratio of 1:4 or 1:5 should be chosen.

The filament resistances used in this receiver are of the

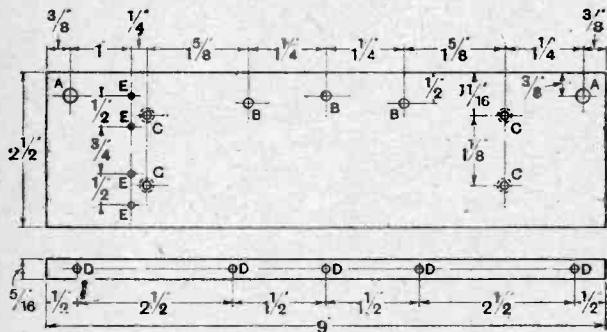

Fig. 3.—The coil holder shelf. Diameters of holes are as follow: A, 7/32in. dia.; B, 5/32in. dia.; C, 1/8in. dia., and countersunk for No. 6 B.A.; D, 7/64in. dia., and tapped 1/2in. deep for No. 4 B.A.; E, 3/32in. dia.

B 14

compression type, which are equally suitable for bright or dull emitter valves. This type has a wide resistance range, and is very smooth in action.

The valve holders actually used in this set were home-

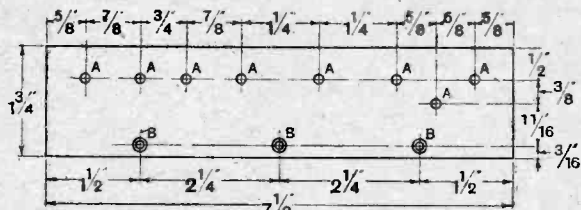

Fig. 4.—Terminal panel. Diameters of holes are as follow: A, 5/32in. dia.; B, 1/8in. dia., and countersunk for No. 4 wood screws.

made, but the design is very similar to the "Magnum" valve holders, which may be substituted if desired.

Assembly.

The framework of the receiver is built up of four parts—the wooden baseboard, a main front panel, a top panel for the coil holder, and a terminal strip at the back of the baseboard. Drilling details of these panels are given in Figs. 2, 3, and 4, and the method of assembling them together is clearly indicated in the photograph (Fig. 8).

Before finally fitting together the panels, those components which are mounted on the baseboard are screwed in the positions indicated in Fig. 5. The front panel and terminal strip are then screwed to the front and back edges of the board, and finally the top panel for the coil holder is fitted to the front panel with screws in the holes

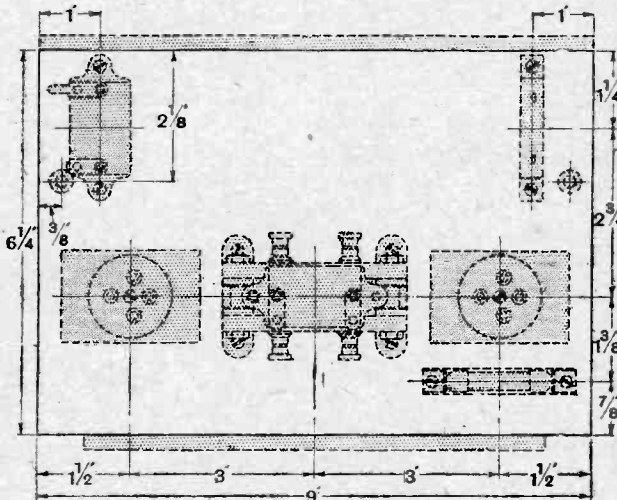

Fig. 5.—Layout of components on the base.

D in Fig. 3. The top panel is supported by two pillars which consist of an outer sleeve of ebonite tubing 1/4 in. in diameter, through the centre of which passes a No. 2 B.A. screwed rod. The baseboard is recessed underneath to take the lock nuts for these supports, which pass through the coil holder shelf and carry lock nuts on the top. The variable condenser, filament resistance and terminals may now be fitted to the front panel and the coil holder to the top panel, when the set will be ready for wiring.

**Compact Detector and Note
Magnifier Set.—**

Wiring.

Every attempt has been made to reduce as far as possible the length of wiring in the receiver. For instance, it will be noticed in Fig. 6 that the grid condenser and leak have been placed in close proximity to the grid of the detector valve. Again, the by-pass condenser has been mounted directly on top of the intervalve transformer, so that the soldering tags may be bent over and clamped in the terminals of the primary winding. The telephone condenser is placed on the baseboard immediately below the telephone terminals. A complete layout, showing the position of the wires, is given in Fig. 7. The coil holder is not shown, but the connections to it are indicated by arrows at the extreme left of the diagram.

Cabinet

The cabinet was specially made to fit the set, as the arrangement of the coil holder on a separate panel at the top renders impracticable the use of the standard cabinets which are obtainable from retailers of wireless components.

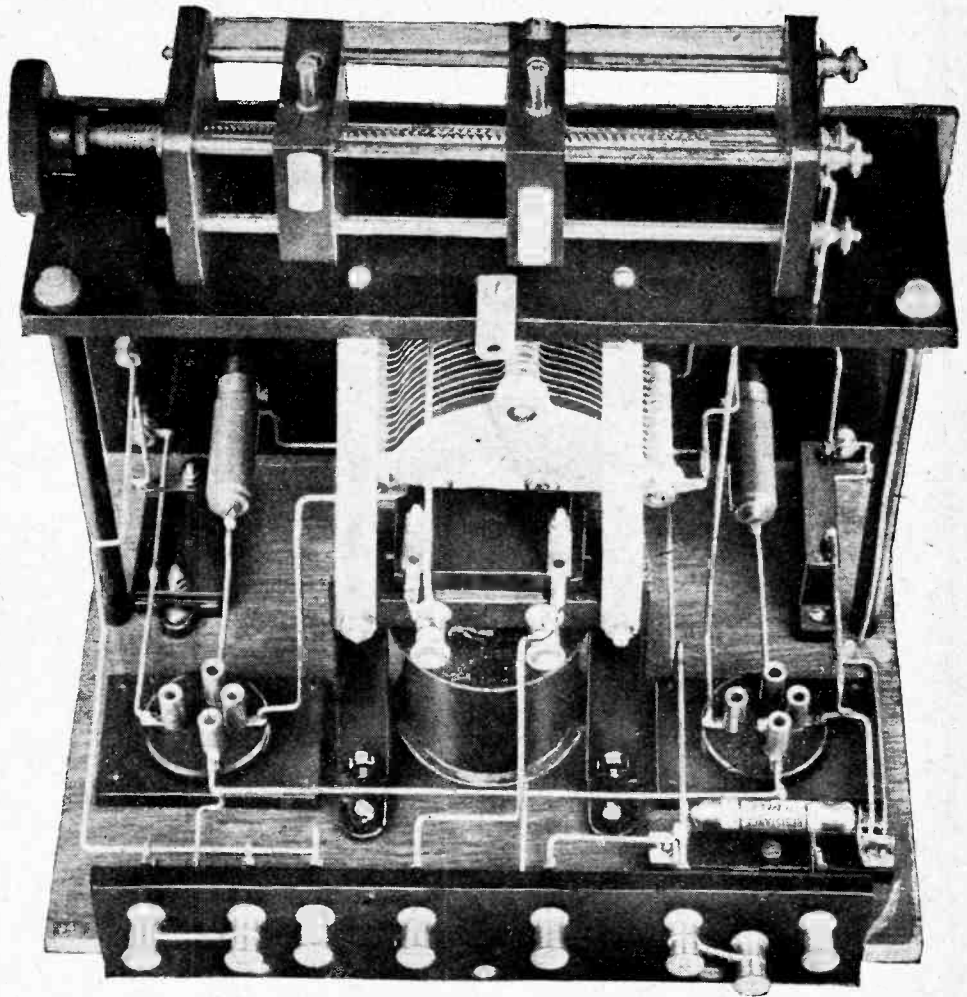

Fig. 6.—Rear view of the finished set, showing the position of the by-pass condenser and brass supports on top of the intervalve transformer.

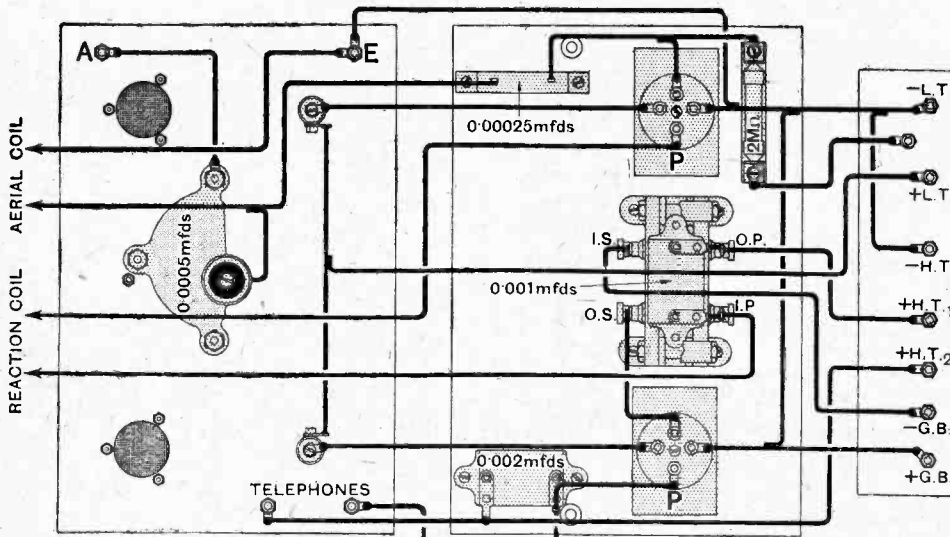

Fig. 7.—Complete wiring diagram. The four leads on the left-hand side of the diagram are connected to the coil holder.

The back of the cabinet is cut away to fit the terminal strip, and the ebonite block seen at the right-hand side of the cabinet is a guide which prevents the baseboard from tilting up when the set is being inserted in the cabinet. A small peg on the top of the cabinet engages with a spring catch on the coil holder shelf to hold the set in position. If desired, the cabinet may be raised on two narrow battens as indicated in the diagram.

It is interesting to note that with the top of the cabinet cut away to fit the coil holder shelf, it is only necessary to withdraw the set partly from the cabinet in order to insert or withdraw

Compact Detector and Note Magnifier Set.—

valves, and there is no necessity to disturb any of the connections to the terminal strip.

Choice of Valves.

If the reader has not had any previous experience with the manipulation of valve receivers, the use of bright emitter valves is strongly recommended. Valves of the A.R. or R.5.V. type will give excellent results in this receiver, and if the filament resistances are turned on a little too far, the emission from the filaments will not be affected unless the valve is actually burnt out. Having become familiar with the operation of the receiver and the effects upon reception of various filament and H.T. voltages, the amateur may safely substitute dull emitter valves. If any choice is allowed, valves of the D.E.R. type are recommended, taking approximately 0.3 amp. at 2 volts. These valves are much more robust than many other types which are even more economical in filament current.

Testing and Operation

Assuming that R.5.V. type valves are being employed, a 6-volt accumulator should be connected to the L.T. terminals, and a H.T. battery of about 75 volts should

be connected between - H.T. and + H.T.2. A tapping at 36 volts should then be taken to + H.T.1.

The first tests may be made with the grid bias terminals short-circuited, and with the grid leak connected to - L.T. Having connected the aerial, earth, and telephones, the

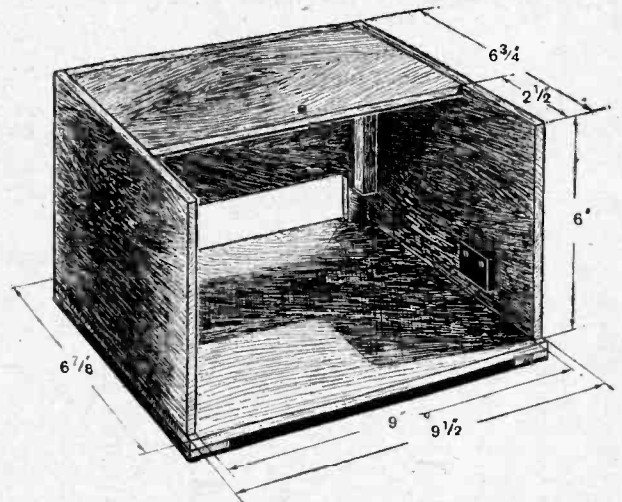

Fig. 9.—Leading dimensions of the cabinet. The rectangular hole at the back is cut to fit the terminal strip after the set has been completed.

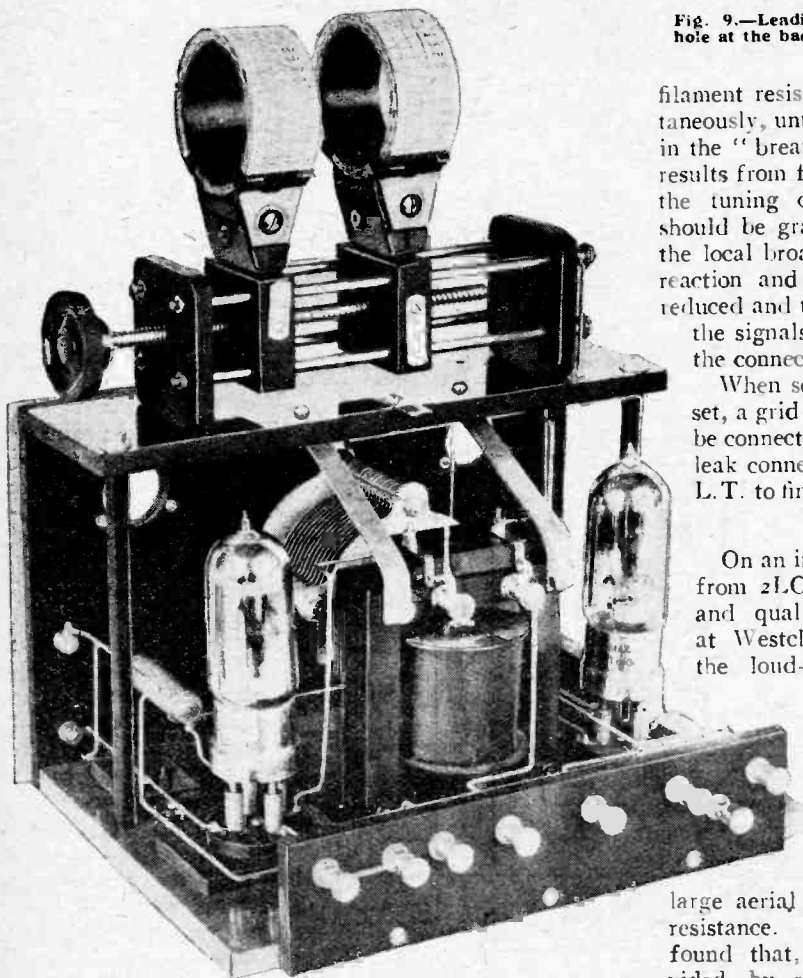

Fig. 8.—Complete receiver ready for insertion in the cabinet.

B 16

filament resistances should be gradually turned on simultaneously, until a point is reached when no further increase in the "breathing" noises, caused by atmospheric, etc., results from further increase of the filament current. With the tuning coil well separated, the tuning condenser should be gradually turned until signals are heard from the local broadcasting station. The distance between the reaction and the aerial coils should now be gradually reduced and the effect on the signal strength observed. If the signals decrease as the coils approach one another, the connections of the reaction coil must be reversed.

When some practice has been obtained in tuning the set, a grid bias battery consisting of two dry cells should be connected across the grid bias terminals, and the grid leak connection should be tried to both minus and plus L.T. to find which gives best results.

Results.

On an inefficient indoor aerial at Wembley the signals from 2LO are sufficiently loud to give good volume and quality from a full-sized loud-speaker, while at Westcliff-on-Sea, Daventry has been received on the loud-speaker, and Bournemouth, Birmingham, and 2LO at loud telephone strength. Here again the aerial was of the indoor type, so that with a good outdoor aerial no difficulty should be experienced in receiving most of the B.B.C. and Continental broadcasting with telephones.

The higher and longer the aerial, the louder will be the signal strength, but a large aerial often has a proportionately higher effective resistance. Near one of the B.B.C. stations it may be found that, in spite of the additional selectivity provided by reaction, interference is experienced. The obvious remedy is then to reduce the length of the aerial.

Broadcast Brevities

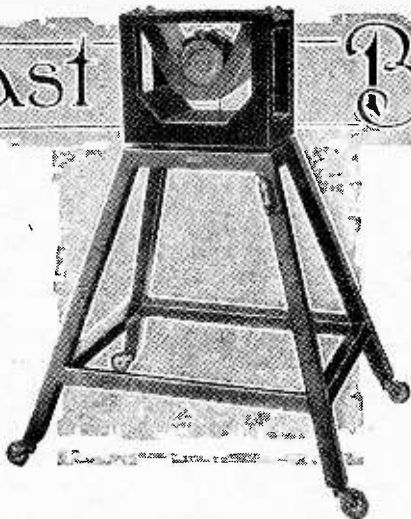

SAVOY HILL

Wavelength Tests.

The efficiency of the arrangements for conducting tests on the special wavelengths allocated to British stations by the Geneva conference of broadcasters was amply proved during the first two or three nights of the tests. Whereas nearly four hundred letters reporting interference were received from listeners when the tests started, the number dropped to less than four score after certain re-arrangements had been carried into effect. These changes took place in the wavelengths of some Continental stations which at the outset were found to be jamming B.B.C. stations.

o o o o

Interference.

One unfortunate effect of the experiment was that a sudden spasm of heterodyning by foreign stations was apparent prior to the beginning of the tests. This was attributed to the fact that the stations in question got off their wavelengths in order to try the new wavelengths for the test, and then failed to return to their regulation wavelengths with sufficient accuracy. Both British and foreign stations experienced a good deal of trouble; in one case a Middlesbrough listener reported Rome heterodyned by Stockholm two days before the tests. In this way the transmissions of four British stations were seriously impeded. The experiences collated for the Geneva Conference in a week's time will make interesting reading.

o o o o

An Important Broadcast.

Several important members of the Government will speak at the Birmingham and District Civil Servants' Dinner on October 24th. The speeches will be relayed to 5XX.

o o o o

Leeds Sub-station.

The opening of a sub-relay station at Leeds for amplifying and purifying certain S.B. transmissions before broadcasting to local listeners will raise the status of Leeds in broadcast history. The Leeds-Bradford station already occupies an exceptional position in the broadcasting system; for, although it figures as one station it counts as two stations operating on different wavelengths.

o o o o

The Transmitter.

The transmitter at Leeds, which is of the standard 200-watt relay type, is situated at the Corporation Destructor at Stanley Road, and the aerial is of the usual multi-wire type, spaced on large

TOPICALITIES.

circular hoops. The system is suspended in the usual manner from the top of the destructor chimney.

o o o o

Bradford Apparatus.

The Bradford arrangements are almost identical, the aerial being made fast to a tall chimney in Simes Street, while a separate transmitting outfit is installed in the vicinity.

o o o o

The Control Room.

The two stations are connected by telephone lines to the control room at Basinghall Street, Leeds, where also terminate the London trunk wires. By duplicating the switching arrangements and providing for the splitting of the telephony at Leeds, it is possible to conduct efficient broadcasting from both aeri-als on slightly different wavelengths.

o o o o

A Clean Record.

Good accounts have been received concerning the behaviour of both stations as observed in many distant parts, and it is recalled that the recent successful broadcast from York Minster, as well as the first broadcast in this country from a coal mine, was carried out *via* Leeds.

o o o o

Accidents Will Happen.

Few B.B.C. stations can record any incident savouring of real disaster, as the mishaps, generally of a minor character, are concerned mainly with natural causes and are quickly overcome by ingenious emergency contrivances which engineers seem consistently capable of rigging up. One mishap at Glasgow, however, minor though it was in character, had its amusing side, and is enshrined in the records for use when a fuller history than any that has yet been attempted of the B.B.C. comes to be written.

o o o o

At Glasgow.

This incident occurred on one occasion when, having sent the spare microphone post haste to London for repairs, one only was left in the studio; and it happened on that fateful evening that the microphone required to be moved. The pedestal on which is rested shed one of its beautiful carved legs without warning, and this act of contrariness was unnoticed by the person about to make the next announcement. As the pedestal was being moved to its new position it refused to stand on its remaining three legs. The microphone was consequently shot into a far corner of the studio, after having struck several obstacles on its way; and as the

FUTURE FEATURES.

Sunday, September 20th.

LONDON.—3.30 p.m., Star Ballad Concert. 9 p.m., H.M. Grenadier Guards Band.

BIRMINGHAM.—3.30 p.m., Classical Favourites.

GLASGOW.—9 p.m., "Requiem" (Brahms).

Monday, September 21st.

LONDON.—8 p.m., "Faust" (Gounod), Acts. II. and III., relayed from the Theatre Royal, Leeds.

Tuesday, September 22nd.

5XX.—9.15 p.m., "Radio Radiance."

LONDON.—8 p.m., Symphony Concert, conducted by Sir Hamilton Harty.

ABERDEEN.—8 p.m., Music of the Elizabethan Period.

Wednesday, September 23rd.

LONDON.—8 p.m., "Autumn".

CARDIFF.—9.20 p.m., "In a Persian Garden" (Liza Lehmann).

BELFAST.—7.30 p.m., Symphony Concert, conducted by Julius Harrison.

Thursday, September 24th.

MANCHESTER.—8 p.m., Symphony Concert.

Friday, September 25th.

LONDON.—8.20 p.m., Musical Extravaganza, "Winners," No. 2. 10.15 p.m., Charles Coborn.

GLASGOW.—8 p.m., Annual Gaelic Concert, relayed from the Town Hall, Greenock.

Saturday, September 26th.

LONDON.—8.45 p.m., "I Pagliacci" (Leoncavallo), relayed from the Theatre Royal, Leeds.

BIRMINGHAM.—8 p.m., Radio Fantasy, No. 8, "Comeos of Egypt."

BOURNEMOUTH.—8 p.m., Feature Programme. S.B. to 5XX.

power happened to be on, the station was automatically closed down amid considerable excitement. Fortunately it was found, on examination, that the microphone was none the worse for its adventure and order was soon restored.

o o o o

An Important Outside Broadcast.

One of the most interesting of outside broadcasts in the coming weeks will be that of the Forum Club Dinner on October 1st. The speakers will include Mr. T. P. O'Connor, M.P., Miss Rebecca West, Sir Philip Gibbs, who has carved his way to fame both as novelist and war correspondent, and Dr. Michael Sadler. Although such an event does not figure as an educational broadcast, the quality of the speakers fully entitles it to rank as such.

o o o o

Morse.

Sooner or later a co-ordinated attempt will be made by the various European Governments to tackle the question of Morse interference, and in this connection the rules recently issued by the French Government in the form of a Decree are of interest. They relate to territorial waters, and are to the effect that outside the harbours and roads the use of pure non-modulated C.W. is free. The use of other waves is subject to general precautions for avoiding interference, their limitation in point of time to a period that is strictly necessary and no longer, etc.

o o o o

Restrictions.

The 600-metre wave is reserved for distress signals and the 900-metre wave for the use of aircraft. Wireless in harbour is practically forbidden, and wireless by men-of-war and military aircraft is restricted. Merchant aircraft may use W.T. for their safety, or for the require-

ments of their voyage only. Inside naval harbours merchant vessels may not use their wireless apparatus at all, except for test, for which purpose permission must first be obtained. It is of importance that in the area surrounding Great Britain, Cherbourg and Brest only will come within the list of naval harbours; but as the French have thus tightened up the rules for spark transmissions inside the three-mile limit it is suggested in some quarters that this country has very great justification for doing the same.

o o o o

Too Much of a Good Thing.

The broadcasting of several music recitals recently from the Haslemere Festival evoked severe criticism among listeners who are not so enamoured of chamber music as to tolerate an overdose of that kind of entertainment.

Now, it is admitted that only a certain section of the music-loving public finds a strong appeal in chamber music, which is not the brightest kind of music, and perhaps is not appreciated by the majority of listeners; but in respect of the performances at the Haslemere Festival it was considered that these had an educational value which commended them for broadcasting, and justified the B.B.C. in its intention to try and popularise them.

o o o o

Future Policy.

Listeners may, however, rely on the B.B.C. not to overdo the educational side of music transmissions. There is no criterion by which the acceptability or otherwise of a particular kind of programme may be judged other than the opinion of listeners themselves; nor is there any wish to force upon unwilling ears too much music of the sort that is understood and appreciated only by the minority. The one true policy is to cater

as far as possible for all tastes. At present this policy suffers a handicap because of the limited facilities for providing alternative programmes; but the B.B.C. hopes to be able at some future time to avoid criticisms such as those promulgated in connection with the Haslemere Festival by broadcasting "high-brow" music and speech separately and independently of the popular style of entertainment. Indeed, a considerable part of the Company's revenue will be devoted to that purpose.

o o o o

The Prince.

It is hoped that arrangements may be made to broadcast a speech by the Prince of Wales at a public function within the next month or two.

o o o o

A Mishap at Liverpool.

Trouble recently befell the antennae system at the Liverpool station. During a high wind the steel halyard which supports the main aerial wires fractured and the carefully constructed aerial device moved rapidly earthwards. This was an event as mystifying as it was unexpected, because the steel halyard had previously passed with distinction a rigorous breaking test of many tons. More interesting still was the fact that the afternoon transmission was about to commence. The curtain is drawn by the engineers over the subsequent proceedings; but they tell me that a period of thirty-five minutes was sufficient to allow them to make fast an improvised aerial.

o o o o

How it Happened.

The reason for such an extraordinary happening was afterwards discovered to be the peculiar eddy caused by the wind when blowing at a certain velocity. This caused the steel halyard to whip against the brickwork of the chimney and so become gradually cut.

ATMOSPHERICS.

Cherbourg Harbour is being fitted with a loud-speaker which can be heard over a distance of thirty miles. This instrument must be nearly as ear-splitting as that of our neighbour.

o o o o

During the broadcasting from Glasgow of the Cowal Highland Gathering, listeners heard the various incidental sounds connected with the games. Temporary deafness is said to have been caused in certain cases by the continuous popping of corks.

o o o o

By the careful application of condensers and resistances across the output, the engineers at the Hayes receiving station will be able to "tone down" the drums and trombones of KDKA. Certain listeners are said to be asking for a high-resistance saxophone eliminator.

o o o o

During preparations for the army manoeuvres a pack mule kicked a wireless set to pieces. It is understood that no safety switch had been fitted.

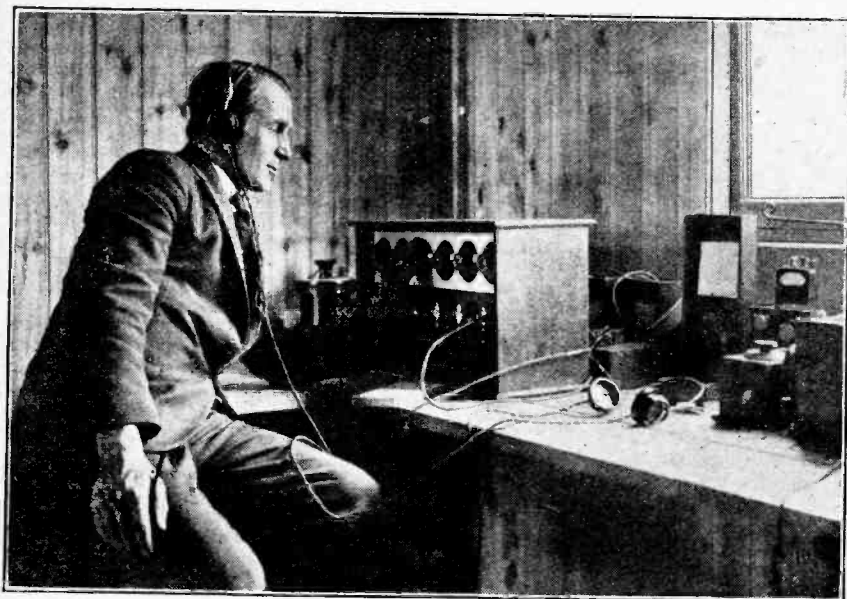

B.B.C. STATION AT HAYES. A corner of one of the operating huts, showing an engineer tuning-in on a multi-valve receiver.

H.F. AMPLIFIER DESIGN.

Practical Details of a Successful Receiver.

By G. W. SUTTON, B.Sc.

WITH a reasonably efficient aerial and earth system two stages of H.F. amplification will in general ensure the reception, if suitable valves and efficient design are employed, of all that is sufficiently above the prevailing level of atmospherics to be worth receiving at wavelengths not less than about 200 metres.

Methods of Stabilising H.F. Amplifiers.

The methods which may be employed to ensure stability can be conveniently classed under the following headings:—

- (a) The separation, as far as possible, of coils and leads, particularly those portions at high H.F. potential (*i.e.*, those connecting directly to the anode and grid of each valve), and arrangement of components to reduce magnetic coupling, with or without one or more of the succeeding devices.
- (b) The arrangement of successive grid and anode coils to produce negative magnetic reaction.
- (c) The provision of negative capacity reaction (*i.e.*, the so-called "neutrodyne" system).
- (d) Loose coupling between primary and secondary of H.F. transformers.
- (e) The introduction of resistance or its equivalent in the oscillatory circuits (*i.e.*, the use of a potentiometer, variable, or fixed resistors, etc.).
- (f) Detuning alternate circuits.
- (g) Using a preponderance of capacity in the tuned circuit.

Of these, after testing and comparing their advantages and drawbacks, the writer has found that (a) in combination with (c) and (d) provides the most satisfactory coupling from the point of view not only of stability but also of selectivity.

Many experimenters consider that (e) in one of its several forms is preferable to (c) for balancing out the effect of stray capacity reaction, on the grounds of greater certainty of operation. It is true that some forms of the

neutrodyne connection are difficult to adjust in the first instance, particularly to those unaccustomed to the vagaries of A.C. bridges; but the construction outlined below was adopted because of the certainty with which satisfactory operation could be obtained. There is no doubt of its greater efficiency when once adjusted.

Many circuits have been described from time to time which employ the method (f). The main drawback to this is inefficiency, which entails the

use of more valves and a more bulky and expensive set.

The tendency of a valve to oscillation is reduced by employing larger condensers and smaller inductances in the tuned circuits. Such an arrangement is also more selective, since the damping effect of the valve impedance is less. The wave-band, which can be covered with stability and efficiency with a given set of coils, is very narrow, however, and this is the main disadvantage of (g).

Method (b) was rejected after some experiments because of the precision with which the position of the coils had to be adjusted. A very slight movement, such as could easily result from plugging in a coil, was found to be sufficient to cause either over-stabilisation and consequent inefficiency, or self-oscillation.

The circuit arrangement and coupling components described below were, therefore, designed with the object firstly of reducing stray magnetic coupling to an absolute minimum; secondly, of reducing the tendency to oscillation by providing a loose coupling between primary and secondary windings of the H.F. transformers; and,

thirdly, of balancing out any stray capacity coupling by the neutrodyne method.

It should be remembered that negative capacity coupling as ordinarily arranged will not balance out the effect of stray magnetic coupling. This is probably the reason why many people have failed to stabilise neutrodyne amplifiers; their coils happen to be so arranged that oscillation is set up by stray magnetic coupling, quite apart from the stray capacities which it is the purpose of the method to deal with.

In the first part of this article attention was drawn to the fact that the stability of an amplifier could be profoundly modified by stray couplings, both electrostatic and electromagnetic, between valves, and a short experiment illustrating the magnitudes involved in both effects was described. The writer has experimented with most of the simpler methods of controlling these strays and proposes now to describe what he has found to be most effective.

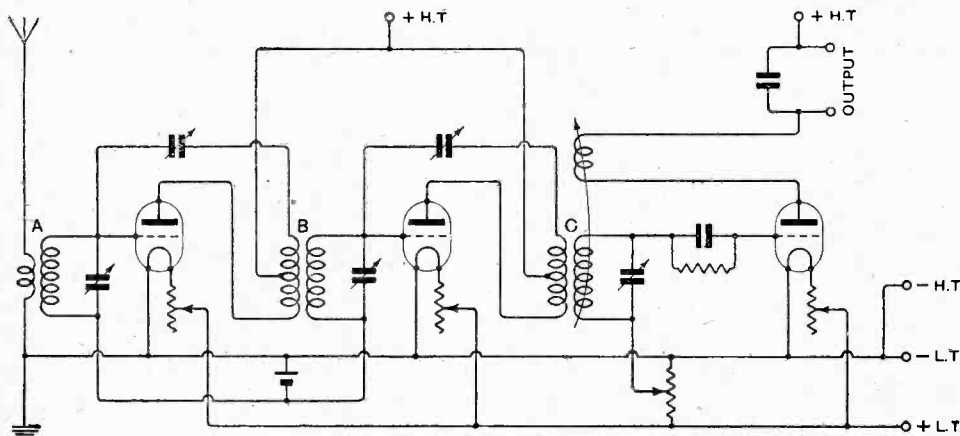

Fig. 1.—Circuit connections of the amplifier, which comprises two H.F. stages with balanced coupling, followed by a detector with reaction.

H.F. Amplifier Design.—

Fig. 1 illustrates the circuit employed in these experiments. It will be seen that there is nothing original in the theoretical arrangement of the circuit. This and other methods of applying negative capacity coupling to the grids of the amplifying valves have frequently been described and explained in this journal, and it will, therefore, be unnecessary to discuss the principles in-

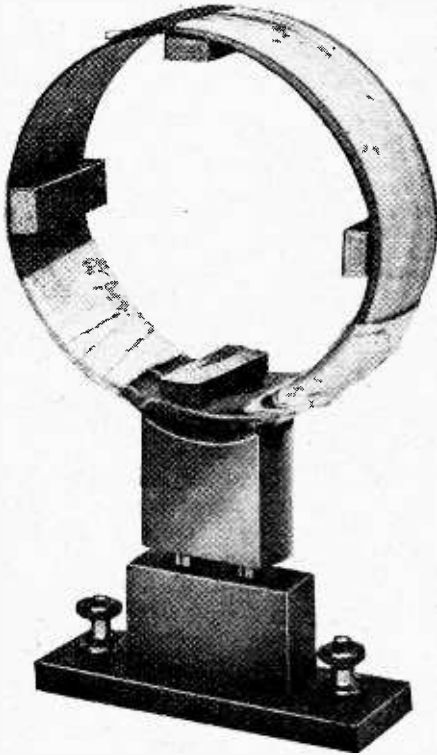

Fig. 2.—Secondary winding of one of the transformers, showing plug-in connections and ebonite supporting blocks for the primary coil.

involved. Satisfactory operation is a matter of practical detail.

Construction of the Coupling Coils.

To comply with the first requirement mentioned above the three coils A, B, and C are mounted with their centres on a horizontal line and their planes mutually perpendicular. A convenient arrangement is illustrated in the photograph (Fig. 5). The distance between the centres of the coils is 8 in.

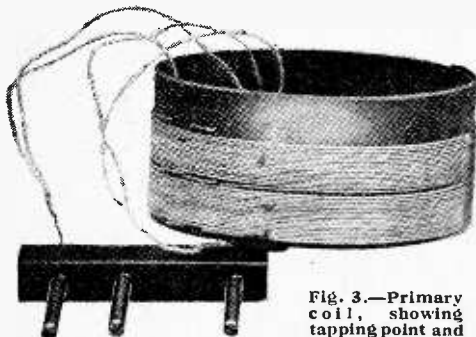

Fig. 3.—Primary coil, showing tapping point and pin connections.

Coil A consists of a 15-turn primary and a 35- to 40-turn secondary wound side by side in a single layer on a cylinder made from a strip of

"leatheroid." The cylinder was made 3 in. in diameter, and as No. 28 S.W.G. D.C.C. wire was used, the single layer of about 47 turns occupies 1½ in. The number of turns on the secondaries of the three coils is adjusted to give equal condenser readings for some particular wavelength. This is a great convenience when tuning to distant stations. When wound, the cylinder is mounted on an ordinary coil plug, the ends of the secondary being connected to the pin and socket, while two valve-pins are soldered to the ends of the primary and make connection to suitably mounted valve sockets.

The transformers B and C are similar to each other. In order to ensure the correct magnitude and phase of the neutralising potential to be supplied to the grid, it is as well to adopt the scheme illustrated in Fig. 1 in preference to connecting the neutralising condenser to a tapping on the secondary. The writer has frequently found it a matter of great difficulty to obtain a satisfactory balance with the latter method of connection, whereas the only trouble he has experienced with the former has been due to the use of a neutralising condenser either too small or too large for the purpose.

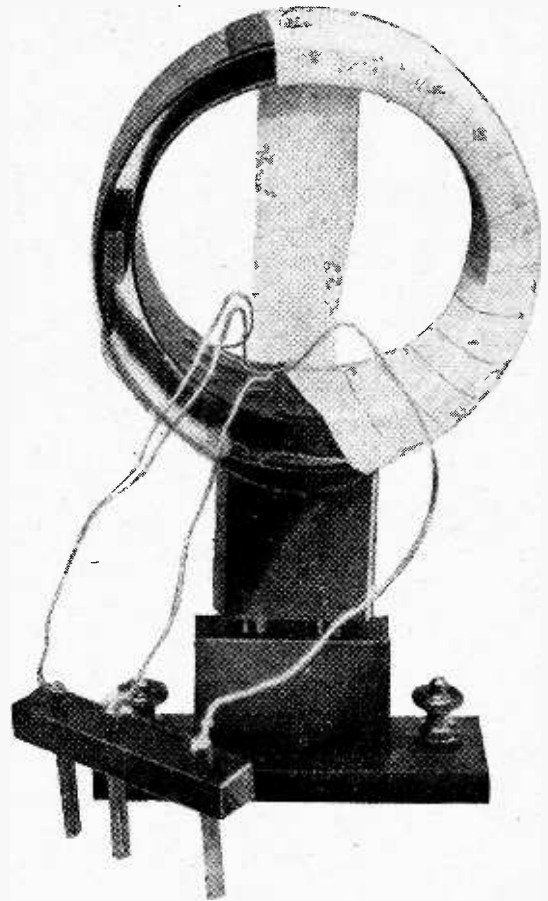

Fig. 4.—Complete transformer in process of assembly.

The primaries of the transformers B and C each consist of 30 turns of No. 28 S.W.G. and D.C.C. wire in a single layer on a 2½ in. "leatheroid" cylinder. A tapping is brought out at the 15th turn. The secondaries, on a 3 in. diameter tube, as before, need only be 1½ in.

H.F. Amplifier Design.—

long. The primary is slipped inside the

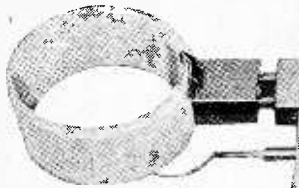
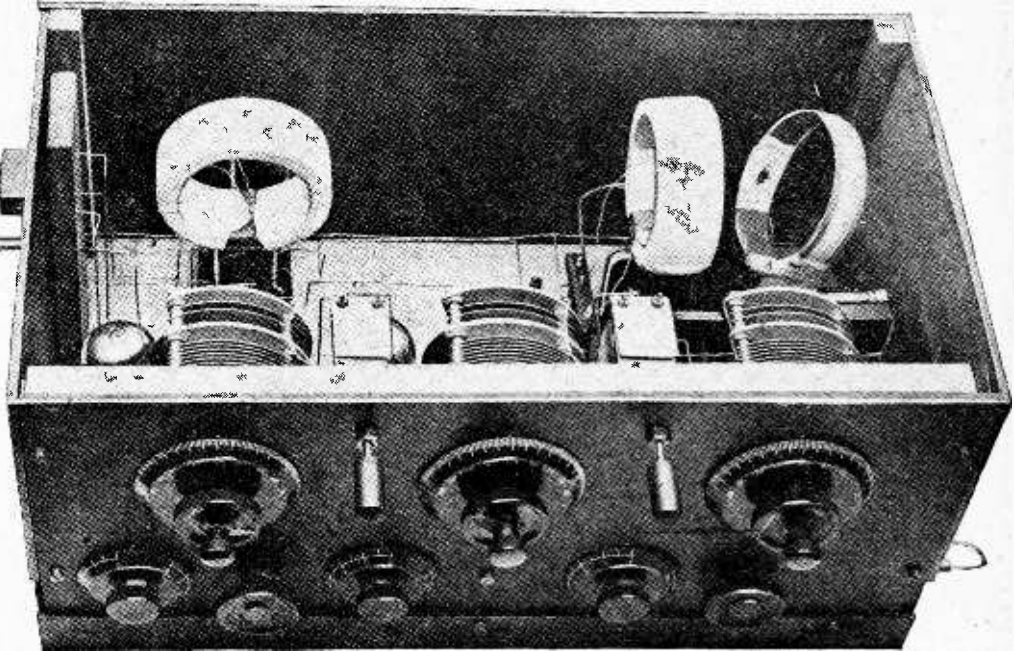

Fig. 5.—General view of the amplifier, showing relative position of the coupling transformers and tuning coils.



secondary in each case, and the three connections soldered to valve pins. The secondary is, of course, connected to the pin and socket of an ordinary coil plug, as with coil A.

Obtaining the neutralising balance is most easily carried out by tuning to the local station, turning out one or other of the H.F. valve filaments and adjusting the corresponding neutralising condenser for minimum sound in the telephones. Using this method, some indication may be gathered, even if exact balance is impossible, as to whether a larger or a smaller condenser would be more satisfactory. In the writer's opinion it is more difficult to judge this by the oscillation method, apart from the risk of annoying the neighbours. It will be found that satisfactory balance by means of the neutralising condenser can be obtained with the primary one way round only. If, therefore, trouble is experienced in this operation, the primary should be inserted in the reverse direction before a smaller or a larger neutralising condenser is tried.

On the writer's own set it is only necessary to employ the capacity balance on the shorter wavelengths (about 300 metres downwards). Above this the stray couplings are insufficient to produce oscillation, at least with the types of valves so far tried.

It will be seen from the photograph that provision is made for magnetic reaction to the grid coil of the detector valve. This is with a view to removing the damping due to cumulative grid rectification, when such is employed.

The photographs, Figs. 2, 3, and 4, show the general construction of the H.F. transformers and the method of plugging-in on the baseboard of the set. By mounting the three primary windings on valve-pins held by a strip of ebonite and arranging valve sockets in corresponding positions on the baseboard, it is possible quickly and efficiently to switch out of circuit one or both of the H.F. valves. These transformers cover a range of approximately 250 to 550 metres, with 0.0003 mfd. tuning condensers. Higher wavelength coils are constructed on similar lines. The primaries are kept to a single layer, where necessary, by reducing the gauge of wire used. The secondaries are wound in two or three layers, separated by strips of fine corrugated card, and the windings are protected with a binding of empire tape.

General Notes.

The Belgian amateur K2 working on 5 metres is anxious to work with English amateurs on this wavelength. Correspondence *via* Réseau Belge, 11, Rue du Congrès, Brussels.

Mr. F. A. Mayer (2LZ), of Wickford, Essex, was in telephonic communication with Mosul on Sunday, September 6th, working on 45 metres.

Señr. Pozzi Silvio (E1AS), Corso Torino 1, Novara, Italy, is transmitting every evening on 23 metres at about 11 p.m., and listening on 20-30 metres. He will be glad of reports from British amateurs and would like to get into communication with British transmitters on these wavelengths.

It is understood that all licensed receiving stations in Germany are given

**TRANSMITTER NOTES
AND QUERIES.**

the distinguishing numbers DE0CC1, DE0002, etc.

Mr. M. H. Wilkinson (2YW), Southerlea, Batter Lane, Rawdon, near Leeds, will welcome reports and would be glad to arrange tests with other amateurs.

Mr. P. Brian (6GW), 79, Lakey Lane, Hall Green, Birmingham, transmits almost daily on 23 metres and will welcome reports.

Mr. R. Pirotte (B4RS), of Verviers, Belgium, states that he worked with New Zealand 2AE on August 30th at 5 a.m. on 41 metres, with an input of 45 watts unrectified alternating current.

Mr. A. Acland (2UD), Kenwell, Boxley Road, Chatham, is transmitting by means of an underground aerial, and will welcome reports.

QRA's Identified.

Thanks to the courtesy of several of our readers, we are now able to give the QRA's of the following stations:—

MIDH.—Sergt. Hall, No. 6 Sqdn., R.A.F., Mosul, Iraq. (This station used to operate with call sign GHH.)

KY5, Oberdeutsche Funkverband, Stuttgart, operated by F. Sabrowsky, Gutenbergstr. 62, Stuttgart.



Brain Waves of the Wireless Engineer.

Preventing Interference.
(No. 233,416.)

Readers who live in thickly populated districts in which there is a considerable number of electrical power cables, frequently experience interference from these sources. The interference is of a low-frequency nature, and arises chiefly by ordinary induction effects, and possibly, to a certain extent, by earth current leakage. A system of overcoming this difficulty is described in the above British Patent by T. G. Threlkeld and A. W. W. Butterfield. The idea consists in screening

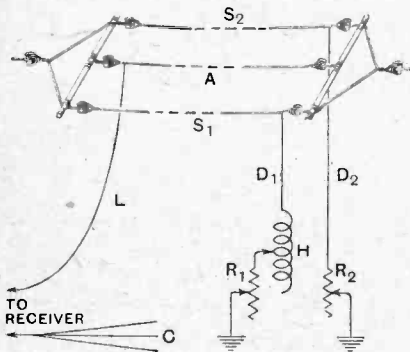

Three-wire aerial system for reducing interference from low-frequency sources. (No. 233,416.)

an ordinary receiving aerial A, having a down lead L, by two wires S₁ and S₂, arranged parallel with the aerial. The two screening wires S₁ and S₂ are provided with down leads D₁ and D₂. These are connected to earth through a damping system. The down-lead D₁ is connected through a variable inductance H, and resistance R₁, while the other down-lead D₂ is connected to earth through a variable resistance R₂. The ordinary earth is not used with the receiver, a counterpoise or earth mat C being substituted. It will be seen that the screening wires S₂ form an easy path to earth for low frequency currents, and the damping system R₂, H, R₁ tends to make them practically aperiodic in so far as radio-frequency currents are concerned, thereby lessening their effect upon the radio-frequency currents in the ordinary aerial A. We should imagine that the device would be quite successful, but might result in some rather peculiar receiving effects so far as the radio-frequency side of the question is concerned. This would largely depend upon the constants of the screening wire circuits.

A Geared Coil Device.
(No. 233,213.)

British Patent No. 233,213, granted to H. F. Bowers and E. V. Bowers, describes a form of tuning coil control which is illustrated in the accompanying diagram. One coil is fixed to an insulating support attached to the front panel of the receiver, but has been omitted from the diagram for the sake of clearness, while the other strip M is attached to an insulating shaft X, which is held in a bracket B. A knob and dial, fixed to the front of the panel, are provided at the back with a pinion G, which engages with a rack R. The rack is provided with a slot Z and works on a pin O. The rack R is connected with the shaft by means of a crank arm C. A helical return spring is provided to prevent any "back-lash" in the movement. Thus it will be seen that on rotating the knob the pinion will cause the rack to move on the pin O, and the motion imparted to the shaft X

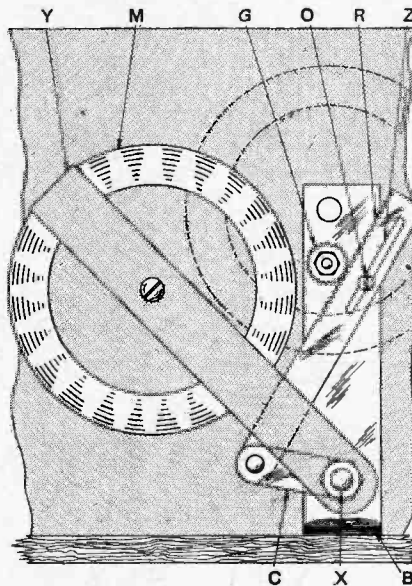

Coil holder with rack and pinion movement. (No. 233,213.)

through the crank arm will cause the coil to vary its position with relation to the coil F. The device may be used, of course, simply for varying the coupling between two inductances, or the inductances may be connected in series or parallel, and arranged as a variometer.

Neutralising the Effect of Distortion.
(No. 233,417.)

A very ingenious scheme for neutralising the effect of distortion, which has been devised by P. W. Willans is disclosed in the above British Patent, the scheme being diagrammatically indicated by the accompanying illustration. It is well known that if reaction is used in receiving telephony the sharpness of the tuning causes unequal amplification over the range of the side-tones, and inevitably results in distortion, since there is a greater reduction in the amplitude of the higher side-tones than in those of the

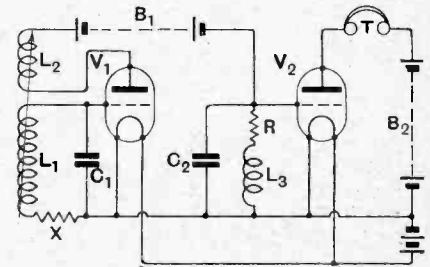

An ingenious method of correcting distortion due to reaction. (No. 233,417.)

lower side-tones. The idea of the invention consists in increasing the amplitude of the higher side-tones in the audio-frequency stages, the amplitudes of which have been decreased in the radio-frequency stages more than those of the lower side-tones, which are comparatively unaffected by the use of reaction. Referring to the accompanying illustration it will be seen that valve V₁ represents an ordinary regenerative circuit, the anode circuit L₂ reacting into a tuned grid circuit L₁, C₁, the total resistance of which is represented diagrammatically as X. A circuit consisting of an inductance L₃, a resistance R and a capacity C₂ is connected in the anode circuit of this valve, and is also connected across the input of the valve V₂. The capacity C₂ is merely a by-pass condenser, offering a high impedance to the low-frequency currents, compared with the impedance of R and L₃. The required correction is obtained by making the ratio of the resistance R to the inductance L₃ half that of the effective resistance of the circuit L₂, C₁ to L₁. It is stated that the value of the resistance R may be of the order of 3,000 ohms, and the value of the inductance L₃ may be about 0.2 henries for use in conjunction with a regenerative valve having an internal impedance of about 100,000 ohms.

A New System of SHORT WAVE TRANSMISSION.

Vertical Projection of Wireless Waves.

By E. F. W. ALEXANDERSON.

SHORT-WAVE research work in the General Electric Company's laboratories in America has revealed unexpected phenomena and new laws of wave propagation which are likely to have an important bearing on radio developments of the future. Simultaneously with the work which has led to these discoveries by prac-

always been recognised that wave motion in the ether may have two planes of polarisation, but in radio we have always been working, until recently, with vertically polarised waves, and our transmission formulas take no account of the possibility of horizontally polarised radiation. The reason why horizontally polarised waves have been neglected in the past is probably the fact that the receiving instruments used at present give no indication of such waves close to the earth, and measurements in the neighbourhood of such a station would give no evidence of any radiation whatever. At distant points the signals are, however, fully as strong as the signals produced by the ordinary waves. The waves do not follow the surface of the earth like the long waves, but are launched upwards into space and travel in a curved trajectory through the upper atmosphere. When the wave returns to earth, it is vertically polarised, and can, therefore, be received by ordinary means.

Experience with horizontally polarised waves has so far been confined to short waves, but antenna systems are being erected for making similar tests at long waves. The antenna system on the site of the research labora-

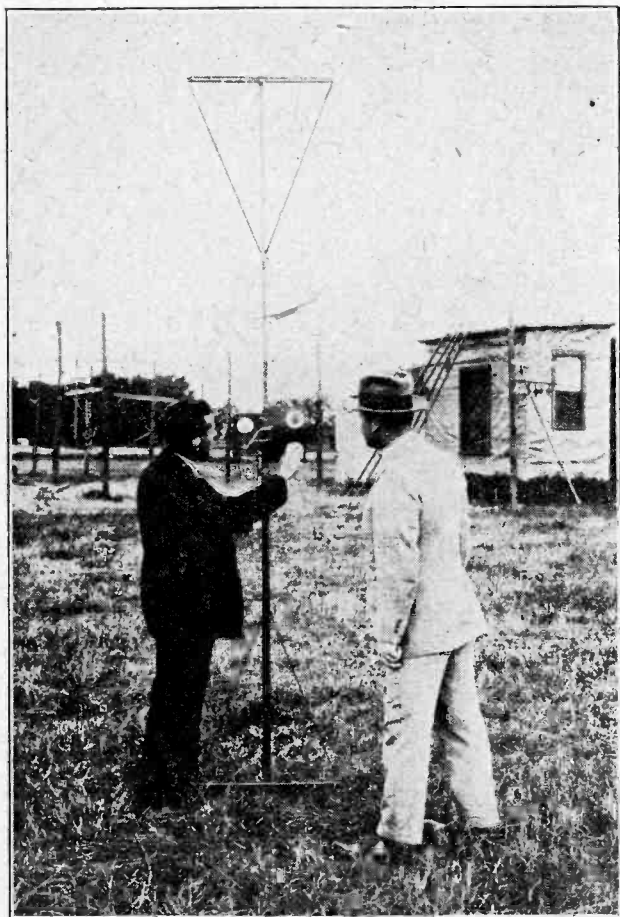

Measuring the intensity of the radiation from an aerial transmitting horizontally polarised waves.

tical research, theoretical work has been done, notably by Sir Joseph Larmor, in England, and by Dr. H. W. Nichols, of the Western Electric Company, which gives a promising explanation for the phenomena observed.

Horizontally Polarised Waves.

The tests have shown that a new form of wave propagation by horizontally polarised waves may be used to great advantage in radio communication. In optics it has

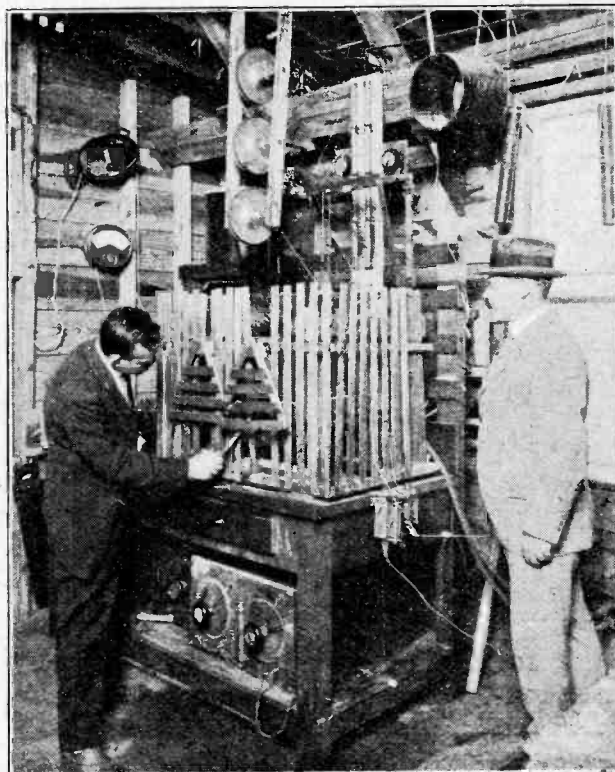

Experimental short wave transmitter used to energise the aerial.

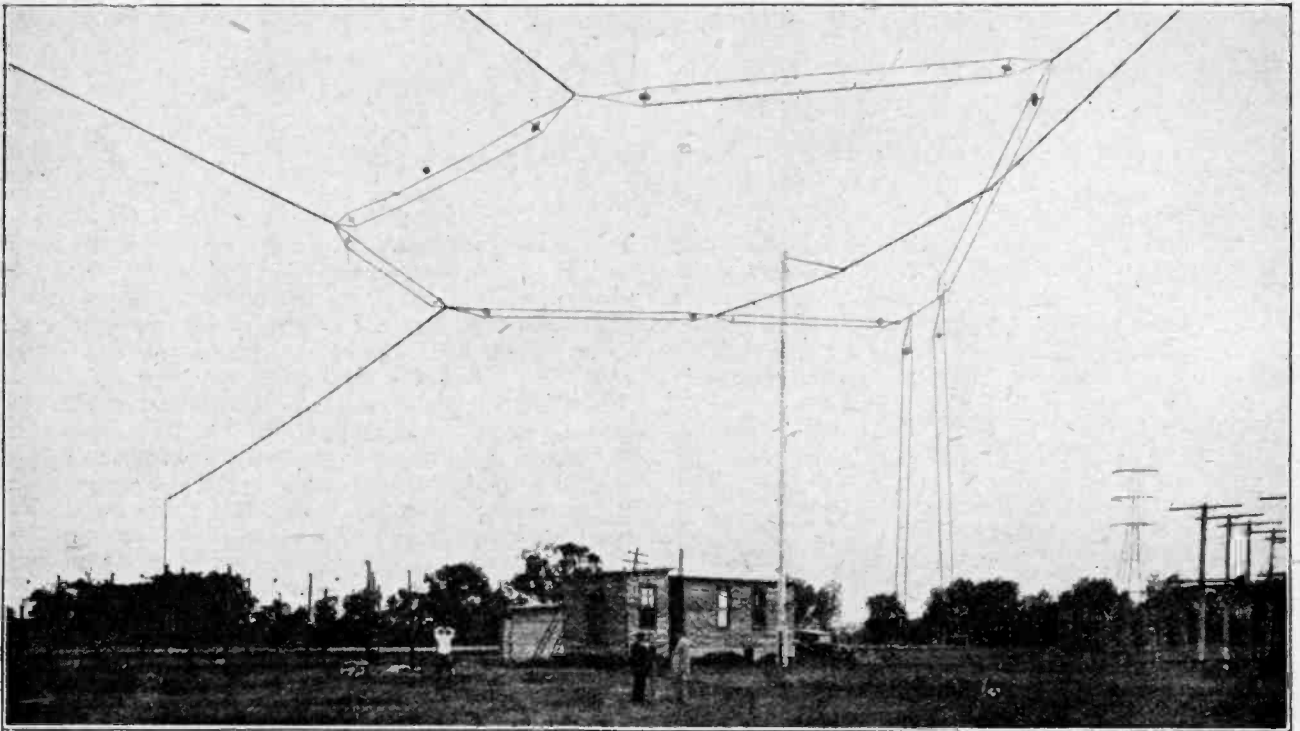

Experimental antenna system used at the G.E.C. research station, Schenectady, for the production of horizontally polarised waves.

atories of the G.E.C. of America, which has been used for the experimental transmission of horizontally polarised waves on short wavelengths, can be seen above.

Scientists are not yet able to foresee quite what relation the discovery of horizontally polarised waves will have to the problem of reduction of static, but it is probable that it will open up new possibilities for further progress. They hope to find that fading phenomena are directly due to the change in the plane of polarisation, and if methods can be found of receiving the component

of the wave which has not changed into the vertical plane, it will probably be found that static is less disturbing.

Most radio amateurs believe in the future possibilities of short-wave developments, but at the present time these new methods are not sufficiently developed, and no effective substitute exists for the high-power long-wave transmitters, such as are installed in the principal transoceanic stations of Europe and America, where commercial long-distance service is required during twenty-four hours of the day.

Cromer.

American:—1XD, 3CU, 5ATT, 5KC, 5MKT, 5PI, 5WM, 8DGM. Canadian:—4IM. French:—8AG, 8BP, 8EU, 8GW, 8NA, 8RLH. Belgian:—D2, Z2. Swiss:—9RNA, 9WWZ. Dutch:—PCMM, 5PM. Italian:—10S. Unknown:—KVT. (30-100 metres.)
(0-v-0.) ALFRED A. BARRETT
(G2BJP).

Northampton.

(August 1st to 18th, inclusive.)
British:—2ARL, 2DF, 2IN, 2NJ, 2OY, 2RG, 2VO, 2VX, 5HX, 5NJ, 5ZA, 6BD, 6DN, 6LB, 6YC, 5ZHC, 6FD, 6ZX. French:—FTJ, 3CA, 8CQ, 8EAA, 8ED, 8FQ, 8GW, 8HLL, 8HU, 8NA, 8QQ, 8SSI, 8TOK, 8UOU, 8WAG, 8XAZK, 8XG, 8YAG. Belgian:—E2, G6, H6, P7, R2, Z9, 4RE. Dutch:—OAS, OBN, OPM, ORM, 2PZ, PCMM, PCUU. Swedish:—SMLZ, SMTN, SMUK, SMUV, SMXU, SMYU, SMYZ. New Zealand:—1AN, 2AC, 2AE, 2XA, 4AK, 4AR, 4AS. Australian:—2BC, 2IJ, 2YI, 3BD, 3EF. Miscellaneous:—CH1EG, CH2LD, WAP, WNP, NRRL,

Calls Heard.

Extracts from Readers' Logs.

IIAS, IIAU, IIAV, IIBS, EAC9, EAR1, NUMM, H9RNA, H9WWZ, KAV, POF, AGA, KJ5, KK1, OCTU, FBI, 1R7AR, CSOK1, Y7XX, MIDH, XY, LA1, KXH, RDW, RAU.

(Reinartz and 1 L.F.)

P. H. BRIGSTOCK TRASLER.

Weybridge.

(August 19th-23rd.)

British:—2OD, 2LZ, 2KF, 2NM, 2FO, 5DH, 5LF, 6MP. French:—8EE, 8CT, 8CO, 8ALG, 8PRI, 8QQ, 8JC, 8TOK. Italian:—1BS, 1RT, 1GN, 1AF, 1AY. Swedish:—SMXX, SMZS, SMXU, SMYV, SMKX. Belgian:—G6, 4RE. Spanish:—2NL. Swiss:—9BR. Danish:—7EC. Dutch:—ORM. Ameri-

can:—1EP, 1AW, 1UW, 1RBA, 2ACN, 2CVU, 3OT, 3EN, 3FRE, 4ASZ, 4RL, 9CH, 9TC, WIZ, WAP, WNP, NUMM. New Zealand:—2AC, 2AE, 2AF, 2CA, 4AS, 4AK, 4AR. Australian:—2BC, 2YI, 3BD, 5BG. Chilean:—2LD. Brazilian:—1AF. Argentine:—CB8. Sundry:—BER, PS, L8JB, AIN, JKN, SGC.
P. H. DORTE
(G6DO).
(30-45 metres.)

Reading.

(July 31st to August 11th on 20-80 metres.)

British:—2KZ, 2VX, 5MA, 5WQ, 6FQ, 6UT. French:—8AG, 8ALG, 8ALL, 8CS, 8EC, 8EF, 8FQ, 8GRA, 8HGV, 8HU, 8KL, 8MN, 8MY, 8OK, 8OQ, 8QQ, 8TK, 8TOK, 8SM, 8WAQ, 8ZZ, Y2. Belgian:—BF8, 4TU, X2, B2, B4, 4VA. U.S.A.:—2NG, 4EET, 2BEE, 1VW, 9DEN, 1AHG. Dutch:—OLA, OZA, OXW, OBA, OOH, OHB. Italian:—10H, 1RT, 1FZ. Argentine:—BA1. Chile:—1EG. Swiss:—9HO. Danish:—7AR. Japan:—J2II.
(0-v-1, Reinartz.) R. C. BRADLEY.

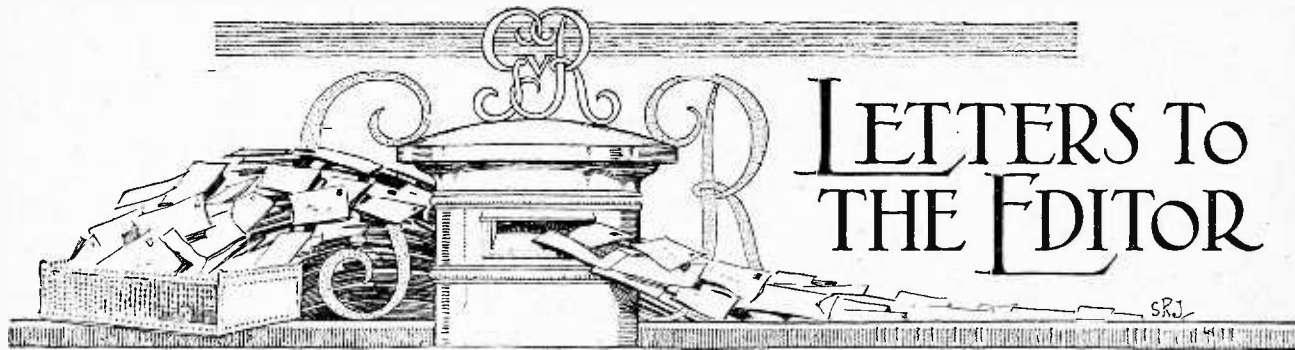

The Editor does not hold himself responsible for the opinions of his correspondents.

Correspondence should be addressed to the Editor, "The Wireless World," 139-140, Fleet Street, E.C.4, and must be accompanied by the writer's name and address.

ESPERANTO LESSONS FROM KIEV.

Sir,—I see in the correspondence pages of *Wireless World* for August 12th the statement that the radio station of Kiev broadcasts in the language Ido and will answer questions sent in that language. A similar statement appeared recently in *Novosti Radio*, of Moscow. The following reply was sent by the director of the station in answer to a query made on this point:—

"To the Kiev Divisional Department of S.E.U. (Soviet Esperantist Union).

"In answer to No. 41 I inform you that the note was printed in the journal *Novosti Radio*, No. 24, by student K.P.I., Comrade Shaparenko, who was travelling to Nijni-Novgorod via Moscow for practical work. The said note was no doubt published on his own initiative without any authority or justification.

"Director of Kiev Radio Station.

"July 29th, 1925."

"KHOMENKO."

Recently the Kiev Divisional Department of S.E.U., on the invitation of the radio station, organised Esperanto courses for radio amateurs, and is now arranging the organisation of Esperanto courses in the station after the system of the Moscow station MGSPS.

ROBERT WOOD.

Upper Holloway, London, N.19.

SUPERSONIC versus NEUTRODYNE.

Sir,—The recent article by Captain H. J. Round, M.C., on "Selectivity" must have given many readers of *The Wireless World* considerable food for thought. Captain Round's admirable summary of the nature of the problem and the lines on which a solution may be sought is conspicuous among contemporary literature inasmuch as an actual quantitative statement is given of what it is desirable to achieve and how it may be achieved. The "brass tack" is sadly to seek nowadays and is proportionately the more welcome when found.

The deductions made by the author of this article in respect of the comparative merits of the supersonic and neutrodyne systems, however, provide material for a controversy on which I cannot refrain from embarking. Captain Round does not appear to do justice to the supersonic system, and while there are undoubtedly many arguments to be advanced in favour of neutrodyne receivers, and which have been fairly advanced in the article in question, it is submitted that the "super" has been altogether too sweepingly condemned.

Captain Round's criticisms of the supersonic system may be classified under the following headings:—

- (1) The supersonic receiver tunes in two frequency channels simultaneously, thereby admitting interference through the undesired channel.
- (2) It is unsafe to employ this system with an open aerial.
- (3) It receives signals from stations operating within the intermediate frequency channel.

Taking these criticisms in the above order, it must be admitted that (1) is, *prima facie*, a defect in the supersonic system. On closer analysis, however, Captain Round's objections would appear to be unfair. The requirement is that signals from a station at a range of two miles from the receiving set should be capable of being reduced to an intensity of $\frac{1}{1000}$ of those in tune, and this can invariably be achieved in practice by selecting one or other of the two settings of the heterodyne oscillator.

In describing this process as "hoping for luck," Captain Round is surely a trifle pessimistic! In this country, at any rate, nobody is unfortunate enough to be within two miles of two broadcasting stations, and even if such a state of affairs were to arise it would require a really alarming coincidence before the supersonic system proved ineffective.

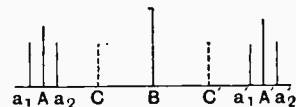

Fig. 1.

Referring to Fig. 1, let us imagine a scale of frequencies to be plotted along the straight line AA', and suppose that it is required to receive a station operating on frequency B. This can be done by setting the oscillator of the receiver either to frequency C or frequency C'.

If a strong station is operating at frequency A and the numerical difference between AC and CB falls within the audible range, interference will occur, and it will then be necessary to change the oscillator frequency to C'. If interference is caused in this case it can only be from a strong station A' such that the difference between A'C' and C'B is an audible frequency.

The conditions of fatal interference are thus that there should be two stations of strength one hundred times that of the desired station, one operating between certain limits of frequency a_1 and a_2 , and the other operating within the limits a'_1 and a'_2 . Even under these conditions we fall back upon directional methods, so it would barely seem possible that circumstances could arise which would make the supersonic system ineffective.

Referring to paragraph (2), the danger which Captain Round mentions must be admitted as a possibility in the course of tuning-in, when the aerial may for a moment be in resonance with the oscillator. Such a state of affairs is just as transitory as the oscillations generated in a set in which free reaction is used, and need not be considered any more seriously. On the other hand, it is clear that when a station is properly tuned in, the aerial is in tune with the signals it is desired to receive and the oscillator definitely out of tune by a predetermined amount. This is a safeguard which must be considered as supplementary to any balancing circuit that may be employed for keeping the oscillations out of the aerial.

If these precautions are deemed to be insufficient for absolute safety there remains the added possibility of using a loose-coupled aerial tuning system, and this, the writer submits, is an entirely satisfactory way of using an open aerial with a supersonic receiver.

The objection referred to under paragraph (3) raises a matter of very great interest. I believe that it is not generally recog-

nised that one of the most prevalent sources of intermediate frequency interference lies in the frame aerial itself when directly coupled to the set, owing to the fact that the e.m.f. directly induced in it by an intermediate frequency station is applied across the grid and filament of the valve. This is in sharp contrast to the case of an open aerial similarly connected in which the e.m.f. from such a station is induced only to a negligible extent in that part of the aerial which is included between the grid and filament. The result of this difference is that whereas in the open aerial it is only the volt-drop across the A.T.I. due to the forced oscillation which is applied to the grid and filament, in the case of the frame aerial it is the forcing voltage.

In order to make an exact comparison between the two cases let us examine the cases of an open and a frame aerial respectively, having each an inductance L , a capacity C , and negligible resistance. Suppose, further, that an e.m.f. E (sine wave) of periodicity ω be induced in the two aeriels.

The current in each case will be

$$\frac{E}{L\omega - \frac{1}{C\omega}}$$

and the volt-drop across the inductance

$$\frac{L\omega E}{L\omega - \frac{1}{C\omega}}$$

In the case of the open aerial this will be the total voltage applied to the grid of the first valve, but in the case of the frame aerial the e.m.f. E will also be added.

If V_F and V_A are the voltages in the frame and open aerial circuits respectively we have therefore

$$V_F = E - \frac{L\omega E}{L\omega - \frac{1}{C\omega}} = -\frac{\frac{1}{C\omega} E}{L\omega - \frac{1}{C\omega}}$$

$$V_A = -\frac{L\omega E}{L\omega - \frac{1}{C\omega}}$$

and this gives

$$\frac{V_A}{V_F} = LC\omega^2$$

If the circuits are tuned to a periodicity ω' we have $LC \omega'^2 = 1$, and hence the last equation may be written—

$$\frac{V_A}{V_F} = \frac{\omega^2}{\omega'^2} = \frac{f^2}{f'^2}$$

where f and f' are the corresponding frequencies.

Considering now the case of intermediate frequency interference, suppose in the above equation that f , the intermediate frequency, is 50,000 cycles per second, and f' , the frequency to which the set is tuned, is 800,000 cycles per second, then we have—

$$\frac{V_A}{V_F} = \frac{1}{256}$$

that is to say, the interfering voltage for the same e.m.f. is 256 times as strong in the frame aerial as in the open aerial.

To counteract this defect of a frame aerial I have for some time past employed a frame aerial constructed as shown in Fig. 2. Here the inductance L_1 consists of a number of turns wound on a frame of the usual type, and tuned by a variable condenser, and the inductance L_2 consists of an equal number of turns wound on the frame in the opposite sense, and untuned. The voltages induced in L_1 and L_2 respectively, by any source are equal and opposite, but whereas a current is generated in the circuit L_1C when in resonance to the induced voltage, no material current is generated in L_2 .

In the case of a signal of wavelength greatly in excess of that to which L_1C is tuned, the voltage across L_1 is substantially equal and opposite to that across L_2 , and as a result the voltage applied to the grid of the first valve is zero. On the other hand, if the wavelength of the signal corresponds to the

resonant frequency of L_1C , the voltage across L_1 will be large in comparison with that across L_2 , and the received signal will be of substantially the same strength as without the additional winding.

The effect of this arrangement in eliminating intermediate frequency interference is most surprising, and while it is obvious that signals may be picked up on the coils of the intermediate amplifier itself, interference in my own set has on many occasions been reduced from an intolerable volume to quite negligible, if even perceptible, proportions by the inclusion in circuit of the "counter-winding" L_2 .

Reverting to the main question, the objections raised to the super-sonic system do not on the whole appear to be so serious as his article would imply. The objections to high-frequency amplifiers with variable tuning on each stage, however, seem to be, if anything, more serious. In the first place, uniform performance on all wavelengths with constancy of filter band is a real desideratum, and is far more easily attained with the super-sonic system than with the neutrodyne. Secondly, there is the question of tuning adjustments.

With regard to the first there are so many possibilities in the design of this amplifier, and so many arguments which can be brought forward in favour of the long-wave constant frequency amplifier as opposed to the short wave variable frequency type that a complete discussion is outside the scope of the present note.

With regard to the second question, I would protest that I am not bigoted in the matter of multiple adjustments when it is not necessary to use all of them to tune a station in. A great feature of the super-sonic receiver in this respect seems to be that searching can be carried out with two adjusting handles, and if then it is necessary to obtain greater selectivity or to improve the performance in any respect other adjustments can be brought into play. There is no point, it is submitted, in reducing the number of adjusting handles below two, as it is perfectly easy to work one handle with each hand, but when even as few as three tuning handles have necessarily to be adjusted, and the tuning is equally dependent on all three, the matter becomes altogether more difficult and tedious.

With the neutrodyne sets as at present on the market it is necessary to know the wavelength before reception can be carried out, unless laborious searching is resorted to. On the other hand, with an instrument of the sensitivity of the super-sonic receiver we can search with the greatest ease by means of the standard two tuning adjustments, and whenever it is desired we can switch in a loose coupler in order to get the added selectivity which is provided by high-frequency tuning.

Doubtless the future will bring forth a neutrodyne receiver in which these multiple adjustments are reduced to two, or possibly even one, but this is a production proposition which requires a very great deal of exactness to achieve, and when it is considered how very easily a super-sonic set can be constructed, which has no necessity for this mechanical arrangement, it is to be doubted whether the achievement is worth while. However, in respect of the question of adjustments it is quite clear that this is less a matter of fact than of opinion, and I am only stating my personal views on the subject.

London.

P. W. WILLANS.

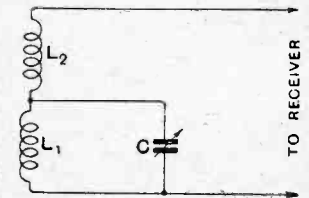

Fig. 2.

MOSUL ON ONE VALVE.

Sir,—Under the "Calls Heard" section of *The Wireless World* for August 26th I note with surprise that Mr. T. Geeson (2S0) makes a claim for record reception on one valve. I receive IDH Mosul regularly at strength R4, and I have also heard this station working G2NM in daylight.

The above reception is with a one-valve Reinartz with a short and very badly screened aerial. A. T. WILSON. Glasgow.



Readers Desiring to Consult "The Wireless World" Information Dept. should make use of the Coupon to be found in the Advertisement Pages.

Filament Supply of Two-volt Valves.

A CORRESPONDENT who is constructing a four-valve receiver in which he intends to use two-volt valves throughout, in conjunction with a two-volt accumulator, is in considerable doubt owing to the views expressed in this section of the journal in our issue of August 19th, and enquires whether, in view of our statements, it will be absolutely imperative to employ a four-volt accumulator.

It is, of course, by no means necessary to resort to the use of a four-volt accumulator, and in any case it is extremely bad practice to resort to the use of an accumulator having a voltage in excess of that normally required by any given valve according to the voltage rating stated by the manufacturers. It is probably safe to say that the average broadcast listener employs an accumulator whose ampere-hour capacity is apt to be on the small side, and, moreover, it is usually found that the accumulator is placed on the floor at a little distance from the set and connected to the L.T. terminals by a few feet of ordinary five-amp. lighting flex. Now, dealing with the accumulator first, it is necessary to employ an instrument having as large a capacity as possible, 60 or 80 actual ampere-hours being the type recommended. The accumulator being a two-volt, and not the more customary four- or six-volt unit, will not be unduly bulky—not more so, at any rate, than the average six-volt, 70 A.H. accumulator customarily used by the amateur. With regard to the usual type of "flex" used, its resistance will be found in most cases to be sufficient to stop reception through the reduction in filament current, since it is usually constructed of 14 strands of No. 36 gauge wire. It becomes necessary, therefore, to use a length of very stout flexible wire sold by electricians for use with portable electric heaters, etc., and usually known as "power flex." The resistance is very much lower, owing to the fact that 110 strands of No. 36, instead of 14 are used in its construction. Amateurs will probably remember that even in the case of two-valve sets sold complete with two-volt valves, manufacturers usually supply a length of this wire for connecting the accumulator to the set. Even then, in the case of a four-valve set, it is advisable to stand the accumulator near the set, in order to use as short a length of connecting wire as possible. In no case should filament

rheostats be included in the set, unless one can be quite sure that no resistance is left in circuit when set at maximum. The same remark applies in the case of rheostats of the carbon compression type. Our reader is therefore advised to do four things in order to avoid the use of a four-volt accumulator. Firstly, to use as large a capacity two-volt accumulator as possible; secondly, to short-circuit his filament rheostats; thirdly, to use "power flex"; and, lastly, to use as short a length of connecting wire as possible between accumulator and set.

Correct Method of Using Measuring Instruments.

IT is frequently desired by many readers to make use of various measuring instruments in the circuits of their receivers, in order to determine accurately such quantities as the value of the steady anode current in the plate circuit of a valve, or the actual voltage difference between the two ends of the filament as distinct from the accumulator voltage.

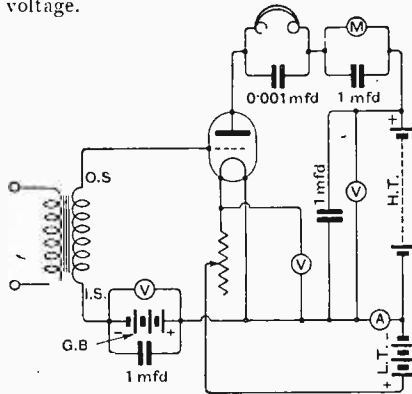

Correct positions for indicating instruments in a single-valve L.F. amplifier.

In order to obtain a clear understanding of the correct connections of the various measuring instruments, we have illustrated a typical L.F. amplifying circuit, with various measuring instruments correctly connected up in their respective positions.

Take, for instance, the filament voltmeter: it will be seen that connected as it is it will accurately indicate the voltage drop across the filament. Quite a large number of people are apt to make the

connections to the wrong side of the filament rheostat, so that the voltmeter indicates the drop across both filament and rheostat. The connections should be made quite close to the filament sockets on the valve holder, as with large filament currents the voltage drop in the wiring of the set may be considerable. It is essential to use a high resistance voltmeter when desiring to measure the voltage across the filament, otherwise a fictitious reading will be obtained. In the case of most of the cheaper grades of voltmeter upon the market, a noticeable drop in the filament brilliancy will occur immediately the voltmeter is connected up.

The ammeter associated with the filament of the valve is very useful in the case of correctly adjusting the filament temperature of dull emitter valves particularly those with oxide-coated filaments, but care should be taken to connect it so that it indicates the current of only the particular valve whose filament temperature it is desired to adjust. It is of little use to place it in one of the common L.T. leads, unless it is desired to ascertain the total current from the accumulator. The voltmeter across the grid battery is useful when desiring to ascertain accurately the steady voltage impressed on the grid in the case of adjusting an L.F. amplifier. Similarly the milliammeter in the plate circuit of the valve is a useful instrument to use in order to determine whether a power valve is operating on the correct portion of its curve. The needle of this instrument should remain steady when telephony is being received. Flickering of the needle indicates insufficient H.T., incorrect grid bias, or overloading of the valve.

The H.T. battery voltmeter can either be connected across from the common H.T.—to any particular H.T.+ tapping as required, or can be used to ascertain the total voltage of the battery; but here again the cheap voltmeter used by most retailers for testing batteries will not only give a fictitious reading but will do actual harm to the H.T. battery, owing to the heavy current taken. When connecting a voltmeter directly across the terminals of an accumulator it is necessary to see that the accumulator is actually delivering current to the valves in order to obtain a true idea of the actual charge inside the accumulator, since even if a high resistance meter is used, a false idea will be obtained of the condition of the accumulator if tested on open circuit.

Range of a "Standard" Four-valve Receiver.

A CORRESPONDENT seeks our advice upon the question of a suitable set to receive all main B.B.C. stations on the loud-speaker, using a normal aerial and earth. He states that he is at present using a "standard" four-valve set employing one stage of tuned anode H.F., detector with reaction, plus two transformer-coupled L.F. stages, but results are very discouraging, and he therefore proposes to use five valves by converting the set to two tuned anode stages.

This course of procedure is certainly not to be recommended, since in our opinion if our reader does not obtain satisfactory results on one tuned anode stage, he will do no better by adding a further stage. It is quite a fallacy, but unfortunately a very prevalent one, to suppose that it is necessary to employ a receiver having a large number of H.F. stages for the purpose mentioned by our reader. Using a reasonably efficient aerial and earth system, all main B.B.C. stations

BOOKS FOR THE WIRELESS EXPERIMENTER

Issued in conjunction with "The Wireless World."

"THE AMATEUR'S BOOK OF WIRELESS CIRCUITS," by F. H. HAYNES. Price 3/6 net. By Post, 4/-.

"TUNING COILS AND METHODS OF TUNING," by W. JAMES. Price 2/6 net. By Post, 2/10.

"WIRELESS VALVE RECEIVERS AND CIRCUITS IN PRINCIPLE AND PRACTICE," by R. D. BANGAY AND N. ASHBRIDGE, B.Sc. Price 2/6 net. By Post, 2/10.

"WIRELESS VALVE TRANSMITTERS—THE DESIGN AND OPERATION OF SMALL POWER APPARATUS," by W. JAMES. Price 9/- net. By Post, 9/6.

"DIRECTION AND POSITION FINDING IN WIRELESS," by R. KEEN, B.Eng. Price 9/- net. By Post, 9/6.

"THE RADIO EXPERIMENTER'S HANDBOOK," Parts 1 & 2, by P. R. COURSEY, B.Sc. Price 3/6 net. By Post, 3/10.

Obtainable by post (remittance with order) from
ILIFFE & SONS LIMITED,
Dorset House, Tudor St., London, E.C.4.,
or of Booksellers and Bookstalls

elusive station will bring in also a medley of discordant sounds due to atmospherics and such-like annoyances.

We are of opinion, therefore, that either our reader's set is not very efficiently constructed, or that his aerial and earth system require to be improved. The difference between a poorly laid out receiver and a technically well laid out receiver employing the same circuit and the same components is too little realised by the average set user. Similarly the enormous advantage that can be obtained by raising the aerial ten or twenty feet above its normal level is far too little emphasised in many technical publications.

o o o o

Alternative Crystal Rectifier.

A READER is desirous of building a four-valve receiver in which optional crystal rectification is obtainable, a stage of H.F. being incorporated into the receiver irrespective of whether valve or crystal rectification is to be used. It is also required that jack switching be employed to eliminate the

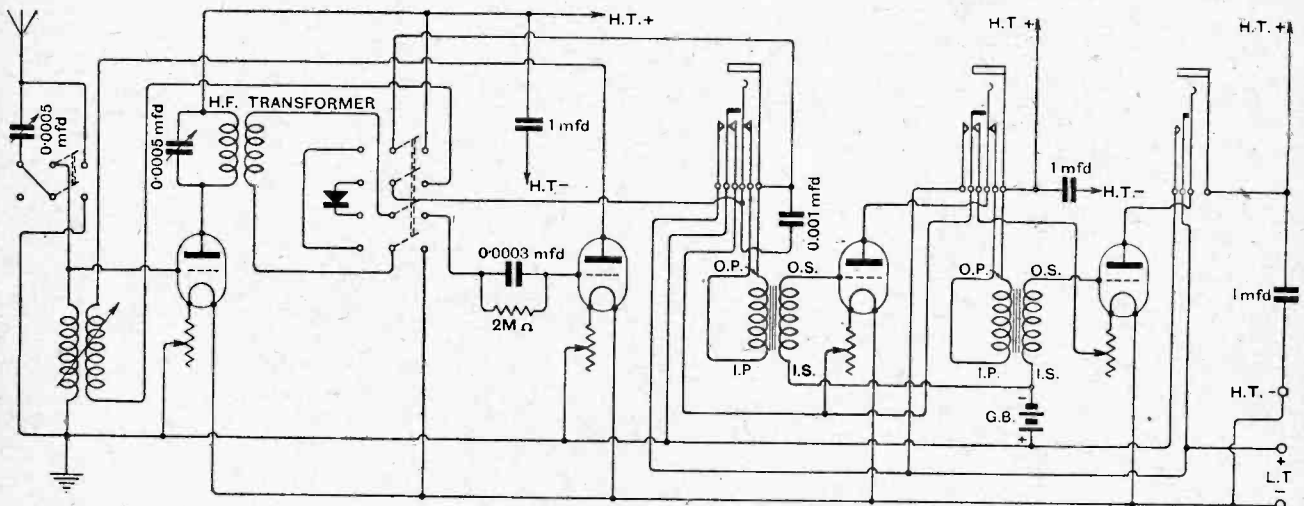

Four-valve receiver with alternative crystal rectification and jack switching for the L.F. amplifying valves.

are quite comfortably within the range of a good four-valve set. If two tuned anode stages are used, the extra sensitivity provided by the additional H.F. stage is offset by the deliberate damping that has to be introduced to effect stability, and there is no more likelihood of distant stations being received. It frequently happens that the reduction in sensitivity brought about by the damping that has to be introduced more than counteracts any additional sensitivity due to the extra H.F. stages. This is quite apart from such disadvantages as the complication of tuning due to the additional controls and the additional drain on the H.T. battery.

It can safely be said that if any given station is genuinely outside the range of a good four-valve set, operated on a reasonable aerial and earth system, then it is best to abandon any attempt to receive the station, since if a more sensitive set is employed to bring it in, results

will not be entirely satisfactory from the musical point of view, since the additional sensitivity required to bring in the

L.F. valves according to the requirements of volume.

A suitable circuit is shown in our diagram above. It will be noticed that a four-pole switch is used to effect the change over from crystal to valve rectification. A further point to notice is the method of jack switching employed. This is so arranged that upon withdrawing the telephone plug all valves, including the H.F. and detector, are automatically extinguished, all batteries being then disconnected. Upon inserting the telephone plug into the jack following the detector valve, only those valves which are required are brought into circuit, the filament circuits of the L.F. valves remaining broken. If the telephone plug is inserted after the final valve, all the previous valves light up.

A plain aerial tuning circuit has been adopted which is tuned with a 0.0005 mfd. condenser in series or parallel with the A.T.1.

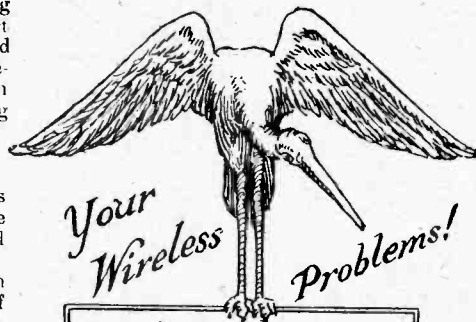

Don't have a long bill — write to us

The Wireless World

AND RADIO REVIEW

No. 319.

WEDNESDAY, SEPTEMBER 23RD, 1925.

VOL. XVII. No. 13.

Assistant Editor:
F. H. HAYNES.

Editor:
HUGH S. POCOCK.

Assistant Editor:
W. JAMES.

Editorial Offices: 139-40, FLEET STREET, LONDON, E.C.4

Telephone: City 4011 (3 lines).

Advertising and Publishing Offices: DORSET HOUSE, TUDOR STREET, LONDON, E.C.4

Telephone: City 2847 (13 lines).

Telegrams: "Ethaworld, Fleet, London."

COVENTRY: Hertford Street.

BIRMINGHAM: Guildhall Buildings, Navigation Street.

MANCHESTER: 199, Deansgate.

Telegrams: "Cyclist Coventry."
Telephone: 10 Coventry.

Telegrams: "Autopress, Birmingham."
Telephone: 2970 and 2971 Midland.

Telegrams: "Hiffe, Manchester."
Telephone: 8970 and 8971 City.

Subscription Rates: Home, £1 1s. 8d.; Canada, £1 1s. 8d.; other countries abroad, £1 3s. 10d. per annum.

As many of the circuits and apparatus described in these pages are covered by patents, readers are advised, before making use of them, to satisfy themselves that they would not be infringing patents.

THE ETHER PROBLEM IN EUROPE.

THE establishment of the Geneva International Broadcasting Bureau took effect only just in time to provide a temporary remedy for a situation which was rapidly tending towards getting out of hand altogether. But, although the Bureau has already done good work and has paved the way for future useful activities, we believe that we are yet far from arriving at a solution of the present difficulties and are certainly not in a position to foresee a remedy for the complications which must necessarily arise as the number of broadcasting stations in Europe increases.

Our Earlier Criticisms.

Early this year, before the establishment of the Geneva Bureau had been contemplated, we commented on the position as it then stood, and criticised the policy of the B.B.C. in encouraging the increase of power of their stations so that they should bring crystal sets all over the country within range. Our attitude was opposed in a letter from Captain Eckersley, published in our issue of April 1st of this year, when an attempt was made to justify the B.B.C. policy on the grounds that the B.B.C. must first cater for the requirements of the less wealthy sections of the public who could, it was argued, only afford the cheaper crystal sets. We appreciate the ideals which have prompted the adoption of this attitude, but, nevertheless, we regard it as a short-sighted policy which ignores the effect which it must have upon the future development and utility of the broadcast service.

Wavelength Changes.

It would be idle to suggest that the re-allocation of wavelengths throughout Europe has been effected without very considerable difficulty, and, further, it is doubtful whether, having effected these changes, there has been brought about that freedom from interference between one station and another which it was hoped to achieve. The opinions of many observers in different parts of Europe is that certain stations are still badly heterodyned by others, and if this is the state of affairs to-day when comparatively few European stations are in operation as compared with those which are projected, one must naturally feel anxiety as to what the future position will be. The B.B.C. have implied that they have little faith in any lasting interest amongst the public in the reception of any but the local station; but if that is the case, how is it that the tendency in the design of wireless receivers should be towards increased selectivity and efficiency for distant reception?

Contradiction of Policy.

Then, again, we have evidence of what would appear to be a contradiction of policy on the part of the B.B.C. in the publication of a weekly periodical devoted to the inclusion of the foreign programmes, and still further evidence in the receiving station set up at Hayes, where the B.B.C. is satisfied that they can receive foreign programmes sufficiently well to re-broadcast them in this country, and this in spite of the fact that only a few months ago the Chief Engineer, in a broadcast technical talk, reviewed the position of reception of distant

CONTENTS.

	PAGE
EDITORIAL VIEWS	379
PUSH-PULL RECEIVER-AMPLIFIER	381
By N. P. Vincer-Minter.	
NOVELTIES FROM OUR READERS	387
THE SHORT WAVE	389
By A. H. Morse.	
CURRENT TOPICS	393
THE RESISTANCE-COUPLED AMPLIFIER	395
By Dr. H. Kröncke.	
BROADCAST BREVITIES	399
THREE-VALVE REINARTZ RECEIVER	401
By A. R. Turpin.	
VALVES WE HAVE TESTED	406
CRYSTAL DETECTORS (continued)	407
By F. M. Colebrook.	
NEW APPARATUS	410
RECENT INVENTIONS	411
LETTERS TO THE EDITOR	412
READERS' PROBLEMS	413

stations and conveyed the impression to his listeners that it was practically useless to attempt distant reception if anything like intelligible quality was to be expected.

What may be Expected.

Time will show what will be the ultimate extent of popular interest in receiving distant stations, but we believe that one of the principal fascinations in wireless, apart from the purely utilitarian aspect, will be the ability in the future to turn from one station to another, passing from one European capital to another and achieving these results without difficulty and without serious interference except for extreme cases of atmospheric trouble, for which, at the present time, no remedy is forthcoming. If this is to be made possible for the

Some months ago we suggested that, as the number of stations increased, so the time would arrive when the band of wavelengths at present allotted for broadcasting (leaving out of consideration, of course, the higher wavelengths) would prove inadequate to accommodate all stations, and that it would be necessary to resort to utilising wavelengths of a lower order where the frequency spacing would assist in accommodating a very large number of additional stations. So far, the Geneva Bureau has not concerned itself with broadcast wavelengths below 200 metres, and, in fact, for the moment, no changes are being made in wavelengths just above this band. In the near future it seems certain that permission will have to be obtained for stations to operate on these lower wavelengths, but here we have a task which can only be undertaken after very careful investigation.

Short Waves for New Stations.

There are still several countries in Europe where broadcasting has not developed to any considerable extent, and where certainly the manufacture of broadcast apparatus as an industry has scarcely been entered upon. In our opinion it is to these countries that the shorter wavelengths should first be allotted, because this will bring about the least dislocation of any existing organisation or industry. It will not easily be forgotten how the introduction of a long-wave broadcasting station in this country upset the calculations of the designers of apparatus and produced a temporary set-back in the development of designs for receivers, even though it must be admitted that at the

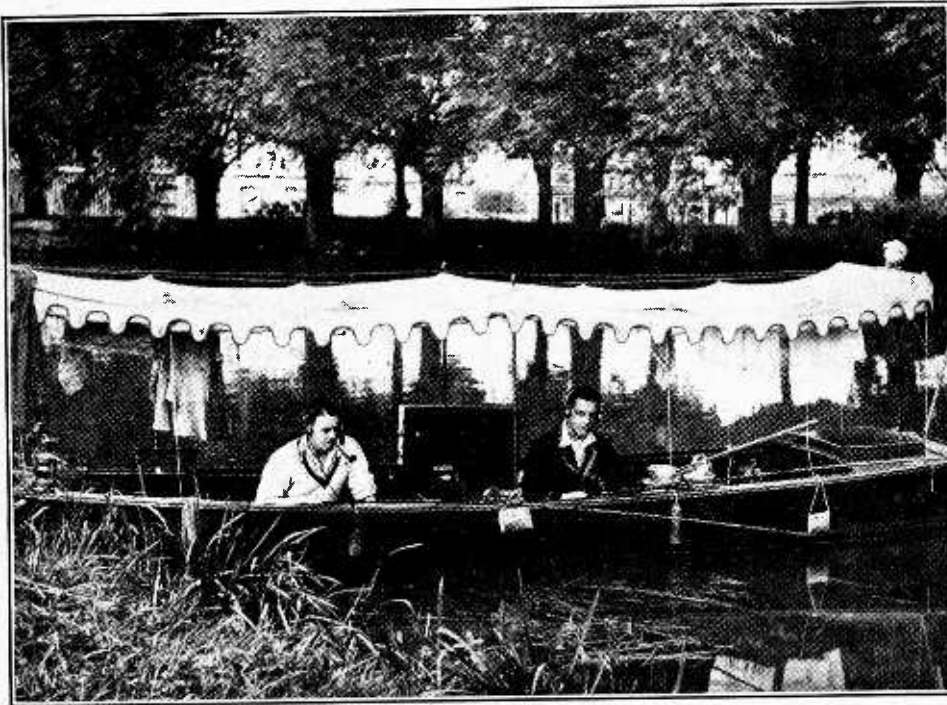

There are times when infinite patience can be more easily maintained with the aid of broadcasting.

future, it cannot be done by increasing the power of broadcasting stations; instead—as we have repeatedly suggested—the ideal must be to operate the broadcasting stations with the minimum power and to cheapen receiving sets and increase their efficiency to the utmost possible extent.

Crystal sets must eventually be superseded by a more efficient method of reception, and, as manufacturing costs fall, so valve receivers will be available at a price which must put them within the reach of anyone who to-day is able to acquire a crystal set.

The Remedy of Short Waves.

A reduction in the initial power of broadcasting stations cannot alone effect a solution of the difficulties arising through the increase in the number of broadcasting stations in Europe, but there is a further direction in which an attempt can be made towards solving the problem.

same time it stimulated the sale of certain types of receivers, particularly crystal sets where tuning arrangements were not complicated to any great extent by having to cater for two extremes in wavelength range. Those countries where broadcasting has become an established industry should, in our opinion, be very slow to introduce new wavelength bands which are not taken into account in the receivers at present on the market or supplied to the tens of thousands of listeners in this country.

We realise, of course, that progress must not be hampered, and it is equally certain that no artificial regulations, however carefully conceived, can hold up changes which might affect commercial interests adversely, but at the same time we feel that, as a solution of the problem of ether congestion, the allocation of short waves should certainly be first made to those countries where the least dislocation of an existing industry and organisation would be felt.

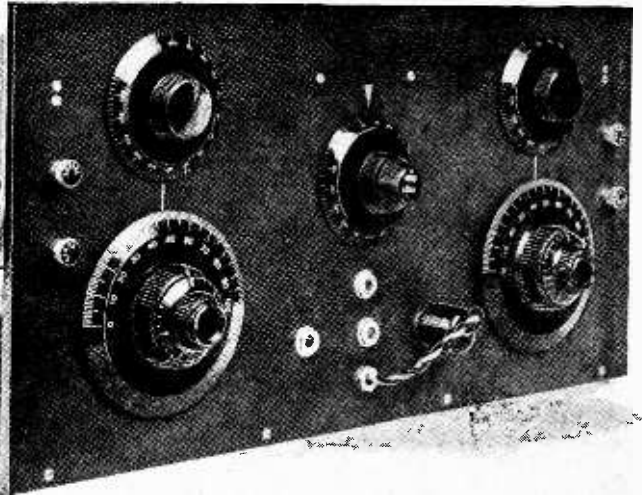
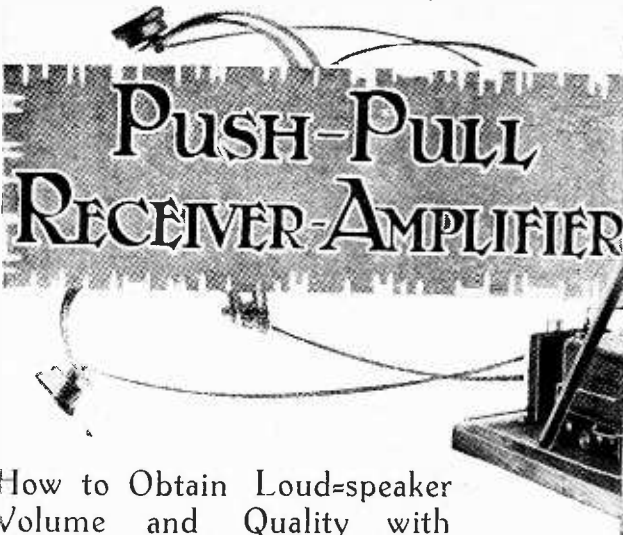

How to Obtain Loud-speaker Volume and Quality with General Purpose Valves.

By N. P. VINCER-MINTER.

IN considering the question of designing an amplifier to give high-quality amplification of speech and music, it is first necessary to carefully analyse the chief contributory causes to the distortion which all too frequently is delivered by the average loud-speaker through no fault of its own. Since it is intended that this article shall mainly concern itself with the distortion arising in the L.F. amplifier, no attempt will be made to deal with the distortion originating within the receiver itself due to the misuse of reaction, the employment of unsuitable values of grid leak, etc. The distortion arising in a low-frequency amplifier may be broadly divided into two classes, under the headings of frequency distortion and amplitude distortion. Frequency distortion arises in the interval coupling

whilst the valve itself is the chief cause of amplitude distortion.

Distortion in L.F. Amplifiers.

Dealing first with frequency distortion, we may define it as the uneven amplification of the various musical frequencies, this taking the form of a decline in actual amplification towards either extremity of the musical scale, the decline being usually much more rapid at the lower end of the scale, where often the curve of amplification plotted against frequency takes quite a sharp downward sweep somewhere between the frequencies of 400 and 1,000. In addition to this, certain resonant peaks sometimes appear in the horizontal portion of the curve, resulting in very greatly increased amplification of certain musical frequencies, to which the intermediate coupling resonates, due chiefly to inferior design. In order to overcome this form of distortion, it is necessary, as the writer has previously pointed out in this journal,¹ to insert an extremely high impedance in the anode circuit of the detector or subsequent L.F. valve, so that the voltage set up across the impedance by the various musical frequencies are all more or less equal—that is to say, in order to obtain perfectly distortionless frequency amplification, it is necessary that the voltage set up by the lowest musical frequency be neither greater nor less than that set up by the highest or any intervening musical frequency. This is an ideal not yet realised by even the

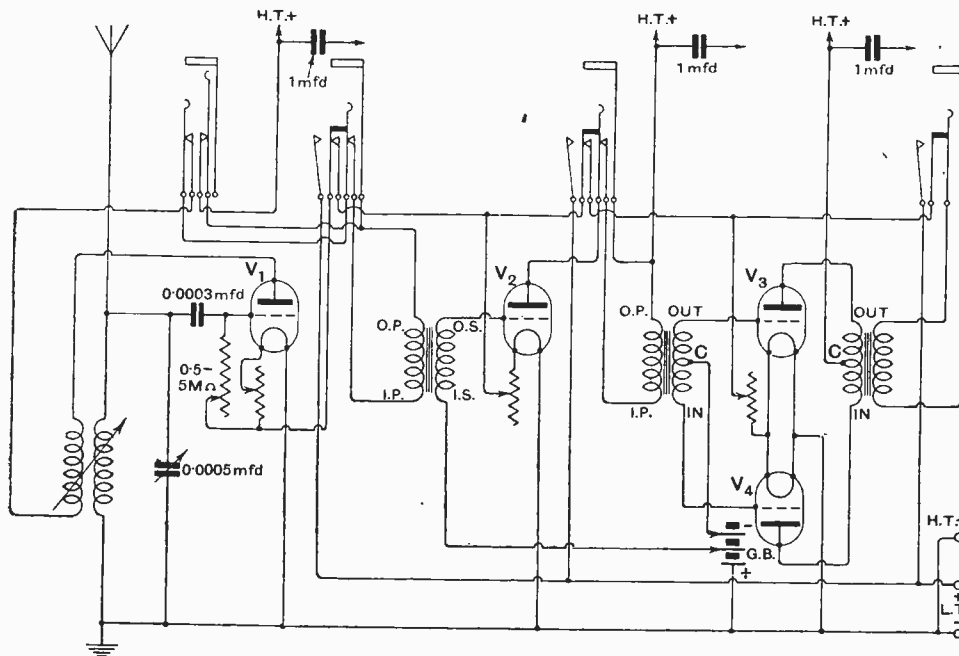

Fig. 1.—Circuit diagram, showing connections of auxiliary input and telephone jacks.

¹ *The Wireless World*, April 1st, 1925, p. 247.

Push-Pull Receiver-Amplifier.

best of amplifiers, nor, indeed, in the transmitting instruments themselves, but, provided that we make this impedance two or three times greater than the internal impedance of the valve in whose anode current it is connected, we shall obtain a very fair approximation to the ideal. Even were it possible to produce a perfect coupling as suggested, we are at present limited by the design of the headphones and loud-speakers, which still need considerable research work upon them before they can do justice to a really well-designed receiver and amplifier. There

are three types of intervalve coupling which it is possible to use in an L.F. amplifier—transformer, choke, and resistance coupling. Let us first consider briefly the advantages and disadvantages of the three forms of coupling we have mentioned. Transformer coupling possesses the great advantage that it is possible to obtain a voltage step-up in the transformer itself apart from that obtainable in the valve, but unless good transformers are employed, there is apt to be a marked falling off in the amplification at the lower end of the musical scale. Choke coupling has the advantage that, even with chokes of quite medium price, it is usually possible to obtain more even amplification than with transformers of similar quality, but it is usually not possible to obtain a greater amplification than 90 per cent. of the amplification factor of the valve, thereby losing the great advantage of transformer coupling, namely, valve economy. A resistance-coupled amplifier is productive, when properly arranged, of even greater fidelity of amplification than choke coupling, but possesses the very serious drawback of requiring

a high value of H.T. and of giving an even less percentage amplification per stage than choke coupling. Three years ago, at the very inception of broadcasting, resistance coupling was actually a *sine qua non* for musically inclined people, since all the transformers that were then upon the market were actually designed to have a marked resonance peak somewhere round about 1,000 cycles per second for the purpose of radiotelegraphic work. Nowadays, however, when a large number of really excellent transformers are available, the discrepancy between the results obtainable from a resistance-coupled amplifier and a really good transformer amplifier is very small. The writer, who has had the opportunity of hearing all types of amplifier, has yet to hear the resistance-coupled amplifier having a sufficient margin of superiority over a good transformer-coupled amplifier to cause him to contribute excessively towards the support of H.T. battery manufacturers. A good transformer amplifier is very markedly superior to a mediocre resistance-coupled amplifier in which no attention has been paid to

other important details, such as the coupling condenser.

Amplitude Distortion.

Having dealt with frequency distortion, we can pass on to the question of amplitude distortion which arises in the valve. As is well known in the case of a valve amplifier, the varying voltage changes impressed on the grid of the valve by the signals passed on from the preceding valve coupling causes a correspondingly proportionate rise or fall in the steady current flowing in the anode circuit of the valve. In the case of the

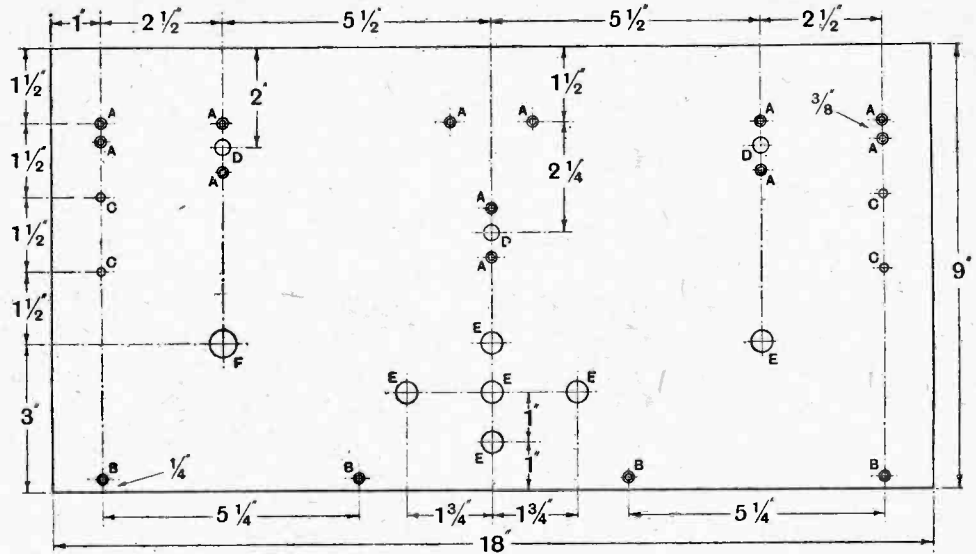

Fig. 2.—Drilling details of front panel. The diameters of holes are as follow: A, 1/8in. dia., countersunk for No. 6 B.A. screws; B, 1/8in. dia., countersunk for No. 4 wood screws; C, 5/32in. dia.; D, 5/16in. dia.; E, 7/16in. dia.; F, 9/16in. dia.

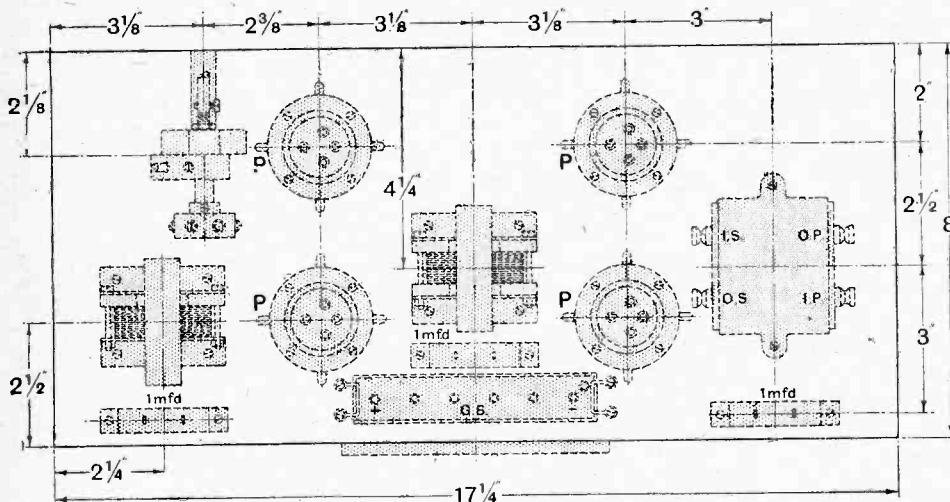

Fig. 3.—Layout of components on the baseboard.

Push-Pull Receiver-Amplifier.—

ordinary valve, however, if the voltage swing on the grid is too large, then the proportionate increase and decrease of the anode current no longer holds true, and the operating point of the valve is carried off the straight line portion of the grid volts-anode current curve beyond the danger limits of "bottom bend" and "zero grid volts." As this matter has been fully dealt with in previous issues of this journal, no attempt will be made to enlarge upon it. By increasing the anode voltage on an ordinary valve to about 100, and suitably adjusting grid bias, the valve can be made to handle more power without overloading, owing to the fact that an increase of H.T. voltage will up to certain limits bring about an increase in the "straight line" or "working" portion of the curve, and in this way an ordinary valve may be rendered suitable for the first stage of amplification, but not for the second. In the second stage it is necessary to use a power valve which has a very much greater working portion of curve.

The "Push-Pull" Principle.

Now, unfortunately, power valves are expensive in the first place, and those readers, on the one hand, who may not care to pay more than 8s. for a valve, and those, on the other hand, who, by reason of dwelling in the country, are forced to use dull emitters, may well ask whether there is no alternative to the use of an expensive power valve in order to overcome amplitude distortion. Fortunately, the answer is in the affirmative, although many people seem to be ignorant of this fact. We can surmount the difficulty by employing two ordinary valves in the last stage,

system have been adequately dealt with in a previous issue by a more able pen,² no attempt will be made to enter into the theoretical aspect of the circuit. Suffice it to say that as the grid of one valve becomes more negative the grid of the second valve becomes correspondingly less negative, and therefore it will be seen that as the anode current of the former decreases so the anode current of the latter increases, and so the result of the two currents flowing in the two halves of the

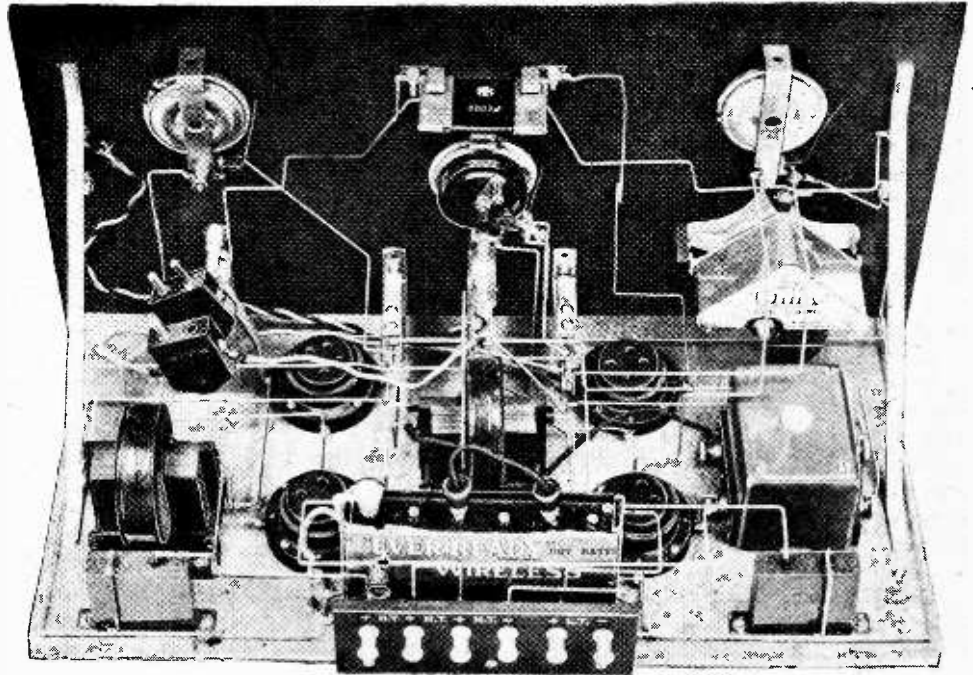

Fig. 4.—Rear view of the instrument, showing layout and wiring of the components.

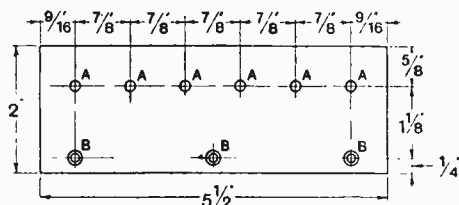

Fig. 5.—Terminal panel. A, 3/32in. dia.; B, 1/8in. dia., and coun ersunk for No. 4 wood screws.

connected up in the manner shown in Fig. 1, which is known under the name of "push-pull." It will be seen that two special transformers are used; one, the input transformer, having a centre-tapped secondary, and the other, the output transformer, having a centre-tapped primary. Now, since the full technical details of this

primary of the output transformer is to give a "see-saw" or "push-pull" effect, and the combined output of the two valves is transferred to the secondary of this transformer and so to the loud-speaker. Perhaps it will be better understood if it is said that the effect produced by the push-pull method is to add together the two working portions of the curves of the individual valves, thus giving a combined working portion equal to that of a power valve. In practice this system is productive of most excellent results, and it is unfortunate that it is not more generally used, and the purpose of the receiver herein described is to give a practical design for a receiver of this type, although of course it must be realised that the amplifier portion of this receiver can be used after a receiver of any type, and for this purpose the extra jack shown above the other three has been provided, so that by attaching a plug to the telephone terminals of any receiver and plugging-in this jack the receiver embodied in the amplifier is instantly thrown out of circuit. This is a point in receiver design which could be made much more use of than it is, since no one cares to "lock up" expensive transformers or resistance coupling units in one receiver, and it is far better to spend money on one really good set of L.F. components

² *The Wireless World*, June 4th, 1924.

Push-Pull Receiver-Amplifier.—

than to purchase two or three sets of mediocre components.

The first step in construction after having obtained the components is to attach the panel to baseboard. The panel is of standard size, and can be obtained ready "dressed" from all reputable dealers. The jacks should be wired very carefully, otherwise valve manufacturers may be benefited considerably. When wiring the jacks

there are three others which enable reception to be carried out after the detector valve, after the first L.F., or after the push-pull portion of the circuit. Filament switching is also arranged in these jacks, so that the filaments of only those valves which are required light up. Thus, by plugging in the first jack only, the detector valve lights up, but by plugging into the final jack all valves light up. Removal of the plug automatically disconnects all batteries. The system adopted of having two terminals

for attaching loud-speaker or headphones, the plug being attached by a flexible lead coming through a bush under the three jacks, is a very great convenience, since it completely destroys the argument always advanced against the use of jacks that it is necessary for every pair of headphones to be fitted with a plug.

The Amplifier.

The first stage of amplification used in this receiver is of course of the conventional type, and either resistance or choke coupling could be used here if desired. There would of course be no advantage in making both stages operate on the push-pull principle, although it can quite easily be done, since it is unlikely that the valve in the first stage of low frequency amplification will be overloaded.

Although the primary object of designing a push-pull amplifier is to employ ordinary bright or dull emitters throughout, it must not be thought that this is its only object. Since the effect of connecting two valves in this manner is to double the working portion of the curve, so that the permissible input voltage swing to the grids of the two general purpose valves is equal to that of a D.E.5 type valve, it is obvious that by using two D.E.5 valves in this manner we can obtain an approximation to the power available with a large power valve of the L.S.5 type. This is exceedingly useful, since it frequently happens that it is desired to design an amplifier which is to be used in a small hall for dancing purposes, or even for an outdoor demonstration. In this case an amplifier having two stages may not give the required volume, whilst if a further stage is added, using a D.E.5 valve in the last stage, the distortion due to overloading this valve will be quite

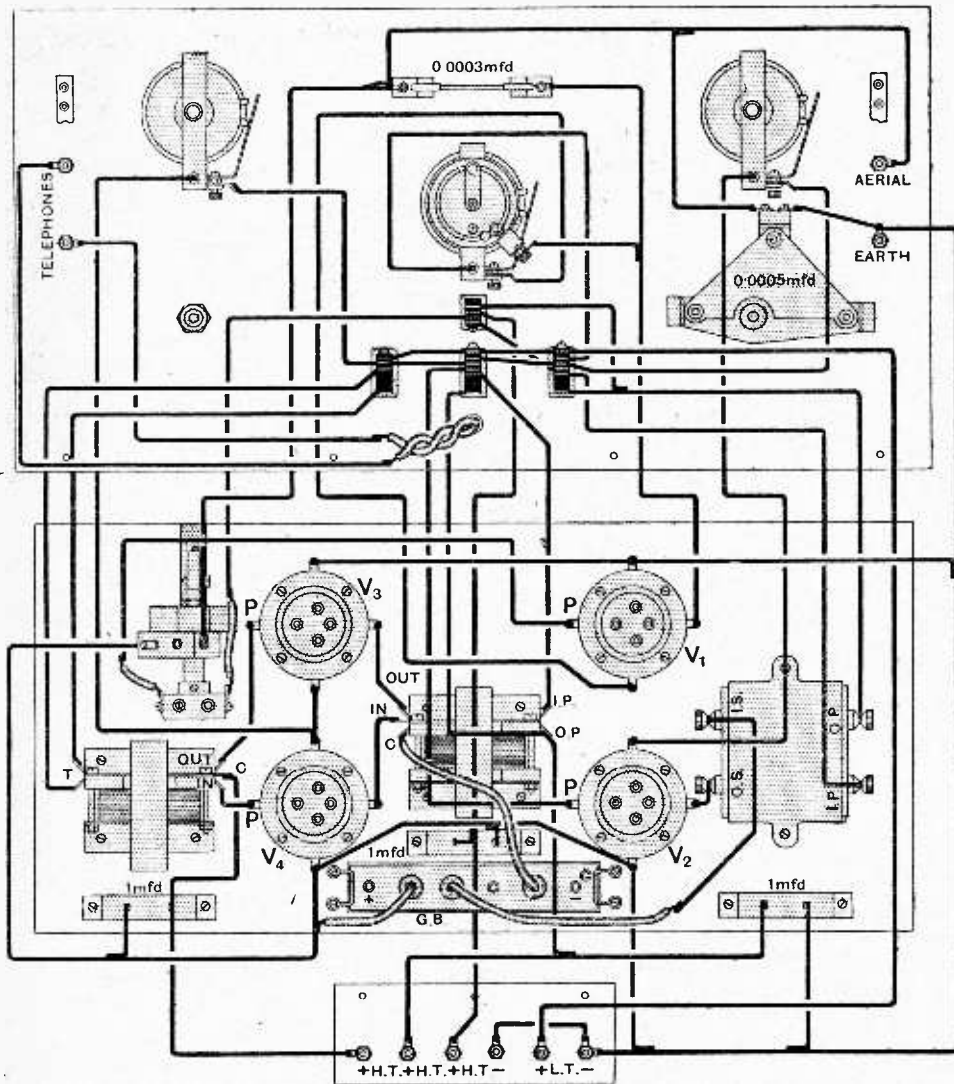

Fig. 6.—Complete wiring diagram. The push-pull transformer connections are lettered to correspond with the marking on the actual components.

it will be found that the operation of making the rather multifarious connections to them may be greatly simplified by temporarily removing the input push-pull transformer. It is as well to adhere as closely as possible to the actual lay-out used by the writer in this instrument, although if any alteration is carried out to suit individual needs it is well to see that all components are very carefully spaced out.

With regard to the arrangement of jacks, it will be noticed that, apart from the jack already dealt with,

obvious that by using two D.E.5 valves in this manner we can obtain an approximation to the power available with a large power valve of the L.S.5 type. This is exceedingly useful, since it frequently happens that it is desired to design an amplifier which is to be used in a small hall for dancing purposes, or even for an outdoor demonstration. In this case an amplifier having two stages may not give the required volume, whilst if a further stage is added, using a D.E.5 valve in the last stage, the distortion due to overloading this valve will be quite

Push-Pull Receiver-Amplifier.—

unbearable. If, however, the push-pull principle is adopted in the third stage, using two D.E.5 valves, the problem is solved. It is unfortunate that this method of overcoming the difficulty of outdoor or "small hall" demonstration is not more generally adopted by amateurs undertaking the responsibility of these. The question may well arise as to the volume which may be expected from an amplifier consisting of a conventional first stage followed by a stage of push-pull. The answer is that quite a considerable increase in actual volume is obtainable over the conventional two-stage transformer-coupled amplifier, but less volume than would be obtainable by using three ordinary transformer-coupled stages, although of course the quality of the latter would not bear comparison with that obtainable from a push-pull amplifier. Of course in operating an amplifier of this description the usual rules concerning H.T. and grid bias must not be ignored, but it will be found desirable to use a greater value of grid bias than is customary in ordinary amplifiers, and careful experiments should be conducted. Since a tapped nine-volt grid battery is employed, this point should present no difficulty. Needless to say, the same type valve should be used in both positions of the push-pull portion of the circuit, and their filament temperatures should be controlled from a common rheostat.

The Receiver Circuit.

With regard to the receiver portion of this circuit little need be said. A simple single-valve regenerative set is employed. No departure from convention is made, but the writer would like to emphasise the desirability of employing some form of scale indicating the setting of the reaction coil, since if a given station has been received and it is desired to be able to repeat this on a subsequent evening by adjusting the instrument to the same settings, it is rather futile to turn the condenser to the same setting without having any indication of the previous setting of the reaction coil. The writer has therefore fitted the shaft of the coil holder with a geared vernier dial similar to that on the variable condenser, the dial containing two concentric knobs, giving direct drive or a 50 to 1 reduction drive. This will be found to be of very great benefit in obtaining the critical reaction control necessary for the reception of distant stations. The filament rheostats have also been fitted with indicating dials. A further useful device is the combined filament rheostat and variable grid leak on the detector valve, the leak being of really sound construction. It is provided in the receiver not so much for its variable properties in the sense of minute adjustments as for the fact that it is a convenient method of obtaining a value of 0.5 to 5 megohm according to whether

the desire is high quality reception from the local station or the reception of more distant stations. The 2 megohm grid leak has become an absolute fetish with users of wireless receivers, and yet, in the case of single-valve users especially, amateurs would find that if they abandoned their conventional 2 megohm leak for one of higher value, say, 3 to 5 megohm, they would be greatly surprised at the really considerable increase of range which would accrue to their receivers. When

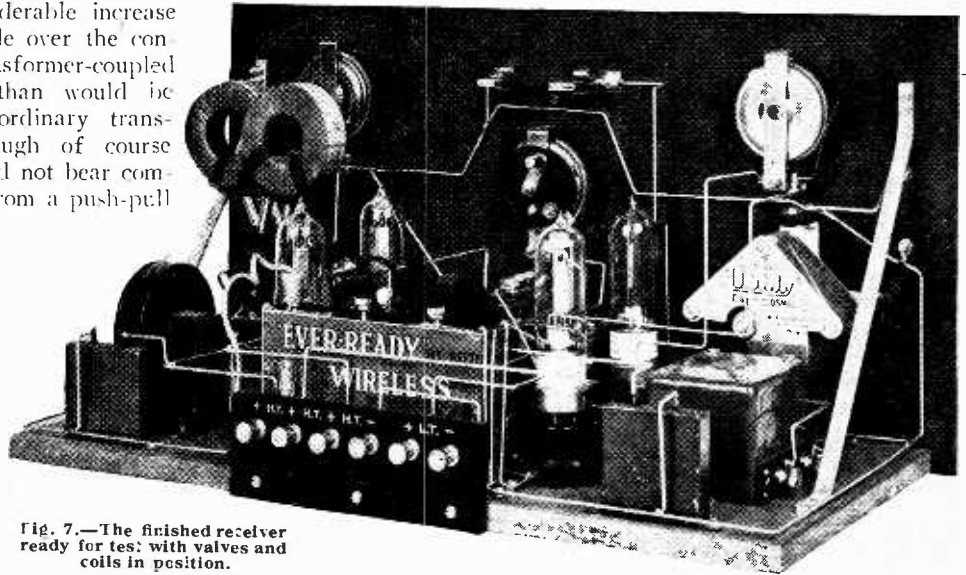

Fig. 7.—The finished receiver ready for test with valves and coils in position.

quality from a near-by station is the main consideration, however, a leak of half or even a quarter megohm will be necessary. If this point is attended to, amateurs will find that the need for anode or crystal rectification need no longer be entertained, except in cases where the last ounce of purity is desired. It is well to remark, however, that it is better to go to the trouble of providing two or three fixed grid leaks, which may be clipped in as desired, rather than to employ an inferior grade of variable grid leak.

External By-Pass Condenser.

It will be noticed that no fixed condenser is shown shunted across the primary of the first transformers. The reason is that, as previously pointed out, a special jack is provided, so that any other type of receiver may be used in conjunction with any type of receiver. Now in the case of a receiver adjusted to either the normal B.B.C. or the 5XX wavelength, the usual value of 0.001 mfd. is of sufficient capacity to by-pass the high-frequency component of the rectified current, but in the case of a superheterodyne, where the wavelength of the intermediate amplifier may be anything from 3,000 to 10,000 metres, a larger condenser will be found to be preferable, and so it is recommended that a condenser of the clip-in type be provided, so that it may be rapidly interchangeable in cases where an output from a superheterodyne is to be amplified.

A few words concerning the results obtainable with this instrument will not be out of place. Tested on the local station, using ordinary R type valves throughout, very

LIST OF COMPONENTS.

1 0.0005 mfd. variable condenser (Utility).
 1 Back of panel mounting two-way coil holder (Aeromonic).
 1 Combined 5 ohm. rheostat and variable grid leak (Igranic).
 2 5 ohm. rheostats (Igranic).
 1 0.0003 mfd. grid condenser with clips (McMichael).
 4 Base mounting valve holders (Burndept "Anti-Phonic").
 3 1 mfd. fixed condensers (T.C.C.).
 1 1st stage L.F. transformer (Gambrell).
 2 Push-pull transformers (W. G. Pye & Co.).
 2 Double-circuit filament control jacks (Edison-Bell).
 1 Single-circuit filament control jack (Edison Bell).
 1 Double-circuit closed jack (Edison Bell).

1 Telephone plug (Edison Bell).
 1 Nickel jack bush (Edison Bell).
 2 Jewell micro-g geared dials (R.A. Rothermel, Ltd.).
 1 Dekko dial indicator (Bulgin).
 4 Nickel indicating terminals (Belling-Lee).
 6 Plain terminal.
 1 Tapped nine-volt grid battery (Ever-ready).
 3 Wander plugs.
 1 Ebonite panel 18in. x 9in. x 1/4in.
 1 Terminal strip 5 1/2in. x 2in. x 1/4in.
 1 Baseboard 17 1/4in. x 8in. x 1/4in.
 Length of red-and-black flex.

great volume of remarkable quality was obtained from the loud-speaker, a comparative test indicating that the volume was considerably greater than that obtained from a normal two-stage transformer-coupled amplifier. Later five valves of the D.E.R. type were substituted, and if anything results were still more pleasing, but owing to the small margin of external resistance permissible in the L.T. leads with five of these valves, it was found necessary to completely short-circuit the filament rheostats. A far better combination for users of two-volt accumulators is to employ two D.E.2 L.F. valves as detector and first L.F. with two D.E.R., or "Wuncell" valves in the push-pull portion of the circuit. The D.E.2 type of valve requires a filament voltage of 1.8 to 2 volts and has a consumption of 0.12 amps. In cases where it is desired to get the utmost volume and the highest possible quality from the instrument for the purpose of giving an outdoor demonstration, it is recommended that the D.E.5 type of valve be used throughout, including the detector valve position, or the D.E.4 valve in the case of devotees of the 4-volt accumulator. No difficulty was experienced in bringing in three or four of the main B.B.C. stations in addition to

5XX at very good loud-speaker volume. Later the output of an efficient neutrodyne receiver (2-v-o) was connected to the amplifier portion of the circuit, and the more distant B.B.C. stations, together with several Continental stations, were received on the loud-speaker with excellent volume and quality. The single-valve receiver incorporated in this instrument was also tested separately with a pair of telephones, and with the grid leak set at a fairly high value excellent results were received from distant Continental stations. Upon reducing the value of the grid leak to the conventional value of 2 megohms, a marked falling off in range occurred. It is well to remark that it is not desirable to use too high a value of grid leak. Experiment will indicate the correct value which is most suitable for distant reception. It will usually be found to be between 3 and 5 megohms. In the case of readers dwelling in the country who purpose to use dull-emitters throughout, the use of "anti-phonics" valve holders is certainly to be recommended.

Readers who construct this instrument will find, on the one hand, that not only have they a really efficient single-valve receiver, but that they have an amplifier which, while being capable of loud-speaker results of equal quality to a three valve resistance-coupled amplifier, gives considerably louder signals for the same number of valves (general purpose valves instead of expensive high amplification factor power valves) without the disadvantages of requiring abnormal values of H.T.; and, moreover, the amplifier can instantaneously be connected up to the output terminals of any existing receiver by means of the special jack provided.

o o o o

AMATEUR TELEPHONY WITH YUGO-SLAVIA.

Successful telephony tests have recently been carried out by Mr. W. E. F. Corsham (G2UV), of Harlesden, with an amateur station (7XX) at Dalmatia, in Yugo-Slavia.



Mr. W. E. F. Corsham at his transmitter apparatus.

experts in radio acoustics since 1908



Brandes

The Table-Talker

designed with expert knowledge of acoustics

NOTE: Acoustics: the science of sound. Radio Acoustics: transforming the electrical impulse into audible sound.

The ultimate excellence of the Brandes instrument does not lie solely in the hands of the master craftsman. True, his care and ingenuity must be exercised during construction, but the basic principles are laid down for him by technical experts in the Brandes laboratories. There the secrets of acoustics are thoroughly investigated and finally built into our plans. The electrical impulse is captured by your set. Transformed to audible sound by a Brandes loudspeaker that transmitted sound is perfectly reproduced.

The new goose-neck design is the result of research in radio acoustics, which definitely establishes its value in relation to the diaphragm fitted. One feature remaining unchanged is the patent material used in the construction of the horn which eliminates any suggestion of harshness. It is now possible to control volume and selectivity with the small lever located at the rear of the base and to tune in to a finer degree. Elegantly shaped, it still has that tasteful neutral brown finish and felt-padded base. Height 18 ins., bell 10 ins.

Ask your Dealer for the Table-Talker.



Audio Transformer
Ratio: 1 to 5
17/6



Matched Tone
Headphones

20/6

30/6



The Brandola

90/6

Brandes Limited

296 Regent Street, W.1

In answering this advertisement it is desirable to mention "The Wireless World."

HATS OFF TO N·A·R·M·A·T AT THE ALBERT HALL

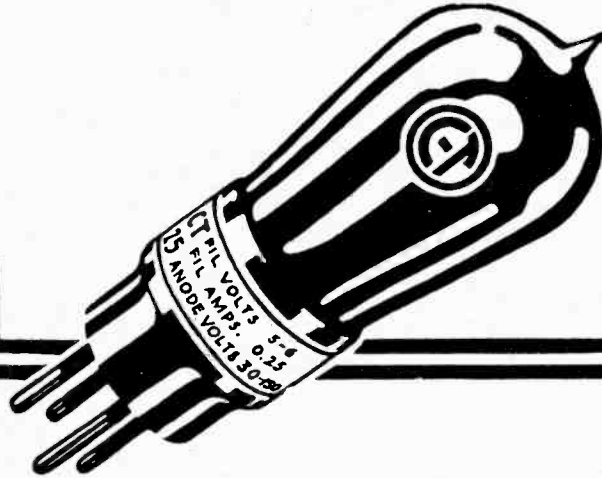

America's foremost valve made in Britain's newest factory.

C.T. 25. An every purpose volume valve. Amp. Factor 9. Price 15/-

Hats off to the N.A.R.M.A.T. for their notable Exhibition

This Exhibition has further demonstrated the supremacy of British wireless—just the reason why CLEARTRON crossed the water, with the result that America's foremost valve is now made in Britain's newest factory.

CLEARTRON Radio is British owned and CLEARTRON Valves are British made and sold under an Ironclad Guarantee of **POSITIVE PERFORMANCE** or **INSTANT REPLACEMENT**.

If your dealer does not carry Cleartron, order from us with your dealer's name and address.

CLEARTRON RADIO LTD.,
1, Charing Cross, London, S.W.1,
and Birmingham.

12/6

Phone: Regent 2331/2.

Grams: Cleartron, Westrand, London.

15/-

CLEARTRON guaranteed valves oscillate, detect and amplify. Types C.T. 08 and C.T. 15 at 12/6

Types C.T. 25 and C.T. 25B (American types C.T. 199 and C.T. 201A) at 15/-. Performance guaranteed.

CLEARTRON

BRITISH  MADE

NOVELTIES FROM OUR READERS

A Section Devoted to New Ideas and Practical Devices.

EARTHING SWITCH.

The diagram illustrates an earthing switch designed to isolate the receiver completely when the aerial system is earthed. The switch is quite easy to construct, and consists of two square ebonite blocks upon which are mounted groups of four valve legs and sockets. The valve legs are connected together in pairs by means of brass strips as shown, and the aerial and earth connections and the wires to the aerial and earth

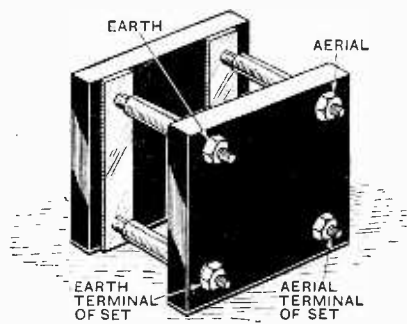

Plug and socket earthing switch.

terminals of the set are joined to the valve sockets in the manner indicated. With the plugs in the position shown, the receiver is connected through to the aerial and earth. By withdrawing the sockets and turning the front ebonite block through 90° and again making connection, the aerial will be earthed and the leads to the aerial and earth terminals of the set will be short circuited and disconnected from the receiver.—H. C. F.

o o o o

TEMPORARY FIXED CONDENSERS.

Small fixed condensers for experimental work can be constructed with short lengths of lead-covered twin lighting cable of the type illustrated in the diagram. One side of the condenser is formed by the two wires, which are bared and twisted together

at one end. The other connection is made by wrapping a short length of tinned copper wire tightly over the

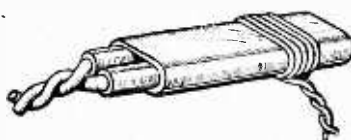

Experimental fixed condenser constructed from lead-covered lighting cable.

outer lead sleeve. Starting with a given length of cable, the capacity of the condenser may be gradually reduced by cutting short pieces off the end. When reducing the capacity the condenser must be removed from the circuit, otherwise a short-circuit will take place when the cutting pliers touch the inner wires.—C. W. P.

o o o o

PULLEY SUBSTITUTE.

If it is decided to dispense with a pulley in view of the possibility of jamming, the following method will be found an efficient substitute.

The mast is drilled to take a short length of lead piping, and is countersunk on both sides in order that the

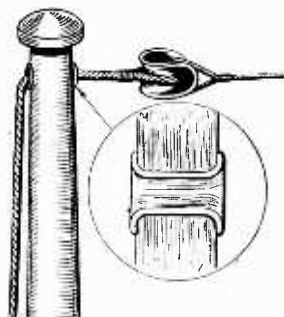

Substitute for aerial pulley.

pipe, when inserted, may be opened out at each end to grip the wood.

The soft nature of the lead reduces friction to a minimum, and effectively prevents fraying of the halyard.—F. B.

TUNED ANODE UNIT.

Experimenters who make frequent use of the tuned-anode method of coupling H.F. valves will find the unit illustrated in the diagram of great assistance in building up and testing new circuit arrangements.

A special end-plate is cut from 3/4 in. ebonite for the variable condenser tuning the anode circuit, and the anode coil holder and coupling condenser are mounted on the edge. The positions of the holes for the securing

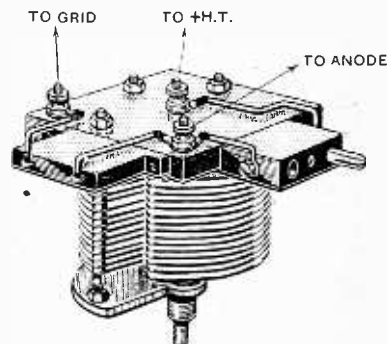

Tuned anode coupling unit mounted on condenser end-plate.

bolts for the fixed vanes and for the spindle bush may be obtained by using the old end-plate as a template.

Three terminals are provided for making connection to the other parts of the circuit. The connections between the various components in the unit are clearly visible in the diagram.—J. W. P.

o o o o

DISTILLED WATER.

When the accumulator electrolyte level has fallen through evaporation, distilled water must be added. This may be quickly and cheaply prepared in the following manner. An ordinary kettle is filled with water up to the bottom of the outlet of the spout, and the hole in the lid is sealed. The steam issuing from the

spout is conducted through a length of glass or rubber tubing to a clean glass bottle immersed in cold water and covered with a damp cloth. The yield of distilled water from this method is about one cupful every ten minutes, so that less time is taken to prepare it in this way than to make a journey to the local chemist.—F. M.

o o o o

SWITCHING H.F. VALVES.

A neat method of cutting out a H.F. amplifying valve which has the additional advantage of being proof against absent-mindedness, is shown in the diagram.

A short-circuiting plug is made with pins spaced to fit the grid and anode sockets of the H.F. valve holder. Two valve sockets with a similar spacing are fitted to the panel near the valve holder and connected in the circuit according to the diagram. Normally with the H.F.

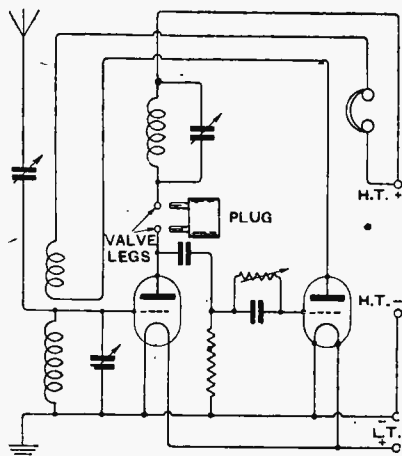

Efficient switching system for H.F. valves.

valve in use, the plug is inserted in these auxiliary sockets, thus connecting the H.T. supply to the valve. When H.F. amplification is not required, the valve is withdrawn from the valve holder and the grid and anode sockets are short-circuited with the plug. The aerial is now connected through to the rectifying condensers and leaks, and the H.T. circuit was broken when the plug was withdrawn for the purpose of short circuiting the valve holder.

The use of two condensers and leaks is a refinement, and the pair nearest the grid of the detector valve may be omitted without much loss of efficiency.—A. J.

B 16

FIXED CONDENSER UNIT.

The diagram illustrates a combination of three fixed condensers with a distributing switch giving a sequence of capacity values in steps of 0.001 mfd. between 0.001 and 0.006 mfd.

The switch includes eight contact studs and a dummy contact of insu-

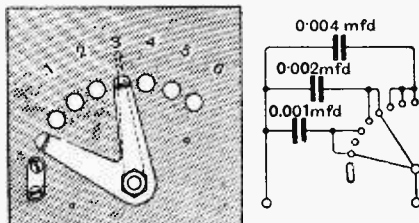

Adjustable condenser unit, capacity 0.001 to 0.006 mfd.

lating material to support the lower switch arm when in positions 1 and 2. Three fixed condensers are used which have capacities of 0.001, 0.002, and 0.004 mfd. respectively, and the connections are made according to the circuit at the right-hand side of the diagram. A pointer attached to the knob of the switch indicates the value of the capacity in circuit.—S. C.

o o o o

VALVE WINDOW.

Instead of fitting the customary round gauze window to an experimental receiver in which the valves are mounted behind the front panel, it is convenient to make use of a window consisting of a rectangular piece of ground glass. The window may be made by rubbing together with a grinding mixture of fine emery powder and water two photographic negatives from which the gelatine has been removed. The grinding process does not occupy more than five minutes, and a uniform matt surface is obtained. A convenient size of negative is 3 1/2 in. x 2 1/2 in., and a rectangular hole is cut in the panel, into which the glass may be mounted with suitable fillets.

Valves for Readers.

For every practical idea submitted by a Reader and accepted for publication in this section the Editor will forward by post a receiving valve of British make.

The matt surface of the glass is placed towards the front of the set and may be used for making pencil notes of changes in the circuit, settings of the tuning adjustments for various stations, or even for recording messages and call signs. The notes are easily erased with a damp sponge.—G. A. R.

o o o o

VERNIER ATTACHMENT.

In receivers arranged on the unit system, in which the tuner is separate from the detector and amplifying panels, the advantages of the following method of fitting a vernier condenser will be appreciated, since no alteration to the wiring of the set is necessary.

The condenser is made in two parts; a fixed plate held in the grid terminal and a moving plate and bearing bracket clamped under the filament terminal of the detector or first H.F. amplifier panel. The fixed plate may be cut in one piece from sheet brass, the projecting lug

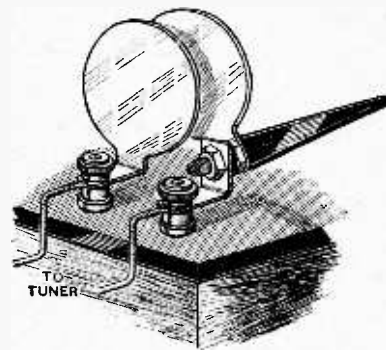

Detachable vernier condenser for fitting to A.T.I. terminals.

being slotted to fit the terminal. The bearing for the moving vane consists of a valve pin and a flush-fitting socket. The vane and a light ebonite extension handle are fixed to the valve pin, which acts as a pivot. The socket is mounted on a right-angled bracket clamped under the "Earth" or "L.T." terminal.

The split valve pin maintains an even bearing pressure which ensures smooth working, and also permits variation in the distance between the vanes. Washers may be inserted between the face of the socket and the moving vane to keep this distance constant while the capacity is being varied by movement of the extension handle in a vertical plane.—H. S. L.

22

THE SHORT WAVE.

Its Discovery, Abandonment and Revival.

By A. H. MORSE, A.M.I.E.E., Member I.R.E.

IN the beginning one Huygens, a Dutch scientist, propounded a theory that light was transmitted by means of waves. In 1864, nearly two centuries later, this theory was mathematically confirmed by that great—but all-too-short-lived—Englishman, Clerk-Maxwell. In 1888 it was experimentally proved by Prof. Heinrich Hertz, of Carlsruhe.

Discovery.

Clerk-Maxwell's confirmation of Huygens' theory was predicated upon the assumption that the waves were electro-magnetic in character; and Hertz's experiments were made with such waves of an invisible order of length—that is, many times longer than the longest which reveal themselves as red in the solar spectrum. It is true that, in 1879, an Englishman named D. E. Hughes made experimental use of these waves, and also that in 1883 another Englishman named Fitzgerald disclosed a method of producing "Electro-Magnetic Disturbances of Comparatively Short Wavelengths,"¹ wherein it was shown how to generate waves of a length of two metres. However, both Hughes and Fitzgerald seem to have been a decade ahead of their time, for the attention of experimental scientists was not directed to this field of research until well on in the '90's. Then, Hertz's experiments becoming known, such men as Lodge and Rutherford in

In view of the fact that the application of the laws of optics to what are now known as Hertzian or "Radio" waves increases in difficulty as the length of wave increases, it is not surprising to note that the very early experimenters—who, moreover, had not the means to generate long waves—made free use of parabolic and other reflectors, etc.; albeit they had no means of producing *persistent* radio-frequency waves of any length. Thus we find that Hertz used a transmitting arrangement as shown in Fig. 1, and a detector or "resonator" of the well-known ring form, as in Fig. 2. By means of the former he was enabled to project a beam, and by means of the latter he was enabled to measure the length of the waves of which it was constituted.

Righi's method of generating and detecting short waves is illustrated in Fig. 3, wherein the oscillator is marked F, and the detector L is a parabolic mirror in the focus of which are two strips of silver foil, separated by a diamond cut. Across this cut, sparks take place, which may be seen through the eye-piece K. It is recorded that by means of this device Righi generated and observed waves of from one to eight inches in length.

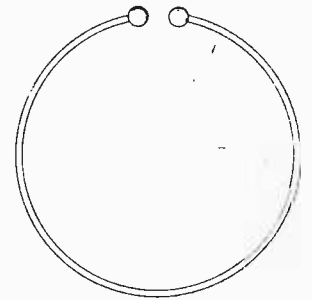

Fig. 2.—The detector or "resonator" of Hertz.

Abandonment.

It was not until 1892 that anyone appears to have considered the possibility of using short (or any other) radio waves for telegraphy, but in that year Sir William Crookes made the following statement in *The Fortnightly Review*:—"Rays of light will not pierce through a wall, nor, as we know only too well, through a London fog; but electrical vibrations of a yard or more in-wavelength will easily pierce such media, which to them will be transparent. Here is revealed the bewildering possibility of telegraphy without wires, posts, cables, or any of our present costly appliances. Granted a few reasonable postulates, the whole thing comes well within the realms of possible fulfilment. At present experimentalists are able to generate electric waves of any desired length, and

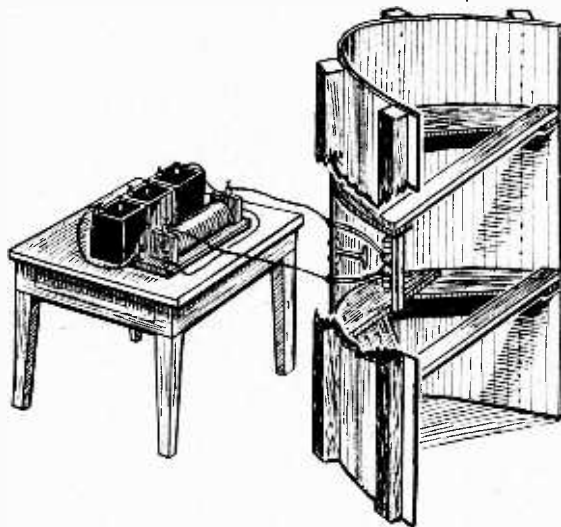

Fig. 1.—The Hertz transmitter.

England, Righi and Marconi in Italy, Popoff in Russia, and others, were moved to interest themselves therein.

(The reader who may have not yet fully grasped the fact that all the waves used in "Radio" are identical in character with those radiated by the sun, would do well to study Sylvanus P. Thompson's lecture on the "Invisible Spectrum."²)

¹ See Proc. British Association, 1883.

² *Light, Visible and Invisible*, Macmillan, 1897.

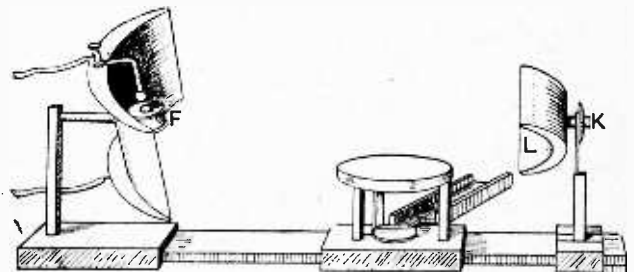

Fig. 3.—Righi's method of generating and detecting short waves.

The Short Wave.—

to keep up a succession of such waves radiating into space in all directions. It is possible, too, with some of these rays, if not with all, to refract them through suitably shaped bodies acting as lenses, and so direct a sheaf of rays in any given direction. Also, an experimentalist at a distance can receive some, if not all, of these rays on a properly constituted instrument, and by concerted signals messages in the Morse code can thus pass from one operator to another" (see pp. 197, 198, Fahie's "History of Wireless Telegraphy," Blackwood).

Again, in 1895, it is recorded of Prof. Popoff, of St. Petersburg (now Leningrad), that he transmitted the words "Heinrich Hertz" by means of the Morse code and Hertzian or "Radio" waves.³ Then, in 1896 we have Marconi proposing the use of reflected short waves for telegraphic purposes (see Fig. 4)⁴; but in the following year, when he filed his "complete" specification, he appears to have had more faith in longer waves, although he mentions having used waves of 10in. in length; and in 1899 we find Ferdinand Braun preaching

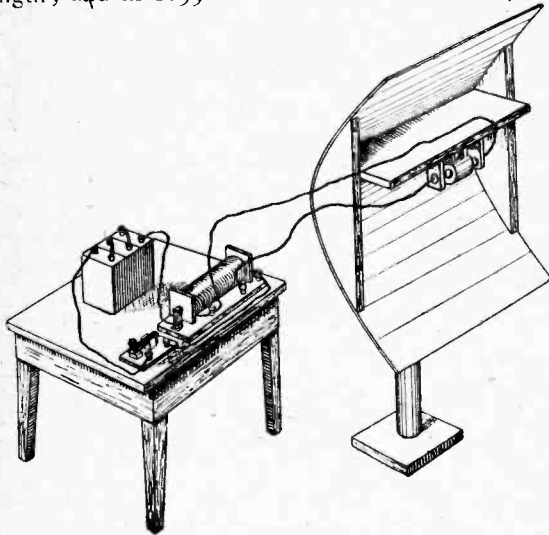

Fig. 4.—The scheme employed by Marconi in 1896

the gospel of the longer wave.⁵ Meantime Tesla had disclosed efficient methods, which are still in use, for the generation of damped trains of waves of almost any length.⁶

If he be a layman, the reader may ask how the very great efficiency of short waves has so long awaited recognition. The answer is "It has not." "One swallow does not make a summer." Neither does one wave make a signal, and until comparatively recently it has not been possible to generate more than about one short wave at a time. A single wave is about as useless as a single tooth; for the art of efficient radio communication turns upon the cumulative effect of resonance, whereby feeble but persistent and resonant impulses create astonishing effects. Occasional and irregular impulses are useless, particularly in short-wave working. An oscillating system

having such a minute time-period as is necessary for the production of really short Hertzian waves obviously cannot have much energy capacity. If, therefore, it is to be of practical use as a transmitter, it must be excited by persistent oscillations of ultra-high and appropriate frequency. But, although a generator of such oscillations was evolved by Meissner, in Germany, in 1913, it found no extensive application—as such—until some ten years later. In the early experimental days of radio the instrumentalities available were sufficient only to demonstrate the potentialities of short Hertzian waves and their identity with light waves; they were of no use for syntonic commercial telegraphy. The shorter the wave the more persistent it must be, for on persistence depends not only efficiency, or range, but the equally vital quality of syntony; in fact, in successful short-wave working the latter is not merely an ideal, but an achievement. Neither the arc⁷ nor the alternator could be made to generate waves which could be described as "short"; and the various "spark" methods of generating radio-frequency waves were out of the question, because of their irregularity. Thus, the short wave, for practical purposes, was still-born.

Revival.

The growth of the use of "spark" telegraphy naturally led to a wider technical interest in the subject. As a consequence, there came into existence an ever-increasing number of amateur experimenters, who began to saw the ether with their raucous and more-or-less untuned apparatus, until control became inevitable. The Navy, Army, Post Office, commercial radio companies, and amateur experimenters were all demanding all they could get of available wave-bands, and in the queue which eventually lined up for formal ethereal allotment the amateur was at the wrong end. He thus became possessed of what the others did not want, and that is how he acquired the right to experiment with short waves. To that fact, and the subsequent development of the thermionic valve as a generator of very high-frequency oscillations, we undoubtedly owe much of the progress which has in recent years been made in short-wave technique; for the amateurs became legion, and they practised a free interchange of knowledge hitherto unknown and seldom practicable amongst professionals.

In 1913 Dr. Alex. Meissner, of Germany, by means of the thermionic valve⁸ succeeded in generating persistent or continuous waves of a length of only 5 metres; and in 1919⁹ C. S. Franklin, of London, commenced experiments with the same device with a view to continuing the short-wave experiments, initiated by others with cruder apparatus some thirty years earlier.

Now "everybody's doing it," and intermittent two-way communications by amateurs over long distances and by means of very low power are almost commonplace. In fact, we often read of such communications between places that are literally poles apart, by the use of no more energy than may be derived from a lamp-socket. These

⁷ It is claimed that the arc has recently been adapted to generate 200-metre waves on low power. See "Q.S.T.," Jan. and June, 1925.

⁸ Vol. 73, p. 702, *The Electrician*.

⁹ Marconi, Vol. 72, *Journal R.S.A.*, p. 610.

³ See *Wireless World*, May 6th, 1925.

⁴ Br. Pat. 12039/96.

⁵ Br. Pats. 1862 and 22020 of 1899.

⁶ Br. Pats. 8575 of 1891 and 20981 of 1896.

The Short Wave.—

results, moreover, are accomplished by broadcast, as distinct from "beam," methods.

The deductions that may be drawn from the foregoing are manifold, and the chief is that there is little or no useful economy in power to be expected from the use of "beam" transmission over any really great distance—the "beam's" practicability for long-distance¹⁰ working has yet to be demonstrated. Another is that unless the beam (as popularly understood) is restricted very much in its angular measurement, it can, as such, serve very little useful secrecy purpose, because of its great range. Take, for instance, the case of a 30° beam of radiant energy of the order of 30 kW.: there is reason to believe that such a beam, when it is effective at all, will persist until it encircles and envelops the earth, and is detectable at any point. Even broadcast short-wave signals, that are measured at the transmitter in terms of mere watts, are reported to be quite strong in the Antipodes. Therefore, there may be found to be no useful result, either in the way of secrecy, or ether or power economy,

in using a 30° "beam" for long-distance communication. In fact, for the foregoing and other reasons, it seems likely that long-distance communication will be little aided by the "beam" method, as distinct from that proposed many years ago by Brown,¹¹ Stone,¹² Blondel,¹³ Braun,¹⁴ and others, a brief review of which follows.

S. G. Brown proposed in 1899 that the aerials should be a distance apart "conveniently half that of the Hertzian wavelength, such an arrangement causing the positive radiating wire to supply the positive crest of the wave at the same time as the negative radiating wire supplies the negative crest of the wave, and the waves to

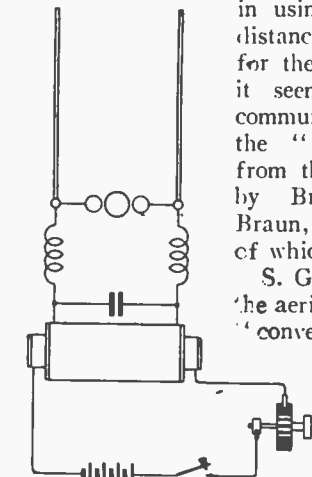

Fig. 5.—An arrangement put forward by S. G. Brown in 1899.

be thus transmitted or received mainly in the direction of the plane of the radiating and receiving wires." See Fig. 5.

In the specification of Stone's development of this method in 1902, the inventor says that the principle employed is one that "is the electrical analogue of the phenomenon of interference in sound and light." At about the same time the matter engaged the attention of Blondel, who secured a claim on "a radiator system for wireless telegraphy characterised by the combination of two or more practically parallel aerial or mast wires, the distances and phases of which are chosen dependently on the wavelength of the oscillations of the radiator, so that the Hertzian waves respectively radiated by said aerial

or mast wires are concordant in phase in that plane in which the energy is to be transmitted, and are annulled in a perpendicular plane as hereinbefore described." (See Fig. 6.) Which would not be bad practice, even in 1925.

This same method is also employed by Braun in his 1904 invention, which—according to his American speci-

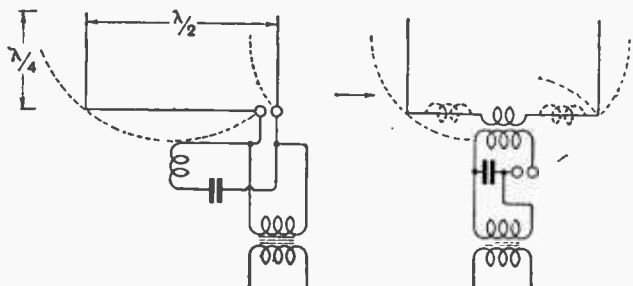

Fig. 6.—Stone's system, described in 1902.

fication—is especially advantageous "in connection with transmitting stations with several transmitting wires oscillating in different phase for radiating the waves in a definitive direction."

After 1904, for over a decade there seems to have been no further attempts to make use of what may be called "optical phenomena" in radio. But when Meissner had disclosed a method of generating persistent short-waves, interest in the subject seems to have revived. Thus, in 1916 we find Marconi applying for a patent on a tuned parabolic reflector,¹⁵ and in the following year he joins forces with Franklin in an application for a patent on a device of a similar nature.¹⁶

But in 1917 we find Alexanderson reverting to the principles exploited by Blondel and others, and claiming to have invented a method whereby he can obtain "a directional effect comparable with the focussing of a beam of light by a lens or mirror."¹⁷ He is followed by Franklin,

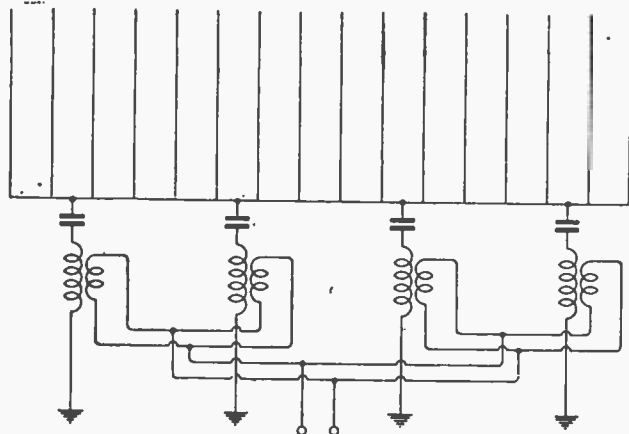

Fig. 7.—The Franklin arrangement of 1923.

in 1923, with a somewhat similar device plus a tuned flat reflector (see Fig. 7—reflector not shown).¹⁸

The second decline of interest in parabolic reflectors which may now be noticed is due largely to the well-

¹⁰ In the language of radio, "long-distance" must now be interpreted as of the order of 12,500 miles—or half-way around the earth.

¹¹ Br. Pat. 14449/99.

¹² U.S. Pats. 716134-5-6, etc., Br. Pats. 27739-42/1902, etc.

¹³ Br. Pat. 11427/03.

¹⁴ U.S. Pat. 776380.

¹⁵ Br. Pat. 105909 (void).

¹⁶ Br. Pat. 128665.

¹⁷ Br. Pat. 130064.

¹⁸ Br. Pat. 226246.

The Short Wave.—

and long-known difficulties attendant on the use of such reflectors in conjunction with any but very short waves. However, its early revival may be expected, for there is little doubt that the "short" wave of to-day will tomorrow be considered long; moreover, when really short waves come to be used they will most certainly find wide practical application. They will, for instance, be used in connection with both telegraphy, as proposed by Crookes in 1892, and aids-to-navigation, as proposed by Marconi in 1899.¹⁹ Already, by their use with reflectors, etc., it is possible to provide almost certain automatic warning of the danger of collision between ships at sea; but unfortunately this is not yet done.

Obviously, the field for development and research is as great as ever it was. The thermionic valve—for which we have to thank Edison, Fleming, and De Forest—has truly been an Aladdin's lamp to the radio engineer; and, in the able hands of such men as Armstrong, Franklin, Marconi, Meissner, and Round, we may expect it to light

the way still farther into the unknown. As an example, it may be the means of making feasible the generation of circularly polarised waves, as proposed by Herr Zehnder in 1894.²⁰

It is certain that, with the development of short-wave technique, we shall soon be able to enjoy secrecy of radio communication and practise ethereal economy to an extent that will solve many present difficulties and still further increase the great debt that mankind owes to radio.

Meantime it should be remembered that, scientifically, "beam" is a meaningless term. Hitherto it has been known mainly as a product of the sun—the most powerful broadcaster in human ken. Time alone will prove to what extent the new use of the word connotes a different quality.

¹⁹ Journal I.E.E., Vol. XXVIII., p. 283.

²⁰ P. 129, Lodge's "Signalling Without Wires, The Electrician Publishing Co., 1908.

Sheffield.

(August 22nd-26th. inclusive.)

British:—2NB, 2TV, 5DA, 5KJ, 5XN, 5YK, 6ER, 6GB, 6IV, 6LX, 6TD, 6VP, 5YC. *French*:—8CQ, 8CW, 8GA, 8GI, 3LL, 8MP, 8NA, 8PA, 8RG, 8VB, 8VM, 8VO, 8VU, 8CAX, 8LDA, 8LDR, 8LTH, 8PAX, 8PPC, 8PRD, 8SPR, 8SSC. *American*:—1BD, 2VNG. *Italian*:—1AU, 1LP. *Netherlands*:—OAM, OKG, OPM, ORE. *Swiss*:—9RNA. *Swedish*:—SMUV. *Miscellaneous*:—WNP, WIR.

(0-v-1.) (50-120 metres.)

DOUGLAS C. BIRKINSHAW (2BFM).

Gothenburg, Sweden.

(August 1st to 16th. 1925.)

British:—2AGB, 2AV, 2CC, 2DF, 2IN, 2KF, 2NM, 2SG, 2XY, 2VX, 5DM, 5LF, 5NN, 5OK, 5QV, 5SZ, 6AH, 6AS, 6DO, 6KK, 6LJ, 6MP, 6RM, 6TM. *French*:—8BF, 8CC, 8CT, 8CZ, 8DDA, 8ED, 8EV, 8EE, 8FQ, 8FIR, 8HU, 8HV, 8KL, 8LAC, 8MAQ, 8QQ, 8ZZ, YZ. *Dutch*:—OBA, OCA, OCO, OFP, OGN, ORM, OSG, OSK, OBN, PCMM, PCUU. *Belgian*:—4OR, 4RE, 4TC, 4YZ, P2. *Italian*:—1AS, 1BS, 1CC, 1ER, 1GN, 1MT, 1UV. *Swiss*:—9MM. *Scandinavian*:—SMUK, 2NM, FAR, FEC, 7DX, 7ZM. *Russian*:—RDW. *American*:—1AMS, WIZ, WQN. *Miscellaneous*:—3CA, GDI, S5RR.

GEORG HOLMLUND,
SMZN.

Horncastle.

(August 1st—17th.)

British:—2CC, 2VX, 2XY, 2GO, 2DX, 2BDY, 2NM, 5CT, 5UW, 2XY, 2LZ, 6YX, 6RM, 6JV, 6AH, 6MP, 5ZHC. *French*:—8ALG, 8FQ, 8BF, 8EE, 8GW, 8CHR, 8CT, 8PRD, 8GI, 8RCR, 22E, 8VU, 8CAX, 8TVI, 8PR, 1E, 8CS, 8BN, 8WAG, YZ, 8JBR, 8CH, 8KC, 8DT, 8RBF, 8GRA, 8PAX, OCDJ, 1E. *American*:—LAC, 1ABP, 1AEP, 1BQ, 1PL, 1CM, 1UW, 1ARH, 1BZP, 1AR, 1BTR, 1SA, 1CK, 1CKP, 1AAY, 2WC, 2BKR, 2GK, 2CX, 2MU, 2AXF, 2WR, 2BYN, 2PD, 2LC, 3JW, 3RF, 4AF, 4JA, 4KQ,

B 20

Calls Heard.

Extracts from Readers' Logs.

4UX, 4SA, 4RL, 4TV, 4HA, 4IR, 4DU, 4AS, 4ER, 4GT, 9CCA, 4FF. *Dutch*:—OPM, OZA, OXW, OFP, OAAA, NO, OKH, PCMN, 2PZ. *Italian*:—1EG, 1BN, 1AM, 1BS, 1GN, 1AU, 1MT. *German*:—K1W, KXH, KXOX. *Belgian*:—B7, 4RL, 2R, 4TI. *Spanish*:—EAR13, EAR20. *Swiss*:—9BR, 9NAZ. *Swedish*:—SOK, SGC, SMXX, SMLZ, SMNE. *Danish*:—7UB, 7EC. *Czecho-Slovakia*:—7XX. *Others*:—3CA, 2SP, WIR, WIZ, WQN, ABC, RCRL, KDKA, WGY, Q4BY, C1AR, OZX.

30—150 metres.

A. E. LIVESEY.

Thornton Heath.

(August 2nd to 17th.)

British:—2CC, 2DF, 2IH, 2IN, 2JU, 2KF, 2LZ, 2NM, 2XY, 2YQ, 5BV, 5HX, 5NJ, 5NN, 5QV, 5SI, 6AH, 6DO, 6KK, 6MP, 6RM, 6TD, 6TM (all c.w.). *Telephony*:—2KF, 2NM, 6AH. *French*:—8AQ, 8BN, 8CZ, 8FQ, 8QQ, 8TM, 8TOK, 8UOU, 8WAG, 8YK, 8ZA, YZ. *Belgian*:—4RS, E2. *Dutch*:—OBA, OPE, ORM, OXW, PCNM, PCUU. *Irish*:—1R7AR. *Danish*:—7EC. *U.S.A.*:—1AAO, 1ACI, 1ARE, 1ARH, 1AZL, 1CAB, 1CKP, 1CMP, 1KA, 1MY, 1PL, 1ZW, 2AFN, 2AGB, 2BBX, 2BFE, 2BKR, 2CTH, 2HA, 2LU, 2WC, 3AHA, 4RL, 4SA, 4TV, 5KC, WIZ. *Chilean*:—1EG. *Mesopotamian*:—1DH (c.w. and telephony).

(0-v-0. All on 30-50 metres.)

W. A. J. WARREN.

Halifax.

(Below 50 metres.)

British:—2BR, 2QM, 2VO, 2VX, 2YT, 5DH, 5MA, 5QV, 5SZ, 6AH,

6FG, 6MP. *French*:—8ALG, 8AG, 8AZ, 8BF, 8BN, 8EE, 8FQ, 8HU, 8IG, 8IN, 8KL, 8LAC, 8PRI, 8QQ, 8TOK, 8YK, YZ, OCDJ. *Danish*:—7AR, 7FP, 7ZM. *Swedish*:—SMZV, SMZS, SMXU. *Dutch*:—OBX, OGN, OPM, OZA, 2PZ. *Belgian*:—B2K, B6G. *Italian*:—1RT, 1NA. *Mexican*:—1DH. *New Zealand*:—2AE. *Australian*:—2CM, 3BQ. *Spanish*:—3CA. *American*:—1ANA, 8CCQ, 8SF, WIZ, WQN, WBZ. *Russian*:—RDW. NRRL at Wellington, N.Z.

(0-v-0.)

JOHN W. JAGGER.

Lincoln.

Under 100 metres (indoor aerial and indoor counterpoise).

PCUU calls ANF; RDU (Russia) calls CQ; AGA calls LPZ; PCMM calls PKX; CA calls ICC; WIZ, WQN and WIR call ABC; 1MT (Italian) calls CQ; 1SF (American) calls CQ; OSV (Holland) calls CQ; D49A calls CQ; 2SZ (English) calls A4Z; 6TM (English) calls test.

About 180 metres (outside aerial).

2II, 2TN, 2QN (6SA telephony).

(0-v-1 Reinartz.)

RALPH BATES (5OD).

Glasgow, W.2.

August 14th (below 50 metres).

British:—5DH, 5TZ, 6KK, 6TM, 6LJ. *Belgian*:—4RE. *Dutch*:—OAS, PCMM, PC7. *American*:—1BUS, 1UW, 1AEP, 1CH, 2BRB, 4RL, 4ER, WIZ, WQN. *French*:—8CA, 8SS1, 8ALG. *Scandinavian*:—D7EC, S2NM. *Cuban*:—2BY. *Russian*:—RDW. *Miscellaneous*:—Y7XX, POF, RAF4, 9CH.

L. HOTINE.

G2QM.

NOTE.—We would ask readers when sending us their reports of calls heard to group them under their respective countries and to confine their lists, as far as possible, to distant stations or those of exceptional interest in neighbouring countries. The space available for publishing these lists is very limited and, in consequence, those containing a large number of obvious stations have often to be omitted.

CURRENT TOPICS

News of the Week — in Brief Review

SIMULTANEOUS BROADCASTING IN FRANCE.

The experiments which have been conducted recently for simultaneous broadcasting between "Petit Parisien" and Radio Toulouse stations have been highly successful and as additional stations are set up in France it is proposed to extend this method of exchanging programmes.

o o o o

LONG DISTANCE DRY CELL TRANSMISSIONS.

A report has been received indicating what can be accomplished with small power transmitters when only dry cells are used for aode potential.

5LS, of Blackheath, operated by Mr. R. W. Bloxham, has been heard on telephony by 5NJ, of Whitehead, Co. Antrim. 5LS was employing only six watts, high tension being supplied by 200 volt dry batteries and the valve used being a D.E.5B.

Telephony transmission and reception took place on September 6th in broad daylight on a wavelength of 45 metres.

Another event of equal interest is that 5NJ, operated by Mr. F. R. Neill, was in return clearly received on telephony by Mr. Butement, 6TM, of London on the 14th, September, when the input was measured as approximately six watts. The wavelength was again 45 metres.

o o o o

GOVERNMENT CONTROL IN DENMARK

The Government is taking control of all branches of broadcasting activity in Denmark for a period of one year. A committee consisting of 25 members and composed of Government representatives, delegates from various wireless firms and interests, the press and musical representatives, will undertake to prepare the detail of the programmes. A licence will be required by all those who listen-in, the licence fee varying according to whether a crystal or valve set is employed.

o o o o

RADIO IN SPAIN.

Up to the present very little broadcasting interest has been shown in Spain as compared with other countries in Europe, but we learn that an International Radio Exhibition is proposed for this year, to be held in Madrid, with the object of stimulating public interest in broadcasting.

THE BERLIN WIRELESS EXHIBITION.

The second annual wireless exhibition held recently in Berlin had the distinction of being an "All German" exhibition, just as the show at the Albert Hall in London was "All British."

The outstanding impression obtained on a visit to this exhibition was that the standard of production had improved very considerably over that of the previous year, and it was noticeable that incompetent firms, of which a number were represented last year, had apparently gone out of business altogether, leaving the industry mainly in the hands of technically reliable firms capable of producing high-class apparatus.



The Berlin Exhibition Building. The Wireless tower is 400ft. high.

A number of very finely finished cabinet receivers employing eight or nine valves were on view, but these were realising only a limited sale, due no doubt to the fact that the purchasing power of the German public is still low.

o o o o

PATRON SAINT OF WIRELESS.

Some amateurs at the Naval Radio-Telegraphique School at Toulon were responsible for promoting the idea which has resulted in French wireless enthusiasts adopting St. Joan of Arc as their patron saint.

LISTENING-IN ON THE BATTLEFIELD.

It is reported from Morocco that French troops in action were recently able to entertain themselves with the programme of the London station, items being clearly heard and enjoyed.

o o o o

WASHINGTON RADIO CONFERENCE.

After frequent postponements, it is announced that the International Radio Conference will be held at Washington next spring, and Great Britain has already accepted the invitation to be represented.

o o o o

A CURIOUS RESTRICTION.

Although in Austria broadcasting is becoming extremely popular, a curious restriction has been placed on the erection of aerials. It is not permitted to instal any external aerial unless special authority is obtained. Before any receiving set is installed a Government licence must be obtained. Special control of imports of wireless apparatus has been instituted in order to protect the home industry.

o o o o

AUSTRALIAN TELEPHONY TO THE ARCTIC.

Mr. Spencer Nolo (A2YI), of Sydney, is reported to have conversed by telephony with the MacMillan Arctic Expedition, thus covering a distance of 12,000 miles. Commander MacMillan sent A2YI the following message in Morse for the Governor-General of New South Wales:—"My compliments to you from the other antipode almost halfway round the world. We are in a fairyland of ice less than 12 degrees from the North Pole."

o o o o

DEATH OF WELL-KNOWN AMATEUR.

We regret to learn of the recent death in London of Mr. George Sutton, A.M.f.C.E., whose name will be familiar to a large number of our readers. Mr. Sutton was a member of the staff of the Engineer-in-Chief at the General Post Office, and his hobby was wireless. He had for many years been Honorary Secretary of the Wireless and Experimental Association, his local society, and was known in wireless club circles throughout the Metropolis.

ITALIAN BROADCASTING STATIONS.

The broadcasting station at Milan, which is being erected for the Italian Broadcasting Co. by the Marconi Co., will be a Type "Q" transmitter with a power of 6 kW. The new broadcasting station at Rome, which is being erected by the same company, will be similar to the new 2LO and will have a power of 12 kw.

○○○○

NUMBER OF WIRELESS LISTENERS.

An official of the National Association of Radio Manufacturers has compiled the estimate of 7,000,000 as being the probable number of wireless listeners in Great Britain to-day, and this public is estimated to be spending something like £10,000,000 a year on wireless apparatus, and giving employment to 35,000 people.

○○○○

HOME CONSTRUCTORS IN GERMANY.

It is anticipated that a considerable increase in the interest in the technical side of wireless in Germany will result immediately from the fact that permission for the home construction of sets has been given as from September 1st. The licence fee for listeners in Germany remains at 2 marks per month.

The occupied Rhineland district is still without wireless receiving sets, as these are not permitted for the general public, on the ground that it is necessary to insure the safety of the troops in occupation. The newly freed Ruhr area is rejoicing in the fact that wireless sets are now permitted, and a very large number have been sold in that area where the public is able to listen-in to the transmissions from Germany and the rest of Europe.

○○○○

WIRELESS IN CHINA.

News regarding wireless developments in China is in keeping with the generally unsettled state of the country. A tangle in the wireless concessions demanded or

granted seems to have no possible solution except by international agreement. The American Minister in Peking, it is reported, has demanded the confirmation of a concession to the American Federal Wireless Co., whilst the Japanese Minister demands that a similar concession should be given to the Mitsui Co.: as a third claim, there is the concession stated to have been granted by the Chinese Government to the Marconi Co. in England. The position is reported to have been utilised by disaffected parties with the object of stirring up misunderstanding between the three nations concerned.

○○○○

GRAMOPHONES AND WIRELESS.

At the meeting of the Gramophone Co. last year, the chairman stated that he considered there was plenty of room for the gramophone and wireless industries without fear that the one would adversely affect the other. This prediction is borne out by the fact that this year an increased distribution by the Gramophone Co. has been announced, and rather than suggesting that the gramophone industry has suffered, it would seem that broadcasting has acted as a direct stimulus to interest in the phonograph.

○○○○

BROADCASTING MOTOR RACING.

The International 200 Miles Race, in which there are thirty-three competitors, will be broadcast from Brooklands Track on Saturday afternoon, September 26th.

We understand arrangements are being made to permit listeners to hear the cars as they negotiate the hair-pin bends at speed, and, in addition, to convey an impression of the race from various other interesting aspects such as the work undertaken at the cars' replenishment and repair pits.

The Earl of Cottenham has been nominated as driver of the 2nd Alvis car entered for the race.

TWO CONTINENTAL FRIENDS.

Mr. E. A. Wilson, 6GM, sends us the photograph which appears on this page of himself in the company of a Swedish and a Danish amateur. This photograph was taken in Copenhagen recently. No doubt many of our readers have worked with SMVH and 7BJ.



In good company—6GM with SMVH and 7BJ.

THE B.B.C. AND THE NATIONAL ANTHEM.

Comment was made recently in the *Morning Post* on the omission of "God Save the King" at the end of the broadcast programmes of the B.B.C., and the question was asked why wireless listeners should not have the opportunity of paying this mark of respect in the same way as the audiences of every cinema or theatre.

○○○○

THE CRYSTAL AMPLIFIER.

On page 355 of the issue of September 9th, the first paragraph in the left-hand column should read: "In switching on the battery, the Switch X need not be used regardless of the value of inductance in the circuit."

○○○○

BOOKS RECEIVED.

- "Talks About Wireless." By Sir Oliver Lodge. 276 pp. Published by Cassell and Co., Ltd. 5s. net.
- "Rundfunktechnisches Handbuch." Part I. By Dr. H. Wigge, Professor of Physics and Radio-telegraphy. Published by M. Krayn, Berlin. Pp. 339, with 563 diagrams. Price 15 marks.
- "Der Radio-Amateur (Radio Telephonie)." By Dr. Eugen Nesper. Pp. 858+xxvi., with 951 illustrations. Published by Julius Springer, Berlin. Price 27 gold marks.
- "Everybody's Guide to Broadcast Music." by Percy A. Scholes. pp. 238 with illustrations. published by Hodder and Stoughton, Ltd., London, price 3s. 6d. nett.

○○○○

A.J.S. TWO-VALVE SET.

We are asked to point out that the price of the A.J.S. 2-valve set advertised in our last issue should be £13 18s. 6d. inclusive of royalties. "Royal Extra" appeared by mistake in this advertisement.

27



A picture of a wireless unit during the "battle" near Winchester

THE RESISTANCE-COUPLED AMPLIFIER.

Design of Couplings and Valves for High Amplification.

By Dr. H. KRÖNCKE.

THAT a low-frequency amplifier with resistance coupling has certain advantages over an amplifier with transformers is so well known that it is hardly necessary to point out in detail the reasons why this should be so. They consist principally in the danger of producing natural oscillations in the coils of the transformers because of the natural capacity of those coils, and, further, in the possibility of distortion due to the magnetic properties of the iron. In spite of these disadvantages, which sometimes result in unsatisfactory reproduction, it has not been generally possible up to the present to adopt amplifiers with resistance couplings, because the degree of amplification which could be obtained by their means was inferior to that of the amplifier with transformers.

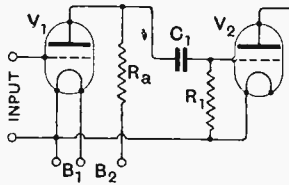

Fig. 1.—Explanatory diagram of a resistance amplifier.

In a lecture given before the German Radioclub (Deutscher Radioklub), Manfred von Ardenne recently gave an account of the work which he had done in collaboration with H. Heinert, which had for its purpose the improvement of the resistance amplifier. It can now be claimed as the result

of the work of von Ardenne and Heinert that at least the same amplification can be obtained with a L.F. resistance amplifier as with a transformer-coupled amplifier. If, now, one considers the benefits secured as regards distortionless reproduction and cheapness of construction of the apparatus, it will be realised that the advantages of the new amplifier are considerable.

The investigations of Messrs. von Ardenne and Heinert started from the view that, for the control of a valve, it is not electrical power that is necessary, but only voltage. The fact that the old transformer amplifiers have a fairly large consumption of power is made manifest by the consideration that a transformer with an iron core cannot be worked by a current below a certain strength. Von Ardenne, therefore, distinguishes between power amplification, as has generally been in use hitherto, and voltage amplification, which is in itself an aim desirable of attainment. It is only the last valve, which serves to work the loud-speaker or the telephone, which must give a certain power, since with the preceding stages of the amplifier it is only a question of obtaining a certain increase of voltage.

The Resistance Amplifier.

The parts of a low-frequency amplifier which are necessary for coupling between two stages are represented by Fig. 1, where V_1 is the first and V_2 the second valve of the amplifier. In the anode circuit of the first valve is the resistance R_a , which is traversed by an anode current

which can be calculated by Ohm's Law from the voltage of the anode battery B_2 , the internal resistance R_i of the valve V_1 , and the resistance R_a . If, now, fluctuations of potential are applied to the grid of the valve V_1 , fluctuations of the anode current are produced which cause corresponding voltage changes over the ends of the resistance R_a .

These fluctuations of potential are taken through a condenser C_1 to the grid of the second valve V_2 . In order to prevent the grid of this valve from being charged negatively, it is connected through a high resistance R_1 with the filament.

This circuit is not new, and it has been known for many years that the amplification A , which can be obtained by this circuit and which can be regarded as the ratio of the fluctuations of the grid voltage on the second valve to those on the first valve, can be expressed by the formula

$$A = \frac{I}{D} \cdot \frac{R_a}{R_a + R_i}$$

In this formula, D indicates a constant introduced by Barkhausen, which may be designated as the *Durchgriff*¹ of the valve, and is a constant which shows the increase in effect of the grid on the electrons of the valve as compared with the effect of the anode.

Factors Deciding the Amplification.

The formula contains two factors. If one wishes to make the amplification as great as possible, one must also make each of these two factors as great as possible.

Values of $\frac{R_a}{R_a + R_i}$ are illustrated in Fig. 2. It is recognised that this factor is always smaller than 1, but is

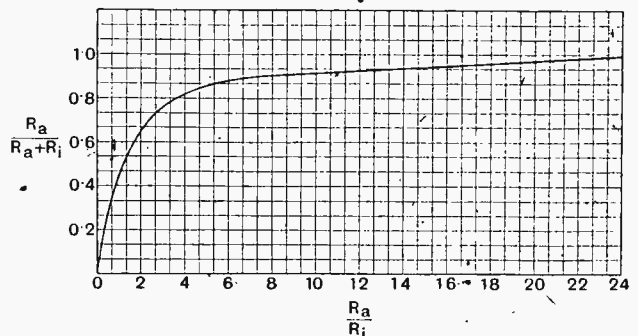

Fig. 2.—Amplification curve.

greater according as R_a is greater. This curve applies for all cases if one takes into account on the horizontal axis how much greater is the external over the internal

¹ Equal to the quantity

$$\frac{I}{V}$$

voltage amplification factor

The Resistance-Coupled Amplifier.—

resistance. If, therefore, R_a is nine times as large as R_i , it follows that $\frac{R_a}{R_a + R_i} = 0.9$. From this it will be seen that the external resistance of the amplifier should

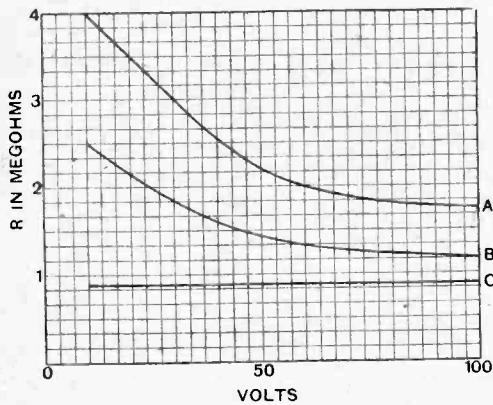

Fig. 3.—Variation of the ohmic resistance of Silit resistances (A and B) and a Loewe resistance (C) with voltage.

be as large as possible in comparison with the internal resistance of the latter.

The second factor has reference to the *Durchgriff*. The amplification becomes greater according as the *Durchgriff* of the valve is smaller (or as the voltage amplification factor is larger). The valves hitherto in use, with the exception of transmitting valves, have a *Durchgriff* of 10-12 per cent. (i.e., an amplification factor of about 10). If now, as is customary and desirable with power amplifiers, the external resistance were made the same as the internal resistance of the valve, a 5-fold amplification could be obtained, as can

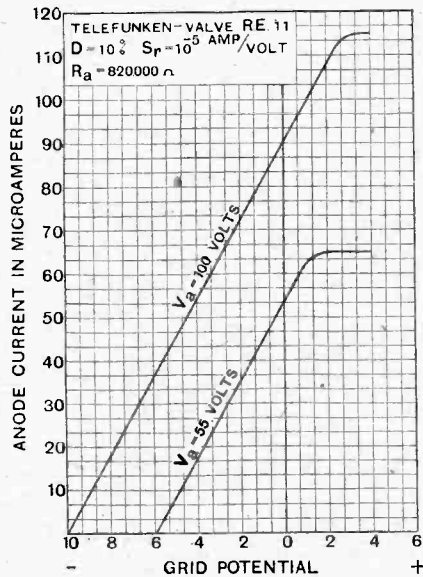

Fig. 4.—Characteristic curve of a Telefunken valve, type R.E.11.

easily be calculated. But von Ardenne and Heinert use, on the contrary, either double grid valves, with which a much smaller *Durchgriff* can be obtained, or special valves with a close grid, where the *Durchgriff* is only

about 3 per cent., and they make, moreover, the resistance R_a as great as possible. In this way they obtain with single grid valves about a 30-fold, and with double grid valves about a 50/70-fold, amplification, and this with one stage only.

Constancy of the Anode Resistance.

But to increase the resistance R_a beyond a certain value would not, however, serve any purpose. Apart from the fact that, with an increase beyond about ten times the internal resistance of the valve, no further increase in the amplification is obtained, a limit is set to the increasing of this resistance by the internal capacities of the valves and by the capacities of the leads. If now, in addition, one uses unsuitable resistance material, such as, for example, the hitherto much-used Silit rods, the natural capacity of those rods then exercises a disturbing effect to the amount of about 30 microfarads. But even if suitable resistance material without natural capacity be used, there is a certain capacity shunt in parallel with

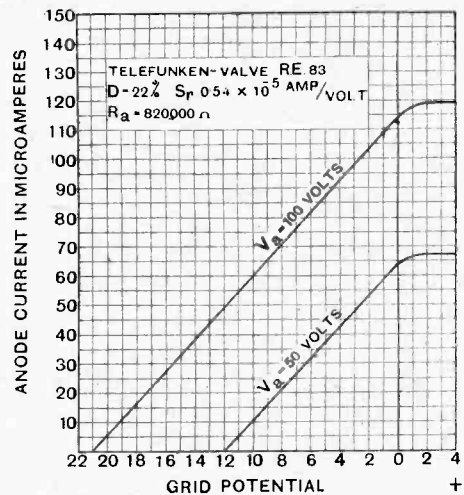

Fig. 5.—Characteristic curve of a Telefunken valve, type R.E.83.

the resistance R_a , which might be, for example, of the magnitude of 3 megohms for a frequency of $n = 1,000$. For this reason, it would serve no purpose to make the resistance R_a larger than about 3 megohms.

The choice of the resistance R_a is also of importance in another respect. The resistances hitherto in use were almost all more or less largely dependent upon the applied voltage. It is quite obvious that considerable distortion may be produced thereby. How great may be the dependency on potential in the case of Silit resistances is shown in Fig. 3, which also gives the calibration curve of a Loewe resistance. As will be seen, the resistance of the Silit rods, with a diminution of the potential from 100 to 50 volts, increases by about a quarter, and with a diminution to 20 volts by about double, whilst the Loewe resistance remains completely constant within the limits of measurement. These resistances were therefore exclusively employed for the construction of the resistance amplifiers.

The Coupling Condenser.

As far as the grid condenser C_1 is concerned, the view was formerly held that its capacity should be at least

¹ Type of resistances used in the experiment.

The Resistance-Coupled Amplifier.—

some thousands of micro-microfarads. This supposition is erroneous, as has been shown by von Ardenne and Heinert; and, since the grid current taken by the second valve is extraordinarily small, the impedance of the capacity C_1 may be very high: a magnitude of about 500 micro-microfarads is, in fact, sufficient for the purpose. According to von Ardenne, all that is required is that the capacity C_1 should be large as compared with the capacity

to which von Ardenne designates curves 4 and 5 as *working characteristics*. Whilst in the case of the ordinary characteristic one speaks of steepness, von Ardenne speaks here of *working steepness*, which therefore depends upon the external resistance of the anode circuit. This working steepness S_r can also be introduced into the formulæ given above, in the place of the *Durchgriff*, whereby one obtains for the amplification the extraordinarily simple expression $A = S_r R_a$.

As will be observed, the valves hitherto used are not very suitable for the purposes of resistance amplification. On the basis of von Ardenne's investigations, valves of a *Durchgriff* of only 3 per cent. and requiring a very small filament current have already been made. It is now intended to construct still better valves with very short filaments. Such valves would have the further advantage that the voltage drop along the filament is quite small, which would contribute at once to increasing the working steepness and consequently the amplification. Von Ardenne calculates that he will obtain at a not too distant time at least 70-fold amplification with only one stage.

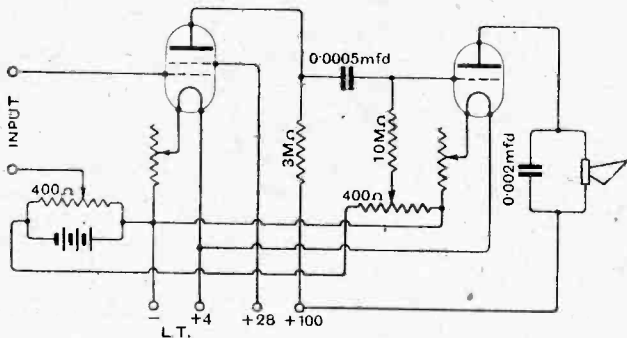

Fig. 6.—A resistance amplifier employing a double grid valve.

between grid and filament of the valve V_2 . The grid leak resistance R_1 must, however, be as large as possible, and should be 5-10 megohms.

Working Characteristics.

As the resistance R_a is 3 megohms, the internal resistance of the valve can be disregarded, and it will be seen that with an anode tension of 100 volts, a current of only about a hundredth of the anode current otherwise customary can develop. This, however, is not a reason for increasing the anode tension in order thereby to increase the anode current; rather does it show that the heating of the filament of the valve need not be greater than is required for a hundredth part of the normal electronic emission. As a result, several important advantages of this amplifier are at once manifest. In the first place, the amplifying valves can be heated with very much less current than was formerly the case. A valve with an ordinary filament needs only to be heated to a yellow glow in order to emit sufficient electrons for amplification. The advantage of this, from the point of view of the life of the valve, need not be emphasised, since a valve so slightly heated will be practically indestructible. The small emission of electrons, moreover, results in the space charge being immeasurably weaker than what was otherwise usual, since the anode potential is amply sufficient to conduct at once to the anode all the electrons given off from the filament. The consequence is that there is a surprising rectilinearity of the valve characteristics, as is shown by the examples in Figs. 4 and 5, which relate to two frequently used German valves. The values of the anode current indicated in the illustration show how weak the currents used really are, and the rectilinearity, which is of so great an importance as regards distortionless amplification, is to be ascribed solely to this. The characteristics shown in Figs. 4 and 5 must not be confused with the ordinary characteristics, which are taken without any external resistance, and as opposed

Practical Results.

The demonstrations of von Ardenne prove the correctness of these considerations. He amplified the Berlin transmissions received with a single detector with a two-stage resistance magnification, which was fitted with double grid valves (the circuit of this amplifier is shown in diagram 6), and demonstrated the Berlin broadcast transmitted with an ordinary commercial loud-speaker, this being done in the presence of a large audience. All the hearers were charmed by the purity of the reproduction, so long as the amplification was not overdone and the loud-speaker overstressed, which must always be avoided.

It is important, when using this amplifier, to apply to the grids of the valves a suitable negative bias. As

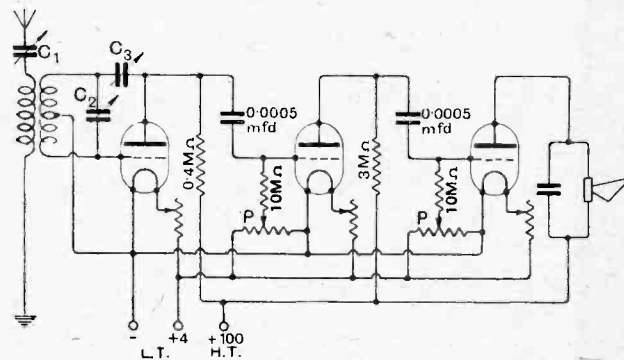

Fig. 7.—Connections of a three-valve receiver with resistance couplings.

Figs. 4 and 5 show, the working characteristics with small anode currents are rather too much displaced to the negative side of the zero grid bias potential point. In order, therefore, to work at a favourable point of the characteristic, one must apply a suitable negative bias to the grid in order that the straight part of the characteristic may not be exceeded, in which case distortion would, of course, be produced. For this reason the potenti-

The Resistance-Coupled Amplifier.—

meters shown in Fig. 6 are used. When, however, the necessary grid bias has once been ascertained by experiment, a suitable number of dry cells may be connected in circuit instead of the potentiometers.

The amplification obtained with double grid valves, in accordance with the circuit shown in Fig. 6, is only about 37-fold, notwithstanding the small *Durchgriff* of only 1 per cent. and an external resistance of 3 megohms. This is due to the high internal resistance of the valves in this circuit. The potential on the outer grid was 28 volts. The inner grid of the first valve is controlled by a potentiometer.

Finally, in Fig. 7 there is shown a receiving circuit with capacity reaction and two stages of resistance-coupled magnification. The resistance in the anode circuit of the detector valve with this circuit must not be so large as in the actual amplifier, since the first valve must have a certain power on account of the reaction. This resistance should therefore be only 400,000 ohms, and the valve must be heated normally. The last valve, which leads to the loud-speaker, must also be heated

normally, since it gives the power which is transformed into sound.

The essential advances secured by the activities of von Ardenne and Heinert consist, therefore, not only in the above-mentioned distortionless and clear amplification, but also in the fact that the amount of amplification obtained is equal to that with transformers, whilst the demands made upon the valves and the heating and anode batteries are enormously lessened. The amplifier constructed in accordance with this method, which is characterised, moreover, by a reduced cost of production, therefore combines all the advantages which can only be expected of a low-frequency transformer amplifier, and it is therefore quite probable that the idea of von Ardenne will bring about a revolution in the construction of low-frequency amplifiers as hitherto constructed. An additional advantage is that the same amplifier can also be used for high-frequency amplification, although a limit is imposed by the disturbing capacities of the valves. It has nevertheless been possible to obtain, by means of a resistance coupling, a high-frequency amplification of approximately 3-fold with a wavelength of 300 metres.

General Notes.

Mr. J. E. Fynn (G6TX), 12, Monkhams Avenue, Woodford Green, Essex, who is conducting a series of low-power tests on 45 metres, will welcome reports, and would like to get in touch with any foreign stations that will co-operate with him.

Mr. E. Megaw (G6MU), 3, Fortwilliam Drive, Belfast, has established communication on 45 metres and an input of 4 watts, D.C., with LA, 1A, Mr. J. Diesen, near Tromsøe, Norway, some 200 miles north of the Arctic Circle, and believes this to be the first occasion of working between Ireland and Norway.

Mr. J. C. Harrison (G5XY), Highcroft, Park Lane, Burnley, Lancs, offers to forward QSL cards to French 8TOK, 8ZEB, or 8ROR, and adds that there is no necessity to enclose stamps for postage.

We understand that WGK, the G.E.C., Schenectady, N.Y., are broadcasting programmes on 38 metres every day except Sundays.

Mr. A. E. Turville, 108, Abingdon Street, Northampton, states that, though he has not transmitted from his station (2XG) for more than nine months, he is still inundated with reports of Morse and telephonic messages purporting to have been transmitted by 2XG. He will welcome any information enabling him to trace the offender who is misusing his call-sign.

We would again remind our readers that the Secretaries of Radio Club Belge de l'Est, Crapanrue 56, Verviers, or of the Reseau Belge, 11 Rue du Congrès Brussels, have kindly undertaken to forward QSL cards to Belgian amateurs, but ask senders to be careful that their communications are sufficiently stamped, as they have found excess postage dues a somewhat heavy item of expenditure.

Mr. A. M. Houston Fergus, La Cotte, La Moye, Jersey, is transmitting on

TRANSMITTING NOTES AND QUERIES.

wavelengths 100 to 400 metres (C.W.) under call-sign MAG, and on 100 to 200 metres under call-sign G2ZC, and will welcome reports (especially regarding MAG).

Stations Identified.

We have received from various correspondents, to whom we tender our thanks, the following QRA's, which we trust will be of interest not only to those transmitters who specifically asked for them, but to others of our readers.

BZ1AP.—N. de B. Ignarra, Rua Cosme Velho 172, Caixa Postal 68, Rio de Janeiro.

RDW (sometimes signing NRL).—The Radio Laboratory at Nijni Novgorod, near Moscow.

OCTU.—French official station for low wavelengths in Tunis, the call-sign being an abbreviation for "Ondes Courtes Tunis."

OCDJ.—A similar station in Djibouti (QSL cards may be addressed Radio OCTU and Radio OCDJ in their respective towns).

FTJ.—French motor vessel "Jacques Cartier."

XY.—Official French station, Fort d'Issy (Seine).

LMA.—J. Diesen, Moen i Maalselv, Norway.

SOK.—Sokolniki Radio Station No. 3482, U.S.H.R., Moscow.

F8QQ.—R. Jamas, 40, Rue Bezanat, Paris, 142. This call sign is now officially altered to 8JL. Mr. Jamas, who

transmits on 37 and 44 metres, will welcome reports.

WJS.—The base station of the Rice Expedition to the Upper Amazon, operated by T. S. Caleb, Boa Vista, Rio Branco, Brazil.

JSDA and AKPKI (73 metres), of Iwatsuki, Japan. (Our correspondent is uncertain about the two final letters of the latter call sign (KI) as they were sent as one sign — — —).

Addresses of Stations Wanted.

We shall be glad if any of our readers can give us the QRA's of the following stations. (In some cases it is inadvisable to publish the names and addresses, but any replies indicating that publication should be withheld will be communicated in confidence to the enquirers):—

Great Britain:—50K, 6UG, 6ME, 5WE, 6ZK, 6YX. *Ireland*:—7AR. *France*:—8PA, 8RBF, 8NPR, 8DID, 8GRA, 85PR, 8TVI, 8PAX, 8RG, 8KR, 8RAT. *Germany*:—KL4, KAM5. *Switzerland*:—H9LD. *Denmark*:—D7AR. *Australia*:—A6DEL. *Japan*:—J2II. *Chile*:—CH2LD. *U.S.A. (U)*:—2XG, 4ASK, 2AFN, 1CME. *Sweden*:—SMRG, SMHI, SMLZ. *Holland*:—OXF, OBK, OQX, ORW, ORM, OBQ, OAM, OAW, PDA. *Italy*:—1BB. *Mexico*:—DH1. *Norway*:—NW4XYZ. *Unknown*:—FABC, VOBQ, 1AG, HK, RG, Z22, C22, Y7, IR7OV, 2LU, 2HA, Y9, OCML, PB7, P1BZ, NTER, OCML.

Misuse of Call Sign.

Mr. M. Burchill (2NS), 30, Leighton Road, Southville, Bristol, has reason to believe that another experimenter is using the same call sign, as he is continually receiving reports of transmissions by 2NS which evidently refer to another station.

Mr. P. L. Savage (G2MA) has reason to believe that another transmitter is making use of his call sign, and would be glad of any information enabling him to trace the offender:

Broadcast Brevities



SAVOY HILL

TOPICALITIES.

B.B.C. Birthday Party.

Plans are now taking shape for the celebration of the B.B.C.'s birthday anniversary in three months' time. It was at first suggested that the celebrations should take the form of a fancy dress ball at the Albert Hall, to which the public would be invited at a moderate charge per head; but there will probably be an elaboration of this proposal, and, in addition to the fancy dress ball, which is expected to take place at Olympia, wireless artists will attend, thus giving hundreds of listeners the opportunity of coming in personal contact with the "stars" of broadcasting who have worked unflinchingly to elevate and amuse the public in their own homes.

A Continental Tour.

One of the mysteries of wireless which at present no amount of scientific ingenuity has solved is the pooriness of broadcast reception within comparatively easy distance. One is moved to this reflection by the announcement that the B.B.C. intends, on October 15th, to broadcast a Continental "round the stations" programme, which will include excerpts from the best items available from various Continental stations.

Inverse Ratio.

On the other side of the picture, take Aberdeen as an example; a station which is well received in the South of England and in Scandinavia, but, strangely enough, not well in Glasgow, a distance of some 150 miles. Various theories have been advanced to account for this peculiarity, but no means of rectifying it has yet been discovered.

Aberdeen Station.

Aberdeen station, so far as the transmitter part of it goes, is one of the most ideally situated in the Northern Group. Even in face of countless ingenious stories which have from time to time been woven round the Granite City concerning the local desire to avoid investing in wireless if any outlay is involved, a thoroughly good field within the precincts of a local works was found, and two first-rate 110ft. masts erected about 200 feet apart, and a consequently excellent aerial, with symmetrical buried earth system, resulted. One of the works' buildings was then requisitioned, and from the outset the station's behaviour was exemplary.

The First.

Aberdeen station was the first in the north to begin operating on the new magnetophone apparatus.

All Clear, but—

When the station was ready for the opening ceremony on October 10th, 1923, everything was in order and no abnormal happenings were anticipated; but the weather was left out of account in this calculation. This was an unfortunate thing; for a gale of unusual ferocity succeeded in demolishing many sections of main trunk wires leading south. Up to nearly the fatal hour fixed for the start, the hopes of receiving from and sending to other places items of interest were low; but by splendid effort and spreading their activities over long tracts of storm-swept moorland, the Post Office engineers produced from the surviving lines sufficient for the immediate needs of the B.B.C.

Alternative Programmes.

Some weeks ago reference was made to the suggested use of 5XX for alternative programmes, and readers were reminded of the remarks of Lord Gainford on the occasion of the opening of the Daventry station, when he said: "The next step is obviously to make alternative services available to as many people as possible. About sixty per cent. of the population is provided now with alternative services, capable of crystal reception. We do not consider this percentage satisfactory, and we shall endeavour to improve it as soon as possible."

Easy Stages.

It may be well to point out now that in the meantime it is regarded by the officials at Savoy Hill as the wisest policy to develop 5XX by easy stages; in other words, to give it its own special programme on three evenings a week and for the rest to allow it to exercise its choice by selecting the best that offers from 2LO and other stations, while developing plans for alternative services. It may be stated quite definitely, however, that schemes for alternative programmes are receiving the fullest consideration, and the coming winter will see a remarkable development in this respect.

Preliminaries.

The question is not merely one of providing two programmes and no more in any specific area. So far as valve users are concerned, there is indeed no reason why they should not really have a choice of ten programmes on certain nights. The essential preliminary is the increase of power which would make long-distance work satisfactory, which it never has been in the past.

FUTURE FEATURES.

Monday, September 28th.

LONDON.—10.15 p.m., Opening Night of the Pavlova Season. Divertissements relayed from the Royal Opera House. S.B. to other Stations.

LEEDS-BRADFORD.—7.30 p.m., Speeches relayed from the opening of the Little Theatre, Leeds, followed by Act I. of the Opera "The Rival Poets."

Tuesday, September 29th.

ALL STATIONS.—8 p.m., "Tit-Bits" Ballot Programme.

Wednesday, September 30th.

BIRMINGHAM.—8 p.m., Liza Lehmann's Music, including "The Golden Threshold."

MANCHESTER.—7.30 p.m., Classical Dance Music relayed from Houldsworth Hall.

Thursday, October 1st.

GLASGOW.—12 noon, Presentation of the Freedom of the City of Glasgow to the Prime Minister, the Rt. Hon. Stanley Baldwin, P.C., M.P., relayed from St. Andrew's Hall.

5XX.—7.50 p.m., Acts II. and III. of the Opera "Othello," performed by the British National Opera Company. Relayed from the Theatre Royal, Glasgow.

Friday, October 2nd.

MANCHESTER.—8 p.m., "The Witness for the Defence." A four-act play to open the ZZY Dramatic Season.

Saturday, October 3rd.

LONDON.—8.15 p.m., Acts II. and III. of the Opera, "La Boheme," performed by the British National Opera Company. Relayed from the Theatre Royal, Glasgow. S.B. to other Stations (Glasgow excepted).

Obstacles

Here we come up against the old problem of fitting into the map the requirements of all the services which depend to a great or lesser degree on wireless. If broadcasting alone had to be considered, it would be the easiest thing in the world to formulate a programme system that would leave little to be desired; but the Post Office has no light task in co-ordinating the requirements of the various Government Departments and particularly of the vital services, the Navy, Army and Air Force. Further, one has only to witness the important work carried out by direction finding stations, such as Niton, to be able to appreciate the importance of wireless to the merchant marine; or the work of stations like Carnarvon to gain an insight into the part played by wireless in the nation's commercial life. All these interests have rightly to be considered before the development of broadcasting, i.e., the erection of new stations, or the increase in power of existing stations, can be sanctioned. At present we are battling against tremendous odds, and the greatest hope of listeners should be centred upon the improvement of technical facilities which will enable the B.B.C. to surmount the many obstacles that lie in the path of progress.

o o o o

Pavlova Ballet Season.

The first night of the Pavlova Ballet Season will be relayed from the Royal Opera House, Covent Garden, on September 28, when one of the most popular of all "Divertissements" will be given. In view of this relay, the second S.B. talk will be given at 9.25 instead of the customary hour of 10.10 p.m.

o o o o

"Rigoletto" from Glasgow.

On the same evening the third act of Verdi's opera, "Rigoletto," will be relayed from the Theatre Royal, Glasgow, where it is being played by the British National Opera Company.

o o o o

Recital by Donald Calthrop.

The week's Special feature, on September 30, will consist of a recital by Mr. Donald Calthrop, whose brilliant work in "Yoicks!" relayed some time ago, including the memorable broadcast speech, will not soon be forgotten.

o o o o

A Hyde Park Broadcast.

A ceremony of great interest to the public will be the unveiling of the Royal Artillery Memorial in Hyde Park, London, on Sunday, October 18. As the unveiling ceremony is timed to take place during church hours, it may be difficult, despite the wishes expressed by listeners, to broadcast the proceedings, as the B.B.C. does not favour broadcasting during these hours except in very special circumstances. If, however, the time of the unveiling ceremony is found not to clash with church hours, it is fairly certain that the proceedings will be broadcast.

B 28

Stations of the Future.

It may be predicted that any future high-power stations will be placed outside the towns at present served by a central station, so that no jamming situation in the town itself will be experienced, and so that the town valve-user will not be prejudiced. The B.B.C. will, moreover, be able to choose a site where the engineers may be sure of erecting a really more satisfactory aerial system than is often the case under present circumstances.

o o o o

Behind the Scenes.

The possibility of improving the programmes in the smaller details is being explored. Not solely on the selection of

at Bursledon, Hants and Liverpool. Crystal reception of Vienna on the Essex coast has also been reported. A listener in Cornwall says that Daventry is "almost too loud."

o o o o

Oratorio Broadcast.

A performance of "Elijah" will take place at the Central Hall, Westminster, on November 26, under the auspices of the Metropolitan Free Church Federation. Arrangements are being made for the broadcasting of a portion of this performance.

o o o o

Talks on Music.

Although the amount of chamber music that is broadcast in the future will be

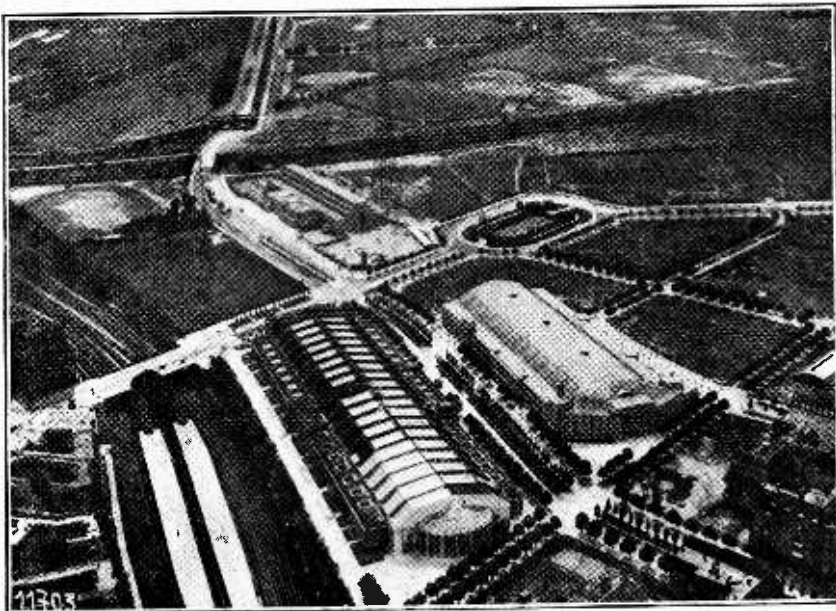

A view showing the wireless tower, and alongside the Hall in which the recent Berlin Exhibition was held.

artists does a programme depend for its success, but also on rehearsals and the minor matters of what may be described as stage management. As a first step, therefore, the number of rehearsals is likely to be increased, especially for the more important items. It is safe to assume that the success of Radio Radiance is due largely to the numerous rehearsals that have been held. Day after day the Radio Radiance artists have laboured incessantly throughout the summer in the stuffy atmosphere of the studio. This has involved virtually a twelve-hour day; but the result has amply compensated for the strenuous work that has been put into these revues.

o o o o

Daventry on Crystal.

Scores of listeners in Essex who originally complained of bad reception of 5XX have since written to the B.B.C. to the effect that reception is now much improved. The crystal reports of Daventry recently received include reports of crystal reception at exceptional strength

carefully regulated, it is not the intention to debar all attempts to improve the musical knowledge of listeners or to discourage preference for good music. In fact, a special effort will be made at the Edinburgh station, during the week beginning October 12th, for the encouragement of music, and arrangements are in hand for Mrs. Marjorie Kennedy Fraser, Mr. J. R. Clynes, M.P., and Sir Laundon Ronald to give talks on the subject. It is probable that some of the talks during this special musical week will be delivered from the London Studio, and that several of them will be simultaneously broadcast.

o o o o

Wireless Licences.

The Postmaster-General again points out in a Press notice that the legal obligation to take out a licence for a wireless receiving set has been placed beyond any doubt by the Wireless Telegraphy (Explanation) Act. Persons who have failed hitherto to take out licences should do so at once. It is proposed to institute proceedings in cases in which wireless sets are installed or used without licences.

THREE VALVE REINARTZ RECEIVER.

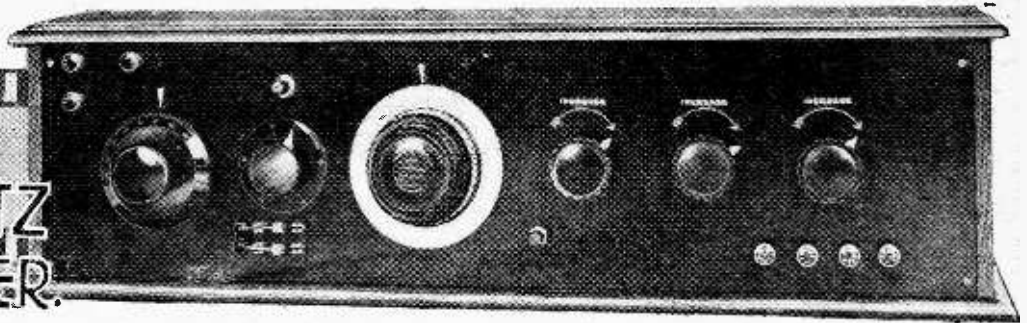

Selective Tuning with High Quality Amplification.

By A. R. TURPIN.

BEFORE commencing the design and construction of a receiver it is always a good plan to write down in black and white the features which it is desired that the finished set should possess, and, if possible, a short summary of the limitations imposed by considerations of space and economy in upkeep.

In the case in question it was required primarily that the set should be capable of receiving the local and the high-powered B.B.C. stations at loud-speaker strength with a minimum of distortion; and, secondarily, that it should be possible to cut out the local station at a distance of six miles and receive distance stations on the telephones with as few adjustments as possible.

It was therefore decided that a "Reinartz" circuit with a two-valve resistance-coupled amplifier would meet the case, because not only is this circuit one of the most selective, but the selectivity is obtained without extra controls; and, further, the control of reaction is so smooth that it may be used with ease by the merest novice.

There are, however, one or two inherent drawbacks in circuits of this type. Examples will be found in the sensitivity to hand and stray capacities; the fact that,

unless the aerial system is of low resistance, the set will not oscillate; and, lastly, the large size of high-tension battery necessary with resistance coupling.

By various modifications these drawbacks were eventually overcome, the effect of hand capacity being reduced to a minimum by mounting the condensers well away from the panel and insulating the spindles from the dials. The damping effect of the aerial may be minimised by inserting a small fixed condenser of a capacity of about 0.0001 mfd. in the aerial circuit. This does not decrease the strength of signals on the higher wavelengths to any noticeable degree, and greatly improves the selectivity.

Features of the Design.

With regard to the large value of high-tension voltage required with resistance coupling, this may be overcome by using an anode resistance for the detector valve only, and choke coupling for the second stage. Using suitable coupling condensers and grid leaks, and an inductance of approximately 100 henries for the choke, any loss in quality of tone is difficult to detect.

The complete circuit diagram is shown in Fig. 1, and suitable values are as follow:

For the anode and aerial condensers, a value of 0.0005 mfd. may be used, but the condensers must have a very low minimum, and in the case of the tuning condenser a vernier dial is a necessity, as a fraction of a degree is sufficient to cut out completely a distant station.

There are two sets of coils, one for the lower wavelengths tuning from about 300 to 600 metres, and another set comprising two plug-in coils for the higher, tuning from 1,000 to 2,500 metres. These latter are shorted by a double-pole switch when not required. The anode resistance has a

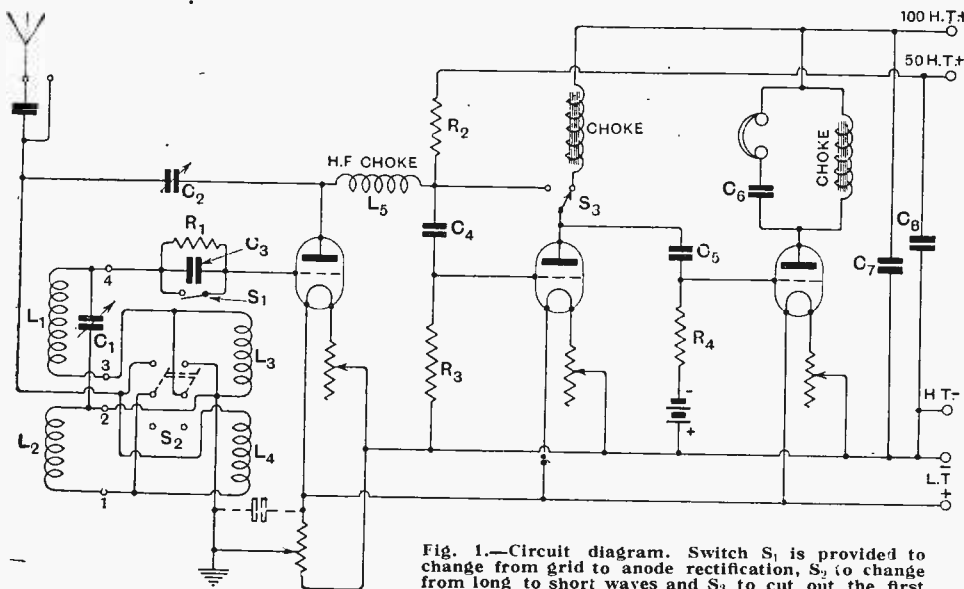

Fig. 1.—Circuit diagram. Switch S₁ is provided to change from grid to anode rectification, S₂ to change from long to short waves and S₃ to cut out the first L.F. amplifier.

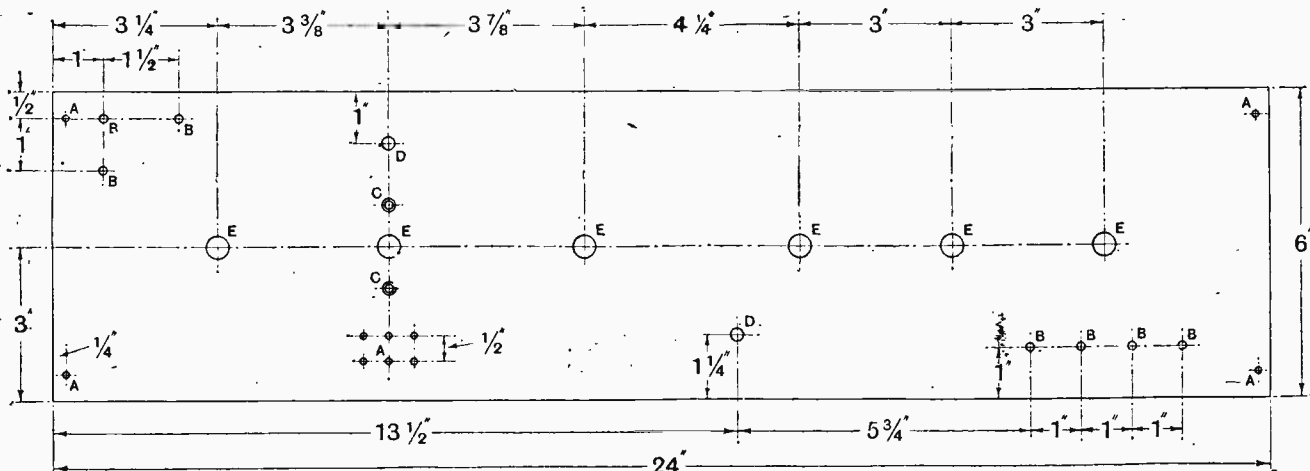

Fig. 2.—Dimensions of front panel. Sizes of holes are as follow: A, 1/8in. dia.; B, 5/32in. dia.; C, 5/32in. dia., countersunk for No. 4B.A. screws; D, 1/4in. dia.; E, 7/16in. dia.

value of about 100,000 ohms and may be purchased or, for preference, constructed by winding just over 1/4 oz. of 47 S.S.C. Eureka resistance wire non-inductively on an ebonite former.

The choke consists of the primary and secondary of a C.A.V. transformer joined in series, the coupling condensers being 0.5 mfd., and grid leaks 5 megohms.

As a power valve is used in the last stage passing an anode current of 5 or 6 milliamps, the loud-speaker is connected with a 1 mfd. condenser in series across a C.A.V. transformer with the windings in series.

In order to make certain that no high-frequency current is passed by the anode resistance, a choke coil is placed in series with it. This choke coil should be a No. 500 plug-in coil, or a larger one may be used if to hand.

For the detector a D.E.Q. valve is used. The usual H.T. voltage for this type of valve is about 30 volts, but as there will be a considerable drop in potential across the anode resistance, this should be increased to

about 50 volts. A switch is incorporated in the detector circuit, together with a grid leak and condenser, so that either anode or grid rectification may be used.

The former gives better tone quality, but the latter is more sensitive to weak signals. A D.E.3B valve was also tried as detector, and both methods of rectification gave excellent results using an H.T. voltage of 60.

When switching over from anode to grid rectification, it will, of course, be necessary to alter the setting of the potentiometer.

The potentiometer is joined across the low-tension battery, and unless the leads are disconnected from the accumulator when the set is not in use, there will be a continual discharge.

The grid leak R₁ and condenser C₃ should be the usual values of 2 megohms and 0.0003 mfd.; the switch S₁ for cutting these out is mounted above the potentiometer and is of a single-pole push-pull type.

The valve used in the first low-frequency stage should be of a type having a high amplification factor, such as

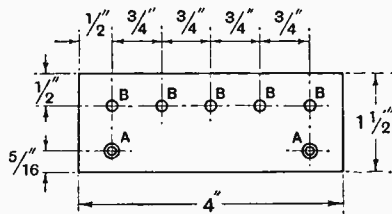

Fig. 3.—The terminal strip. A, 1/8in. dia., countersunk for No. 4 wood screws; B, 5/32in. dia.

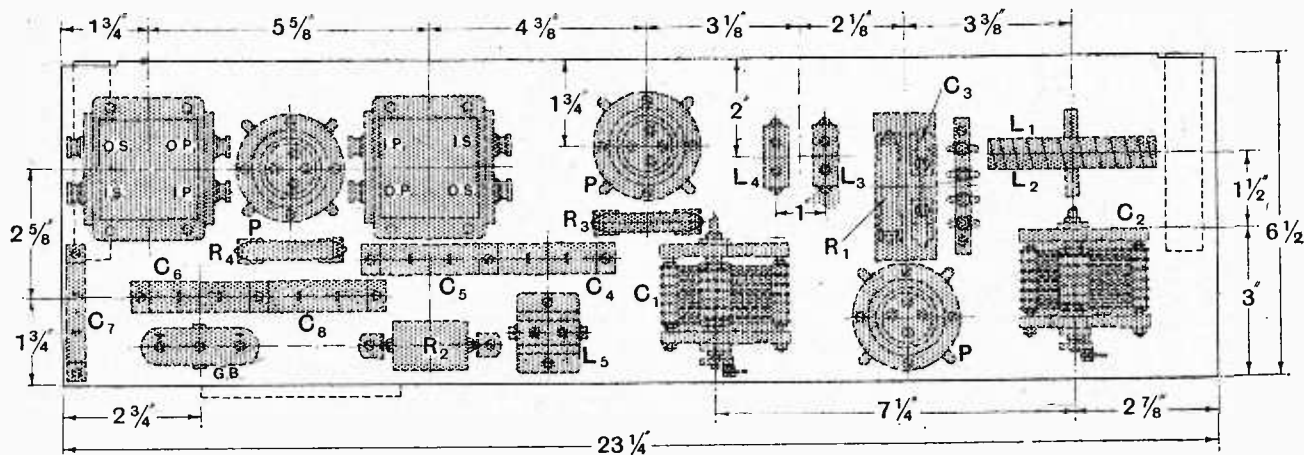

Fig. 4.—Position of components on the baseboard. The brackets supporting the front panel are screwed to the underside of the board.

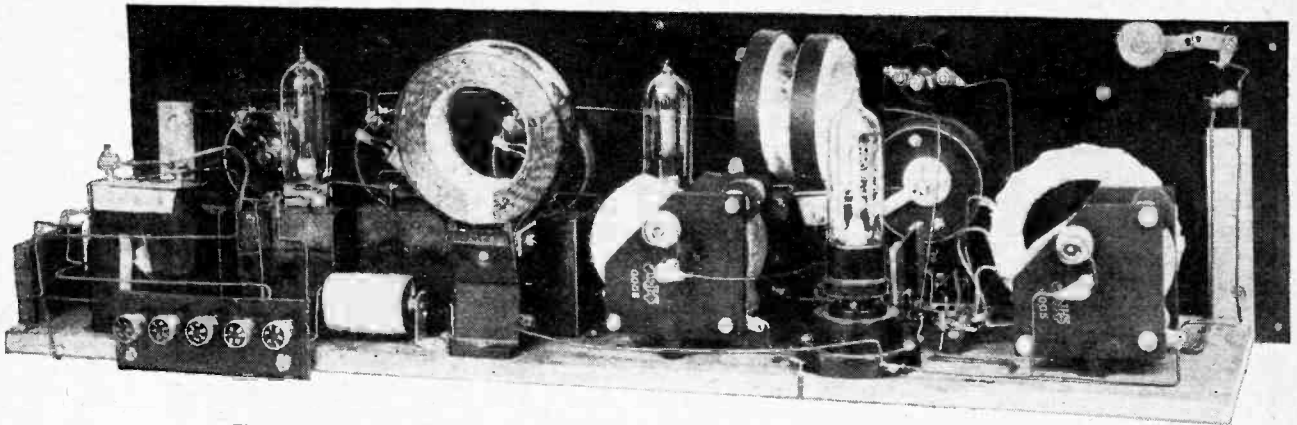

Fig. 5.—Rear view of the finished receiver with loading coils and H.F. choke in position.

a D.E.3B or D.E.5B, and a power valve such as the D.E.4 should be used in the second low-frequency stage; this is absolutely necessary if distortionless volume is required. These two valves have a common H.T. terminal and an anode voltage of 100 volts.

Battery Terminals.

If very great volume is expected, a separate terminal for the power valve should be added and the necessary increase in H.T. voltage and grid bias given.

With the above anode voltages the grid bias given to the D.E.3B valve will be of sufficient potential if the voltage drop across the rheostat is used, and for the power valve a separate 4½-volt battery is provided. Nothing can be gained by giving the first valve a larger bias, because the voltage amplification of this valve will be at least 10, and, therefore, if the voltage swing is over one volt, the second valve will be overloaded.

A switch is incorporated for cutting out the first low-frequency valve when it is desired to decrease the volume and at the same time to keep the same valves in circuit. This is done by using one three-pole switch only, and although the method used necessitates keeping the first grid leak in circuit, the great simplicity of the arrangement easily counteracts the very slight loss of efficiency resulting from this.

Reservoir condensers are placed across the H.T. terminals; a value of 1 mfd. is used for C₇ connected across the 100-volt terminal, and one of 0.2 mfd. for C₈ across the 50-volt terminal.

Separate filament rheostats are used for each valve; this is absolutely necessary, as they differ greatly in characteristics. For the first two valves a value of 25-30 ohms is sufficient, and for the last stage a resistance of 5-6 ohms is required.

Telephone Connections.

Four telephone terminals are used, the two centre ones being connected together, so that by connecting the loud-speaker to the first two, and the 'phones to the last two, they may be used in series, or by connecting to the two outside terminals they may be used alone or in parallel.

When all the three valves are in circuit, a total anode current of at least 6 milliamps will flow, so it is very necessary to use either the new type of large-capacity H.T. battery, or else accumulators, otherwise reception will be ruined by uneven discharge, or one's pocket may be treated in a like manner by continual replacements of new batteries.

The writer has often heard it stated that a Reinartz circuit is of little use on wavelengths above 500 metres,

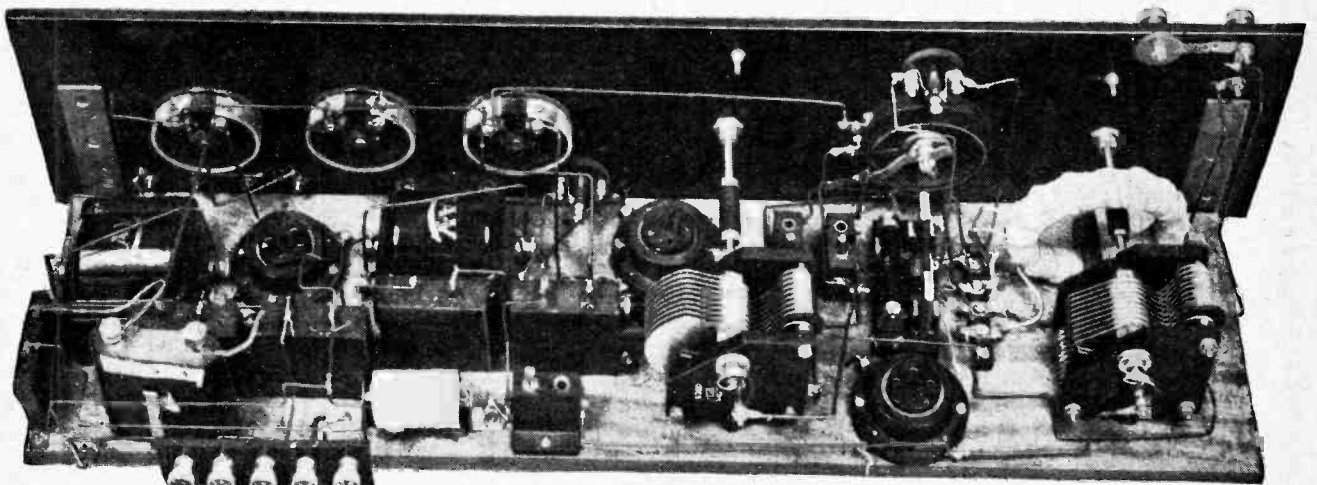

Fig. 6.—Plan view, showing condenser extension spindles and terminal strip for the combined coil L₁L₂.

Three Valve Reinartz Receiver.—

but there should be no difficulty at all in operating the set on wavelengths up to 4,000 metres providing an efficient high-frequency choke is used and a sufficiently large aerial reaction coil.

Construction.

This follows the usual practice at present in vogue; a front panel carrying the controls, and a baseboard for the valves, chokes, etc.

The positions of the dials on the panel have been dictated by the positions of the remaining components, which have been arranged to give short wiring. The appearance may not be symmetrical, but any sacrifice in

In front of the left-hand condenser and with the spindle passing through them are the low wavelength coils L_1 and L_2 . These are wound as one coil of 75 turns, with a loop at the sixteenth turn, which is cut when finished, making four ends. These ends are numbered on the diagram, the inside end No. 1, and outside end No. 4.

It is best to wind the coil in honeycomb form on a 3in. former. When completed, the coil is mounted by clamping it to the baseboard with a U-shaped piece of ebonite, and the four ends are taken to tags mounted on a strip of ebonite.

Next to this coil we have the grid leak and condenser mounted on ebonite, and leads going to the shorting switch S_1 mounted above the potentiometer. Next to this,

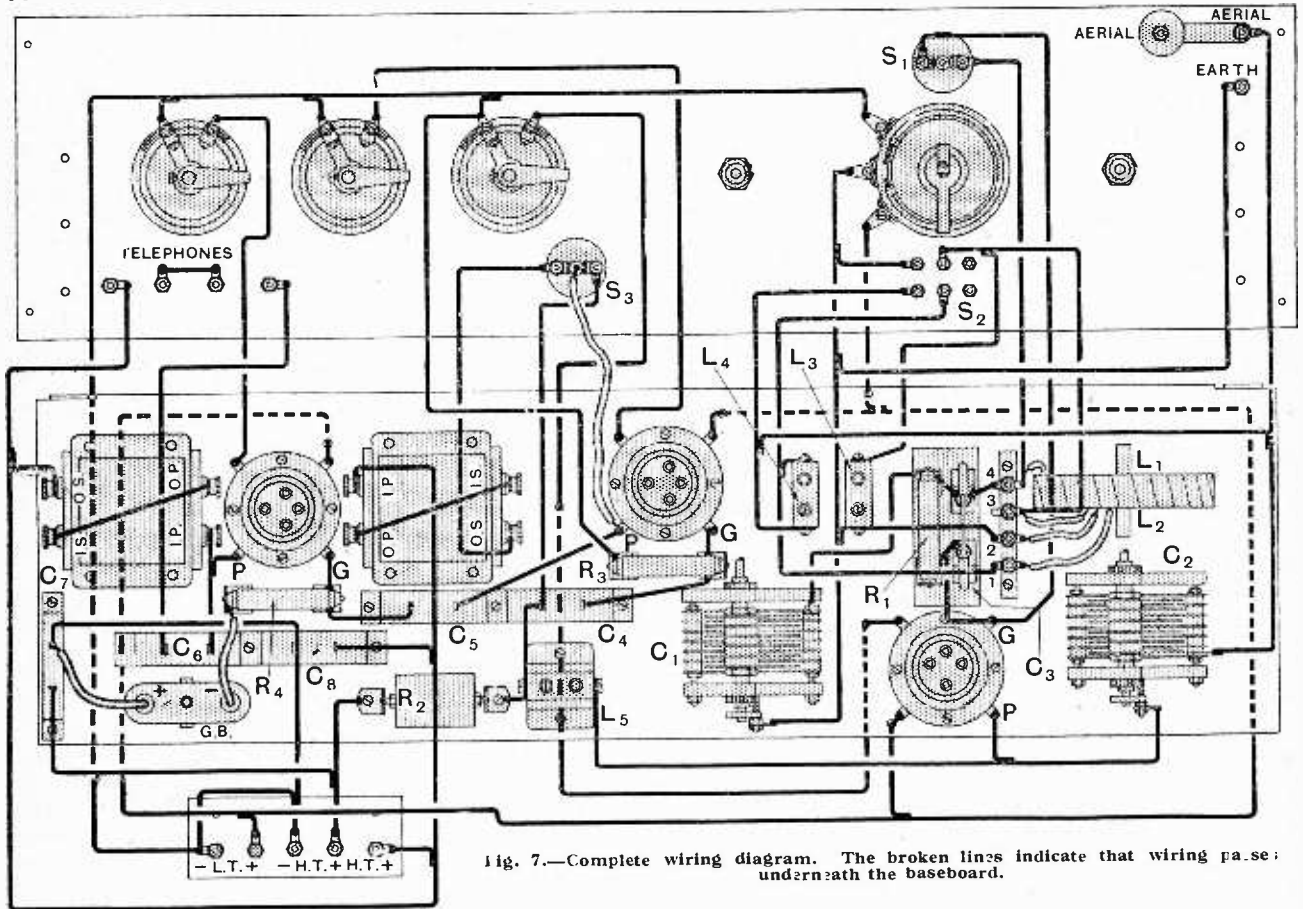

Fig. 7.—Complete wiring diagram. The broken lines indicate that wiring passes underneath the baseboard.

this direction will be amply repaid by the improved functioning of the set.

On the left of the baseboard, viewed from the front, we have the two variable condensers, the right-hand one being the tuning condenser, and the left the reaction condenser. A No. 4B.A. hole is drilled and tapped in the top and bottom plates of the condensers, which are held to the baseboard by countersunk screws passing through ebonite distance pieces to bring them to the required height with the spindles central on the panel. The spindles are lengthened with ebonite extension tubes and No. 2B.A. rod. If condensers of a different pattern are used, the method of mounting them is left to the constructor's own ingenuity.

again, are the two plug-in coils L_3 and L_4 , connected to the double-pole switch S_2 mounted on the panel below the potentiometer.

At the back of the baseboard is the H.F. choke coil L_5 and the anode resistance. This resistance may be made as follows. A length of 1in. ebonite rod $1\frac{1}{8}$ in. in diameter has six grooves cut into it $\frac{1}{8}$ in. wide and for a depth of $\frac{3}{4}$ in. A saw cut is made the whole length of the bobbin to the bottom of the grooves. Just over $\frac{1}{4}$ oz. of 47 S.S.C. Eureka wire must now be wound into the slots non-inductively.

To do this, wind 50 turns into the first groove, then carry the wire through the saw cut into the second one and wind on 50 more, then return to the first groove and

LIST OF COMPONENTS.

- 2 Variable condensers, 0.0005 mfd. (A.J.S.).
- 1 Accuratune dial.
- 2 Plug-in coils, Nos. 150 and 200.
- 1 Plug-in coil for choke, No. 500.
- 3 Coil holders for mounting on baseboard.
- 3 Valve holders (Sterling "Non-Pong").
- 1 Adaptor for D.E.Q. valve.
- 2 Filament rheostats, 25 ohms (King).
- 1 Filament rheostat, 6 ohms (King).
- 1 Potentiometer, 600 ohms (Ericsson).
- 1 Single-pole push-pull switch.
- 1 Double-pole push-pull switch.
- 1 Double-pole change-over switch.
- 1 Grid condenser, 0.0003 mfd. (McMichael).
- 1 Grid leak, 2 megohms (McMichael).
- 2 Grid leaks, 0.5 megohm (McMichael).

- 2 Mansbridge condensers, 0.5 mfd. (T.C.C.).
- 2 Mansbridge condensers, 1 mfd. (T.C.C.).
- 1 Mansbridge condenser 0.2 mfd. (T.C.C.).
- 2 Interval transformers (C.A.V., 1st stage).
- 12 Indicator terminals (Belling Lee).
- 1 Ebonite panel, 24in. x 6in. x 1/4in.
- 1 Wooden baseboard, 23 1/2in. x 6 1/2in. x 3/8in.
- 1 Terminal panel, 4in. x 1 1/2in. x 1/4in.
- 2 4in. angle brackets.
- 1 Cabinet (Carrington Manfg. Co.).
- 3 Coils of connecting wire (Glazite),
- 1/2-lb. No. 22 D.C.C. copper wire
- 1/2-oz. No. 47 S.S.C. Eureka wire.
- 1 Ebonite rod, 1in. dia., 2in. long.
- Ebonite tube, No. 2 B.A. screwed rod, soldering tags, etc.

wind the same amount in the opposite direction; this should be repeated until the two grooves are almost full, and repeated in the same way with the next two. When completed, the ends are soldered to tags screwed to the ends of the former, the whole being mounted between spring clips as shown.

The method of mounting the remainder of the components may be seen by a glance at Fig. 4.

The series aerial condenser is similar in construction to one recently described in this journal,¹ and consists of a washer of copper foil placed over the terminal screw and clamped by a 3/4in. diameter brass disc, being insulated from it by a further disc of mica 0.002in. thick. The aerial lead is joined to the copper foil.

The switch S₃, which is used to cut out the second valve, was converted from a single pole one, but a variety of the double-pole type can be purchased.

The grid biasing battery is held in place by a U-shaped brass clip screwed to the baseboard, and connections made to it by wander plugs on rubber flex.

It should be noted that some components are mounted directly on the baseboard, and although they are such that a slight leakage would be immaterial, it is best to be on the safe side and be certain the wood is free from moisture by baking well and then varnishing.

The brackets supporting the panel are mounted beneath the baseboard in order that sufficient clearance is given for some of the connecting wires to pass beneath it. These wires are shown dotted in the wiring diagram.

¹ *The Wireless World*, July 22, 1925, page 113.

The set having been completed, the coils and valves may be inserted, and the batteries connected up. The No. 200 plug-in coil is L₃, and is inserted in the left-hand socket, whilst the 150 coil L₄ goes in beside it, the No. 500 coil being used as the choke.

Testing.

Now join the aerial to the terminal so that the fixed condenser is in series with it and connect the earth and 'phones. Turn the reaction coil to zero and light up the valve, turning the potentiometer so that the grid is *minus* if anode rectification is used with the shorting switch closed, and *plus* if grid rectification is required with the switch open.

With regard to the rheostats, if the valves mentioned are used, then the detector should be just over half on, the D.E.3B. just on, and the D.E.4 almost fully on. Now tune in the local station.

This station having been successfully received, we may open the shorting switch S₂ and endeavour to receive the high-powered station. It may here be found that the set will not oscillate, and if after trying a larger coil in the right-hand socket, and a greater anode voltage still without results, the leads to the right-hand coil L₄ should be reversed.

When the set was finished it was tested ten miles north-west of London, and it was found that Cardiff and Bournemouth could both be received well on the headphones without interference from 2LO; whilst 2LO, 5XX, and Radiola was received quite successfully on the loud-speaker.

Streatham Radio Society.

The opening meeting of the new session of the above Society was held early this month, when Mr. Gerald Marcuse (G2NM) gave an interesting lecture. Mr. Marcuse dealt with his whole association with radio matters, and passed on to an interesting and amusing account of his visit to America last year.

Mr. Marcuse expressed the belief that many would be working on 20 metres soon as easily as they did now on the higher wavelengths.

Hon. secretary: N. J. H. Clarke, 26, Salford Road, S.W.2.

NEWS FROM
THE CLUBS.

North Middlesex Wireless Club.

A one-valve receiver constructed by Mr. H. A. Crowch was demonstrated by him at the last meeting of this club, on the 2nd inst., and even the owner was satisfied. Results were really remarkable.

After demonstrating the capabilities of his receiver Mr. Crowch gave particulars of its construction.

Hon. secretary: H. A. Green, 100, Pellatt Grove, Wood Green, N.22.

o o o o

Radio Society Presidential Address.

An ordinary meeting of the Radio Society of Great Britain will be held at the Institution of Electrical Engineers, Savoy Place, W.C.2, at 6 p.m. on Wednesday, September 23rd, when Sir Oliver Lodge, D.Sc., LL.D., F.R.S., the President, will deliver an address entitled "The Mechanism of Radiation."

VALVES WE HAVE TESTED

A 0.06 TYPE POWER VALVE.

The D.F.A.3 Mullard Valve.

THE use of a power amplifying valve in the last stage of a low-frequency amplifier operating a loud-speaker is to-day almost universal, and whilst the advantages to be gained by the use of such valves had long been recognised, it was not until the low-consumption filaments were introduced that they came within the reach of everyone. Power-amplifying valves can to-day be obtained which need a filament current of anything up to 0.8 amp. at voltages varying from 2 to 6, so that whatever the filament supply, a valve of the type under discussion can be found which will fit in without making any special arrangements.

The Mullard D.F.A.3, which we have recently tested, is of the 60-milliamperere variety, rated at 5.5 to 6 volts filament potential. It is interesting to note that the risk of overrunning the filament is negligible, since with a 6-volt accumulator the filament voltage cannot be exceeded by turning the filament resistance too far, as it can with a filament rated at 3 volts. In the particular sample on which we carried out our usual tests, the filament current was found to be rather above the rating, the actual figure being 0.1 ampere at 5.5 volts.

Filament Emission

The emission obtainable from these tiny filaments is really remarkable; 32 milliamperes was the figure we obtained, which represents an efficiency of 58 milliamperes per watt. This is a considerable advance since the day when power-amplifying valves used to consume as much as 1.5 amperes at 6 volts. On a circuit test and using the maximum recommended plate voltage (100 volts), the D.F.A.3 gave most satisfactory results in every way.

All 60-milliamperere valves have of necessity very fine filaments. Such valves must therefore be treated with reasonable care, and provided this is done, long reliable service will be given.

The appended table gives, in concise form, the results of our tests, and suitable combinations of plate and grid voltages, with the corresponding amount of plate current, are shown.

D.F.A. 3.

(Mullard Radio Valve Co., Ltd.)

Filament volts, 5.5. Emission (total) milliamperes, 32. Filament current, 0.1 amp. Efficiency, 58 milliamperes per watt.

Plate Volts.	Plate Current, Milliamps., at Zero Grid.	Grid Bias.	Plate Current Milliamps. ¹	Amplification Factor.	Plate Impedance. Ohms.
40	1.32	-1.5	0.8	6.8	23,000
60	2.7	-3.0	1.25	6.5	19,000
80	4.55	-4.5	1.85	6.3	13,500
100	6.9	-6.0	2.75	6.15	12,100

¹ Plate current when grid is biased to the value of Col. III

Two American Valves.

WE have recently received particulars of two new valves which have been developed by the Radio Corporation of America, the characteristics of which we give below.

To the British amateur these developments are interesting because it appears as though American practice will follow the British line of having a separate valve for each purpose.

There is one point in connection with these new valves which might be copied with advantage by our own manufacturers, and that is the very complete information as to the operating data which accompanies the valve. Actually this information is practically identical with that which we provide when giving reports on valves we test—that is, the amplification factor and the plate impedance are given at a suitable working point which is indicated by the plate and grid voltages in the table, and not at a point which makes the valve appear better than it really is.

Radiotron UX112.

This valve has an oxide-coated filament consuming 0.5 amp. at 5 volts, and is primarily intended for L.F. amplification, but will, however, give good results as a detector when suitably adjusted. For the latter purposes the plate potential should be not more than 40 volts. Used in conjunction with a grid condenser and leak, the grid return must be connected to the positive end of the filament.

RADIOTRON UX 112.

Plate Volts.	Normal Grid Bias.	Plate Current, Milliamps. ¹	Amplification Factor.	Plate Impedance. Ohms.
90.0	- 6.0	2.4	7.9	8,800
112.5	- 7.5	2.5	7.9	8,400
135.0	- 9.0	5.8	7.9	5,500
157.5	-10.5	7.9	8.0	4,800

¹ Plate current when grid is biased to the value of Col. II.

Radiotron UX210.

The UX210 is designed primarily as a power amplifier for a large, distortionless output, and has characteristics similar to the L.S.5 valve. Its normal filament rating is 1.1 amp. at 6 volts, but may be run up to a maximum of 1.25 amps. when a very large output is required. Plate voltages up to a maximum of 425 may be used.

RADIOTRON UX 210.

Plate Volts.	Normal Grid Bias.	Plate Current, Milliamps. ¹	Amplification Factor.	Plate Impedance. Ohms.
90.0	- 4.5	3.0	7.5	9,700
112.5	- 7.5	3.0	7.5	9,700
135.0	- 9.0	4.5	7.5	8,000
157.5	-10.5	6.0	7.5	7,400
250.0	-18.0	12.0	7.5	5,600
350.0	-27.0	18.0	7.65	5,100
425.0	-35.0	22.0	7.75	5,000

¹ Plate current when grid is biased to the value of Col. II.

CRYSTAL DETECTORS.

The Electrical Properties of Contact Rectifiers.

By F. M. COLEBROOK, B.Sc., D.I.C., A.C.G.I.

(Continued from page 296 of the Sept. 2nd issue.)

IN the first place we must enquire exactly what is meant by the high-frequency resistance of a crystal detector, for the latter is not an ordinary conductor in relation to which the term has an obvious significance.

For any given conditions of signal amplitude and d.c. load the alternating current in the detector circuit will have a definite component of fundamental frequency, together with several other currents whose frequencies are multiples of the fundamental or supply frequency. (Readers who are familiar with Fourier's Theorem will have no difficulty in appreciating this.) It can be shown, however, that of all these high-frequency components of current, only that of fundamental frequency will absorb any power from the source, since that is the only one of the same frequency as the supply e.m.f. If, therefore, we write I for the amplitude of this fundamental frequency current, the high-frequency resistance of the detector, R_1 , can be defined by the ordinary relation

$$I_1 = \frac{E}{R_1}$$

and the high-frequency power consumed by the detector will then be, as with any ordinary resistive conductor,

$$P_1 = I_1 E / 2 = I_1^2 R_1 / 2.$$

These simple relationships will be exactly true in the

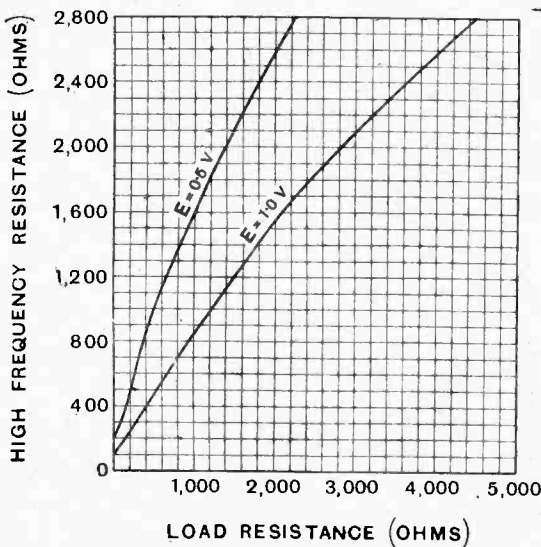

Fig. 14.—Curves of high-frequency resistance in terms of load resistance obtained by calculation.

In the first part of this important series of articles dealing with the practical results of a long investigation into the behaviour of crystal detectors, the writer dealt with the fundamental principles of continuous wave rectification. He discussed the effect of the internal resistance of the crystal and the effect of a direct current load. In this, the second part of the series, the subjects under discussion are the High-frequency side of the Rectification Process, and the crystal as an energy transformer.

ideal case we are considering, *i.e.*, with a maintained high-frequency, e.m.f. of negligible internal resistance, and with no appreciable fall of high-frequency voltage in the load. Under conditions of actual reception they will not be strictly true, since the finite resistances of the coils or other parts of the circuit will cause a certain amount of power loss to be associated with high-frequency components other than the fundamental. The above expressions are, nevertheless, the most satisfactory way of

defining the high-frequency resistance of the detector, it being understood that $I_1^2 R_1 / 2$ represents the minimum high-frequency power consumption under efficient conditions of reception.

It is obvious that R_1 will vary with E . Further, it was shown in the preceding section that it will depend

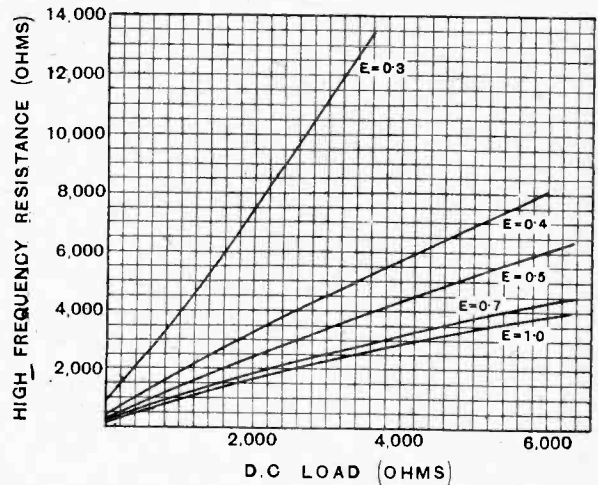

Fig. 15.—High-frequency resistance of galena detector for large amplitudes.

very greatly on R , the d.c. load. What is required, therefore, is a knowledge of the magnitude and variation of R_1 with E and with R for representative detectors.

The direct measurement of this quantity is a matter of considerable difficulty. A method, which certainly seems to meet the requirements of the problem, has been described in *Experimental Wireless* of January, 1925. Up to the present date the writer has not made any direct measurements of R_1 , but has obtained values for this quantity by the somewhat laborious method of deducing from the rectification performance of a detector the form of its current-voltage characteristic under the conditions

Crystal Detectors—

of operation and then determining the magnitude of I_1 under specified conditions by the graphical analysis of the alternating current wave form. For instance, the curves of Fig. 14 illustrate the results for a typical specimen of galena.

For a characteristic of the kind shown in Fig. 3¹ the value of R_1 under any given conditions of load and signal amplitude can easily be calculated. The curves of Fig. 15 were obtained in this way for a characteristic

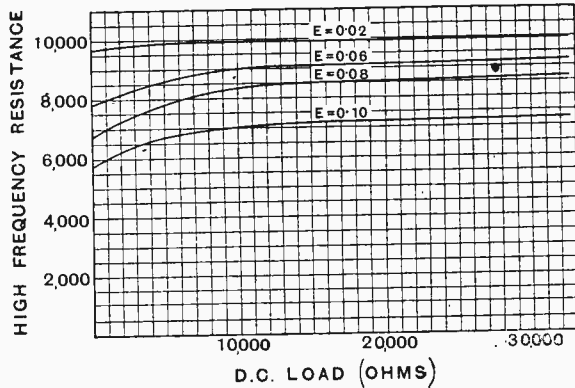

Fig. 15a.—High-frequency resistance of galena detector for small amplitudes.

which can be considered to represent very approximately the behaviour of a galena detector at large amplitudes. It will be seen that R_1 increases as E decreases, and increases as R increases.

H.F. Resistance for Small Amplitudes.

For small signal amplitudes the value of R_1 can also be obtained by calculation, and typical results for galena are shown in the curves of Fig. 15a. In general it can be said that for small signal amplitudes R_1 will be very much greater than for large signal amplitudes, and will vary less with E and with R .

For a perikon detector the corresponding values will be greater than those for galena. The following table will give some idea of the comparison between them.

GALENA.					
E	$R =$	0	1,000	4,000	10,000
1	$R_1 =$	100	800	3,000	—
0.5		200	1,300	4,300	—
0.1		5,700	6,000	6,700	7,000

PERIKON.					
E	$R =$	0	1,000	4,000	10,000
1	$R_1 =$	500	1,500	3,000	8,500
0.5		1,000	3,000	7,000	—
0.1		15,000	15,000	15,000	15,000

Individual specimens will of course show considerable variation among themselves in the value of R_1 , and the figures quoted can only be considered as showing the order of the magnitude of R_1 and the general character of its variation with the conditions of operation.

Having now considered separately the direct current and the high-frequency sides of the rectification process, we are in a position to discuss the operation of a detector as a transformer of high-frequency power into continuous current power and to consider the circuit conditions appropriate to its practical applications.

Continuous Wave Rectification. Energy Conditions.

It has been shown that under any conditions of signal amplitude and of d.c. load the rectified current given by the detector can be expressed in the form,

$$i_c = \frac{E_c}{R + R_c}$$

E_c being an effective rectified e.m.f. and R_c an effective internal resistance. It is well known that if the e.m.f. and the internal resistance were constant with respect to R , then the best value for R , i.e., the load which would give the maximum continuous current power, is $R = R_c$. Actually both E_c and R_c depend to some extent on R , so the relationship is not quite so simple as this. However, for a given constant signal amplitude there will always be a certain load resistance which will give the maximum continuous current power, and in general this optimum resistance will not differ very greatly from the value of R_c at no load. For instance, curve *a* of Fig. 16 shows the measured variation of the continuous current power

$$P_c = i_c^2 R$$

with R for a galena detector. There is a very sharp maximum corresponding to a load of about 100 ohms. For a perikon detector working under similar conditions of fairly large signal amplitude the optimum load will probably be from 300 to 600 ohms. For small signal amplitudes the optimum load increases very rapidly, in much the same way that R_c increases. For galena it will vary from about 10,000 to 20,000 ohms for signal amplitudes less than 0.1 volt.

The above discussion would appear to indicate that for fairly large signal amplitudes apparatus of fairly low resistance should be used in conjunction with crystal detectors. It must be remembered, however, that the conditions assumed above are not those of actual reception. In the first place we are considering the rectification of a pure continuous wave, not heterodyned and not modulated. Further, it has been assumed that the input e.m.f. is constant, i.e., is independent of the load imposed on the

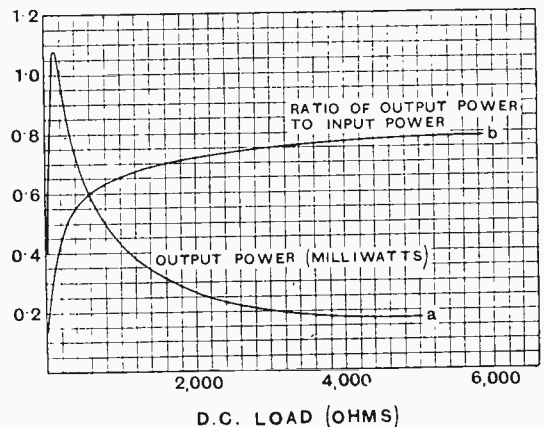

Fig. 16.—Galena detector with signal e.m.f. of 1 volt (amplitude).

¹ The Wireless World, September 2nd issue, page 294.

Crystal Detectors—

e.m.f. by the detector. In practice the signal amplitude will depend very greatly on the high-frequency power taken from it. This point will be considered more fully later on. For the present it will be sufficient to point out that in the application of a detector to direct reception of wireless signals the best circuit conditions will be, not those which give the maximum continuous current power on the assumption of a constant input e.m.f., but those which correspond to the maximum efficiency of transformation of high-frequency power into continuous current power. It will therefore be necessary to see how this efficiency of transformation, i.e., P_c/P_1 , varies with the load resistance.

Curve *b* of Fig. 16 illustrates the variation with *R*, the d.c. load, of the transformation efficiency for a galena detector at a constant signal amplitude of 1 volt. The data for this curve were obtained partly by measurement and partly by calculation in the manner described above. The difference between the two curves of Fig. 16 is very marked, and serves to emphasise the point that the best load resistance for use with a crystal detector will not necessarily be that appropriate to its effective internal resistance. This is further confirmed by the curves of Fig. 17, which show the variation of P_c with *R* for a galena detector operating under conditions of constant input energy. This condition means that $E^2/2R_1$ is constant, and as R_1 increases with *R*, *E* will also increase with *R* in the manner shown on the curves. The data for these curves were obtained by calculation with a characteristic of the type shown in Fig. 3, the constants of the characteristic being chosen so as to make it an approximate representation of a galena detector.

The most striking feature of these curves is the very high efficiency of transformation recorded by them for the higher resistance loads. These efficiencies of 80 per cent. and 90 per cent. were very much higher than the writer had anticipated, and caused him to examine very carefully the calculations and the analysis involved in their determination. However, efficiencies of this order

have since been confirmed by direct measurement by the method previously referred to.

As far as moderately large signal amplitudes are concerned, it is clear that apparatus of fairly high resistance will give the best efficiency of transformation, and therefore the largest continuous current-power output for a given energy input.

At fairly small signal amplitudes the variation of high-frequency resistance with d.c. load is very much less, and for any given signal amplitude the input power will not vary greatly with the d.c. load. However, the most suit-

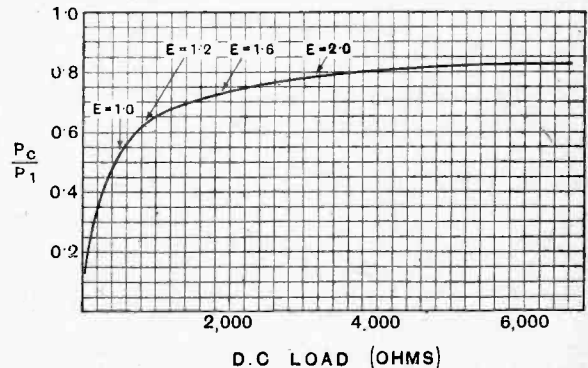

Fig. 17.—Variation of output power with D.C. load for a given constant input power (1 milliwatt).

able load resistance will be large in this case also, for the effective internal resistance of the detector will be large—of the order of tens of thousands of ohms.

The reader is reminded that the whole of the above conclusions refer to the conversion of continuous high-frequency e.m.f.'s into direct current. A more usual application of a crystal detector is the conversion of a modulated high-frequency e.m.f. into audible frequency power. It will now be well to consider the latter case and to see how it resembles or differs from the former.

(To be continued.)

TRADE NOTES.

British-made American Valves.

The Cleartron Radio Tube, a well-known American receiving valve, is now manufactured in this country by Cleartron Radio, Ltd., whose offices are at 1, Charing Cross, London, S.W., their British works being situated at Birmingham. Cleartron valves cover a range to suit all purposes.

New R.I. Representative.

Messrs. Radio Instruments, Limited, inform us that they have appointed Mr. H. Patrick, of 246a, Corporation Street, Birmingham, as their representative for Birmingham and the Midland Counties.

An Interesting Move.

Messrs. Leslie Dixon & Co. advise us that they are shortly moving to larger and more commodious premises at 218, Upper Thames Street, London, E.C.4. where it will be possible to make a more comprehensive display of electrical and radio apparatus for the benefit of customers.

Gecophone Grip Terminals.

The series of Gecophone grip terminal connectors, manufactured by the General Electric Co., Ltd., has been added to on account of the success of the original spade and pin types.

They are now available in four forms, the two new additions being a series connector and a wander plug.

Growth of Bristol Wireless Business.

Since the formation of the limited company in 1923, the wireless business of Messrs. Automobile Accessories (Bristol), Ltd., has increased to such an extent that it has been found necessary to open two new service depots. These are situated at 15, High Street, Exeter, and 42, High Street, Poole.

G.E.C. Superheterodyne Receiver.

In the pages devoted to the description of the stands of the Exhibition at the Albert Hall, reference was made on page 318 to the supersonic heterodyne receiver of the General Electric Co., Ltd. This instrument should have been described as a Gecophone Receiver.

"Therla" Condensers.

All "Therla" condensers bearing a blue label have been examined by the Faraday House Testing Laboratories and are guaranteed to be within 10 per cent. of the stated capacity. "Therla" grid leaks are also similarly tested and are correct to within 5 per cent.

Wet Cell H.T. Battery.

Ripaults, Ltd., King's Road, St. Pancras, London, N.W.1, have recently issued a pamphlet describing a new type of Leclanché wet cell suitable for high tension supply. Many months' service can be obtained from a battery of these cells, which can be easily recharged when necessary.



A Review of the Latest Products of the Manufacturers.

SHORT WAVE COIL.

Messrs. N. V. Webber and Co., Vale Road, Outlands Park, Weybridge, are specialising in the manufacture of components for experimental work and in particular transmitting and receiving equipment for use on short wavelengths. A Webber coilholder for short wave reception was recently shown in these pages and now a new type of coil has been developed with widely spaced pin connectors for use in the holder.

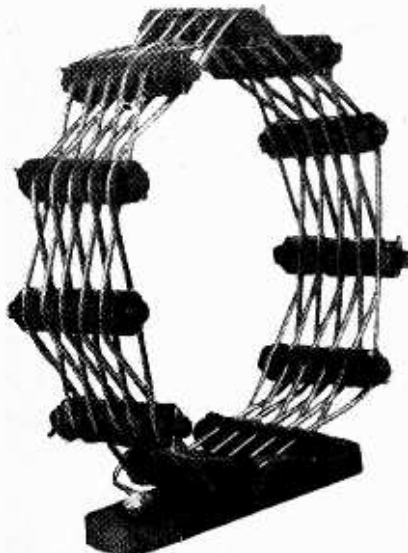

The Webber short wave tuning coil. It is about 5in. in diameter.

No. 16 S.W.G. copper wire is used and the cross supports are of ebonite rod with ebonite spacing pieces. The method of winding is unusual, though undoubtedly efficient and robust.

o o o o

MAGNUM NEUTRODYNE CONDENSER.

This condenser is of the type in which the capacity depends upon the distance between two flat discs, one of which is mounted on an adjusting screw. A long threaded bush is provided which is split to maintain an even pressure on the screw and eliminate "back-lash."

The condenser is totally enclosed in a well-finished ebonite case which is held

together by three long screws. The zero capacity introduced by the screws should not be overlooked when balancing receivers which require only a small neutralising capacity.

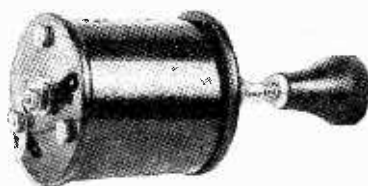

An enclosed type neutrodyne condenser.

The manufacturers are Messrs. Burne-Jones & Co., Ltd., 296, Borough High Street, London, S.E.1.

o o o o

BALL-BEARING VARIABLE CONDENSER.

An unusual appearance is produced by the use of the shovel shaped moving plates adopted in the construction of the variable condenser made by Messrs. S. A. Lamplugh, Ltd., King's Road, Tyseley, Birmingham. In the latest model the plates are of brass, finished bright, and pressed on the face with a rectangular pattern so that perfect flatness will be retained. The fixed plates, as can be seen in the accompanying illustration, are carried on two rods secured to two ebonite



The Lamplugh condenser is fitted with ball bearings and the plates are of somewhat unusual design. The fibre cover to be seen on the metal end-plate protects the bronze spiral, which connects to the moving plates.

cross pieces and to which are attached the metal end plates for supporting the bearings. The spindle of the condenser is held in position by means of ball races fitted at each end, a novel feature which avoids the use of spring washers or large friction surfaces. The moving plates are held firmly in place and without end play, though a fairly hard adjustment on the races is necessary. Distribution of the electrostatic strain across the insulating supports is probably good and a very low minimum capacity is obtained. Reliable contact is made with the moving plates through a coil of bronze strip. One hole fixing is employed with a large brass bush and a standard Lamplugh dial if fitted.

o o o o

EDISWAN TUNING COILS.

Compactness is a feature of the Ediswan plug-in tuning coils. Though the turns of wire composing the coils are

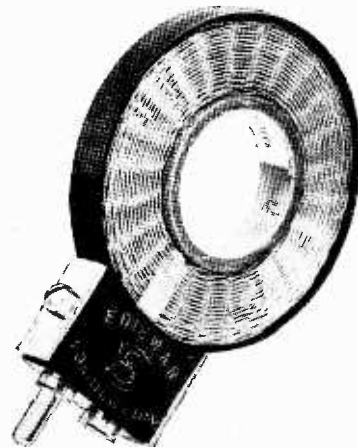

Ediswan tuning coil with an optimum wavelength of 1,600 metres.

exposed the construction is quite robust, the wire being apparently lightly impregnated and baked hard. A honeycomb form of winding with spacing between turns of about three times the wire diameter is employed. A tight fibre band securely attaches the coil to the socket and the ends of the winding are clamped under metal plates with screws passing through into the plug and socket connector.



Brain Waves of the Wireless Engineer.

A Parallel Movement Condenser.
(No. 233,163.)

A rather interesting type of condenser is described by E. T. Cook in British Patent No. 233,163. The idea of the invention will be readily appreciated by

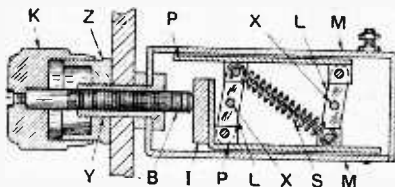

Compact variable condenser with micrometer adjustment. (No. 233,163.)

reference to the accompanying illustration, which shows one form of the invention. It will be seen that one element of the condenser consists of a rectangular metal box M, while the other element of the condenser consists of two flat plates P. These are connected together by links L, which work on pins X, and a spring S normally tends to bring the plates together. One end of one of the plates P is bent at right angles, and is provided with an insulating block I. The end of the metal case is attached to the panel by means of the usual "one-hole fixing" nuts, and a bush Y serves to hold the device. A screw B works through this bush, and is provided with a knob K. It will be seen that on rotating the knob the screw will advance and the end will bear on the insulating block I. This will cause the links L to pivot about the pins X, and opposing the force of the spring, will cause the movable plates P to approach the fixed plates, or metal sides of the case. It will be noticed that a scale can be arranged by measuring off the distance which the knob advances along the surface Z in a manner similar to that employed on a micrometer.

o o o o

A High-frequency Amplifier.
(No. 233,053.)

A system of high-frequency amplification is described by W. Rawsthorne in the above British Patent. The invention describes both the method of constructing special transformers, and also the manner of connecting them, which is indicated by the accompanying diagram. The inventor states that he claims the construction of a transformer in which the secondary is

tuned, and the primary is untuned, and of such a size as to prevent sufficient voltage being produced across it to cause oscillation of the circuit through the inter-electrode capacities of the valves. The transformers, which are used both in the aerial circuit and intermediate circuits, consist of two coils L_1 and L_2 . The windings L_2 are tuned by variable condensers C_1 to the desired frequency, while the primary windings L_1 are left untuned. It is stated that these transformers may be made by arranging two sets of windings on a cylindrical former leaving a small space between them, or arranging two concentric basket coils or slab coils. The end turns of the two windings which are nearest together are connected to the earthed side of the system. Thus in the accompanying illustration X and Y show

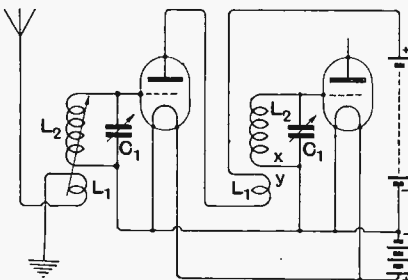

High-frequency transformer couplings with small resistance wound primaries to prevent self-oscillation. (No. 233,053.)

the coils in true relation to each other, the proximate turns being respectively connected to the filament and the earth. The arrangement of the coils L_1 , L_2 simply constitutes an ordinary step-up transformer, and systems of this description must obey the ordinary transformer laws, and to us appears to be little different from an ordinary step-up transformer the primary of which happens to be untuned.

o o o o

Filament Construction.
(No. 233,375.)

A valve filament of interesting and rather novel construction is described in the above British Patent, granted to W. R. Bullimore. The filament, it is explained, has a comparatively large diameter in proportion to its resistance, whereby the important advantages of greater mechanical strength and emissive surface are obtained without increase of filament temperature

or heating current consumption. A further feature of the invention is the provision of an active emissive coating which will remain united to the filament.

The invention really consists in coating a core of refractory metal or alloy, of relatively high specific resistance and melting point, with one of the "noble metals," i.e., one which does not tarnish under ordinary conditions. The filament may be produced, for example, with a core of nickel-chrome alloy with a deposited coating of platinum, or alternatively a molybdenum or tungsten wire may be coated with platinum or palladium. For example, platinum may be deposited by passing the core through a bath of ammonium platino-chloride salt.

The alkali metals and the metals of the alkaline earths are particularly active in giving off electrons under the influence of heat, and the specification states in detail how filaments may be coated by immersion in the nitrates of these elements.

o o o o

A Simple Lead-in.
(No. 233,447.)

A simple and effective lead-in device is described in the above British Patent by A. G. London. The ordinary ebonite or similar insulating tube is provided on either side with a fixing nut F. The lead consists of a rod R which passes through the tube and is provided with two terminals T_1 and T_2 . The terminal T_2 is inside the house, and goes to the aerial terminal of the set, while the terminal T_1 is connected to the end of the aerial. The

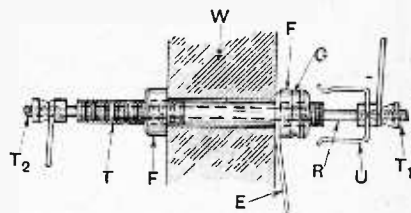

Combined lead-in tube and earthing switch. (No. 233,447.)

metal fixing nut F which is external to the house is connected to the earth, and is provided with a peripheral groove G. The terminal T_1 has fixed to it a U-shaped spring so arranged that when the rod R is pulled through the tube the spring makes contact with the nut F, thereby earthing the aerial.

B 41

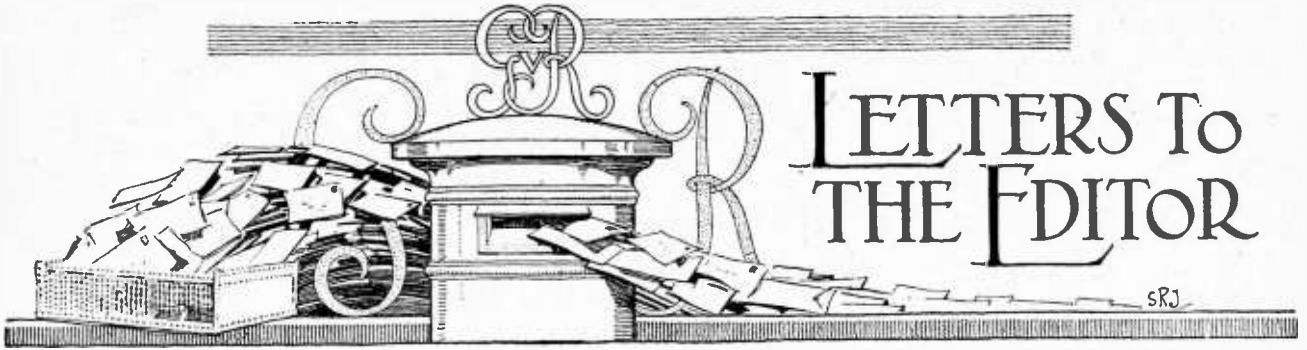

The Editor does not hold himself responsible for the opinions of his correspondents.

Correspondence should be addressed to the Editor, "The Wireless World," 139-140, Fleet Street, E.C.4, and must be accompanied by the writer's name and address.

UPERSONIC VERSUS NEUTRODYNE.

Sir,—To take up Mr. Willans' letter point by point would need an equal space or possibly more.

I would be the first to admit that the superheterodyne is a very powerful method, and I am only in the position of comparing two very powerful methods and stating my own preferences.

Both methods deliver the goods in more or less good condition, and if either method did not exist the other would be supreme.

But I must still maintain that cross breeding the superheterodyne with a high-frequency filter strengthens it, and I will take up the one point Mr. Willans classifies under heading (1).

In my article * I say :—" The beat tone frequency of the usual supersonic receiver is about 50,000, and this is dictated by experience. At this frequency the centres of the two wavelength bands, which will enter the filter unless otherwise prevented, are 100,000 frequency apart. To design the set that only one band can be received, we must precede the beat tone filter by a H.F. filter which will reduce a near-by wave with 100,000 cycles difference to 1/1000. This cannot be done by one H.F. circuit without sharpening its tuning too much, and two tuned H.F. circuits are therefore necessary. Unless one is prepared to dodge from one position of the heterodyne to the other, hoping for luck."

This statement of mine, although correct, is possibly difficult to read, and I think Mr. Willans has probably misunderstood it. A little further explanation may be useful.

By one H.F. circuit I mean the tuned frame; by two H.F. circuits, a tuned frame and either a coupled circuit or a tuned anode circuit.

In Fig 6 of my article I have carried the idea to three filter circuits.

Both calculation and test since reading Mr. Willans' letter show that :—

- (1) One H.F. filter alone as usually used—that is with the frame connected to the rectifier, and oscillations provided either by self or independent oscillator—leaves both positions of the heterodyne open to attack from strong, but not necessarily local, stations.
- (2) Two H.F. filters leave only one position open to attack, and that only from a near-by station.
- (3) Three H.F. filters will leave both sides clean except in very exceptional circumstances.

Instead of considering the reduction of a near-by station to 1/1000 let us look at it in another way. Referring to Fig. A,

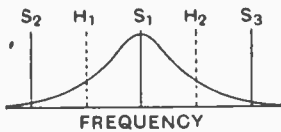

FIG. A.

to H1, and the beat tone tuning, of course, is to the right

* Selectivity, by H. J. Round. See *The Wireless World*, August 12th, 1925, p. 195.

frequency, S₂ will come in 1/xth of S₁. Similarly, if we heterodyne to H₂, S₃ comes in. In my article I assumed that if we have two equal signals, one of these must be reduced to 1/15th to leave the other pleasant to listen to. This condition can be met by a H.F. resonance curve like my Fig. 1, where 100,000 cycles difference gives a reduction to 1-40th.

But three considerations here enter. Firstly, a reduction to 1/15th may hardly be enough in certain cases. (For instance, chamber music with a background of jazz hand.)

Secondly, that S₁ may easily be much weaker than S₂ and S₃ in actual practice; and, thirdly, the curve of Fig. 1 is sharper

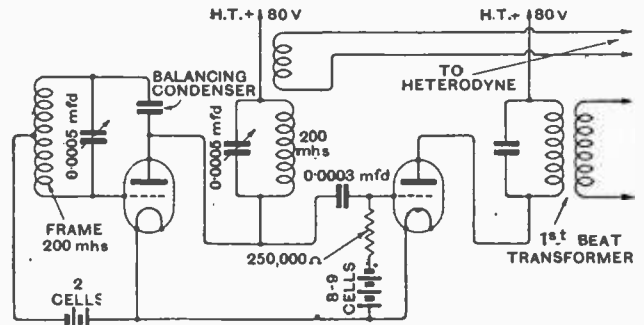

Fig. L.

than we could permit for good quality, considering that it has to be multiplied by the beat tone filter.. In fact, the 1-40th in practice would probably be 1-15th, due to the first and third points alone—a very bare margin to take care of weak signals from S₁.

But multiply it by another resonance curve in which the reduction is to only 1-5th say—a very flat resonance—and the 1-15th becomes 1-75th, which would be enough in most cases.

We certainly introduce three handles, but the tuned anode can be made so flat that it will easily link mechanically with the frame tuning over the whole range.

Incidentally this circuit helps in the removal of the long wave trouble, without special aerials, amongst other advantages. A practical realisation of these principles is shown in the circuit in Fig. B. H. J. ROUND.

TELEPHONY FROM THE ARCTIC.

Sir,—I was listening in to WAP working with F8FW, and during the course of the messages he mentioned that they would be broadcasting voice and music at 11 p.m. on September 10th. So I stood by, and I am pleased to inform you that both speech and music were received here quite O.K. on the loud-speaker! But the ripple was very troublesome and the quality of the telephony was not very good. Nevertheless, it was from the polar regions, and I suppose it is the first time that this has been done in the history of wireless. R. E. WILLIAMS. Holyhead.

Readers Problems

Readers Desiring to Consult "The Wireless World" Information Dept. should make use of the Coupon to be found in the Advertisement Pages.

Long Distance with Two Valves.

THE question of what is the utmost that can be done with two valves frequently arises in the minds of readers who, owing to lack of accumulator charging facilities or otherwise, have decided to limit their wireless activities to this number of valves. If volume from the local station, or from a station at a moderate distance, is the main requisite, then a regenerative detector with a stage of L.F., or a two-valve and crystal reflex receiver, will meet the case, but if, as is often the case, the utmost range with telephones is the main desire, it is necessary to construct a receiver having one stage of high-frequency amplification in addition to reaction. The question then arises as to what is the most efficient form of H.F. coupling. Now it may be truthfully said that the efficiency or otherwise of an H.F. stage depends less on the particular H.F. circuit used than it does on paying careful attention to avoiding losses. It is essential to use an efficient system of disposing the components on the panel and baseboard, so that all leads which are at a high potential with respect to H.F. currents are short and direct as possible, in order to avoid losses due to strong capacitive effects, etc. At the same time it is as well to use as efficient a circuit as possible, and it will usually be found that if a method is employed of neutralising the stray capacities due to the valve and its associated wiring, superior results will be obtainable from the point of view of ease of handling and distance getting than if the ordinary

tuned anode or H.F. transformer were employed.

Unfortunately the average set builder is averse to the neutrodyne, since he imagines that it is an instrument necessitating more than one H.F. stage and irrevocably bound up with the rather cumbersome tilted H.F. transformer. If a little care is exercised, however, a very efficient neutrodyne receiver can be constructed, in which basket coils are employed throughout, and which can also be adapted for the 1,600 metre wavelength. The connections are very simple, as will be seen from our diagram below. The neutrodyne transformer for the ordinary B.B.C. band of wavelengths can be constructed by first winding 24 turns of No. 24 D.C.C. in the form of a basket coil; this will form the primary of the H.F. transformer, the secondary containing 66 turns of a similar gauge. Both primary and secondary should be wound in the same direction on a former 1½ inch in diameter and having 13 spokes. The beginning of the secondary should be connected to the grid condenser of the detector valve, and the end of the primary should go to the anode of the H.F. valve. The tap for the neutralising condenser should be made at the centre of the secondary winding. For the Daventry wavelength 100 turns on the primary and 250 turns on the secondary is correct, but in order to obviate having a secondary of excessive diameter as compared with the primary it is best to wind two basket coils of 125 turns each and place them side by side with one end of each half electrically connected to the other. The primary winding can now be mounted between the two halves of the secondary with suitable insulation, whilst the neutralising tap should be taken at the junction between the two halves of the secondary. The aerial and reaction coils should be of usual sizes appropriate to the wave-lengths being dealt with.

Alternative Methods of Connecting a Loud-speaker.

A READER wishes to use an arrangement of three jacks in the anode circuit of the last valve of his receiver, so that he can employ his telephones or loud-speaker either directly in the anode circuit of the valve, or through the choke feed method or a 1:1 ratio output transformer as desired to prevent the steady H.T. current passing through the windings.

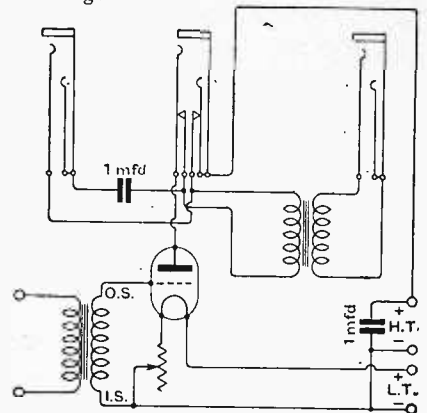

Fig. 2.—Telephone jacks arranged to give "choke-feed," transformer or direct coupling with the last valve of an amplifier.

This is quite simply accomplished, as will be seen by referring to our diagram in Fig. 2, and the connections are quite straightforward. It is necessary to obtain an output transformer of 1:1 ratio if a loud-speaker of 2,000 or 4,000 ohms is to be used. These instruments can, of course, be obtained from many advertisers in this journal. Should it be desired to use a 120 ohm loud-speaker, a transformer having a ratio of 10 to 1 is required. No choke need be purchased, since the primary of the transformer can be made to serve this purpose, as will be seen by referring to the diagram. There is no need to employ a coupling condenser larger than the value given in our diagram, since this capacity amply suffices to pass even the lowest musical frequencies.

o o o o

Problems of Selectivity.

A NUMBER of readers who have attempted to construct neutrodyne sets having two or three H.F. stages, or have added a loose-coupled

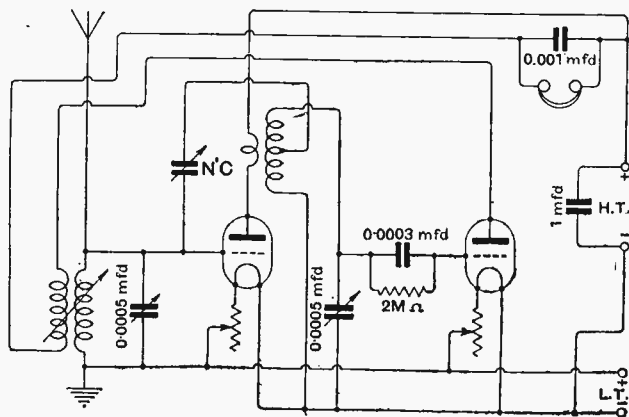

Fig. 1.—Two-valve neutrodyne receiver.

tuner to their existing receivers in order to attain a sufficient margin of selectivity to receive distant stations whilst the local station is "on the air," have found that in spite of all their efforts the local station still comes through with sufficient strength to mar reception from more distant stations. At first this might appear rather puzzling, since the receivers are usually very sharp in the tuning; so much so, in fact, that a wavemeter is desirable in order to pick up stations at even moderate distances.

This complaint has been persistently received from readers living within two miles or so of their local station, and the cause of the trouble is not very difficult to locate. Owing to the nearness of the local stations it is found that the tuning coils or H.F. transformers associated with the detector valve or the various H.F. valves are acting as small frame aeri-als, thereby picking up energy on their own account. Obviously no amount of loose-coupling in the aerial circuit or other devices for attaining selectivity will counteract this evil, and some further remedy must be sought. It is quite clear that the only feasible method which can be adopted is to completely screen the tuning coils so that strong local signals cannot cause interference in this manner. One method is to screen each coil individually, and this method possesses the additional advantage of eliminating any stray magnetic coupling that may exist between the various coils and H.F. transformers to the detriment of stability. On the other hand, this method is apt to produce very appreciable damping in the circuits in question, and it is usually more efficient to completely line the inside of the cabinet with copper foil. Readers living further out from a local station do not experience this difficulty, and at ten miles out it is quite a simple matter to build a receiver possessing sufficient selectivity combined with stability to eliminate completely the local station. When a frame aerial is used it is interesting to note that forced oscillations may be set up by long-wave stations. This effect was described on page 376 of the previous issue.

BOOKS FOR THE WIRELESS EXPERIMENTER

Issued in conjunction with "The Wireless World."

"THE AMATEUR'S BOOK OF WIRELESS CIRCUITS," by F. H. HAYNES. Price 3/6 net. By Post, 4/-.

"TUNING COILS AND METHODS OF TUNING," by W. JAMES. Price 2/6 net. By Post, 2/10.

"WIRELESS VALVE RECEIVERS AND CIRCUITS IN PRINCIPLE AND PRACTICE," by R. D. BANGAY and N. ASHBRIDGE, B.Sc. Price 2/6 net. By Post, 2/10.

"WIRELESS VALVE TRANSMITTERS—THE DESIGN AND OPERATION OF SMALL POWER APPARATUS," by W. JAMES. Price 9/- net. By Post, 9/6.

"DIRECTION AND POSITION FINDING IN WIRELESS," by R. KEEN, B.Eng. Price 9/- net. By Post, 9/6.

"THE RADIO EXPERIMENTER'S HANDBOOK," Parts 1 & 2, by P. R. COURSEY, B.Sc. Price 3/6 net. By Post, 3/10.

Obtainable by post (remittance with order) from **ILIFFE & SONS LIMITED, Dorset House, Tudor St., London, E.C.4.,** or of Booksellers and Bookstalls

Two-valve Reflex Receiver.

A READER is desirous of building a two-valve reflex receiver in which the parallel system of feed back is employed, as distinct from the more usual type of feed back which has been published from time to time in these columns.

We illustrate in Fig. 3 a suitable circuit employing this principle. This is a very useful circuit, which has not achieved the popularity among reflex devotees to which it is entitled. The difficulty with the usual type of reflex receiver is its tendency to burst into low-frequency "buzzing." Usually, if reaction is employed, the receiver commences to oscillate at an audible frequency with a very slight degree of reaction coupling, with the result that very little useful benefit is obtainable from reaction. The use of the system illustrated in our circuit overcomes this disadvantage to a large extent. It is important that really efficient H.F. chokes be used which have low self-capacity. These may be obtained

from advertisers in this journal. The condensers shunting various high-impedance portions of the circuit are important. In general the circuit will be found more efficient for long-distance work than the more usually adopted form of dual circuit.

Correct Resistance Value of Telephones.

A CORRESPONDENT who is building a two-valve receiver which is designed for obtaining maximum signal strength on headphones is contemplating the purchase of a pair of 8,000 ohm telephones in order to obtain maximum efficiency.

It is most certainly advised that our reader should make no attempt to employ 8,000 ohm receivers in conjunction with a valve receiver, unless an output transformer or some alternative method of keeping the steady H.T. current from traversing the phone windings is employed, since it will be found that the wire used in these very high-resistance telephones is so fine that a serious risk of breakdown is incurred. Usually these telephones are only intended to be used in conjunction with a crystal receiver. Even though it may be possible to obtain a sufficiently robust pair of 8,000 ohm telephones, it is not recommended that such a high resistance be employed for best results. Usually, of course, telephones are used after a moderately high impedance valve, and the customary 4,000 ohm telephones have usually a sufficient impedance for the purpose, but under ordinary conditions no advantage will be obtained by using a higher resistance.

An Unusual Fault.

A READER has constructed a crystal receiver from which he obtains excellent results. Recently he has carried extension wires from the telephone terminals of his receiver to a distant room of the house, but finds that results are poor, and that the tuning of the receiver has to be changed considerably when these wires are connected to his receiver, and he is puzzled by this anomalous behaviour of the receiver.

The reason for this effect is not difficult to see. When constructing the receiver, our reader has probably connected his crystal directly to the earth side of the aerial coil instead of to the high potential side. This means that one side of the detector is earthed directly and the other through the capacity of the telephones. The capacity between the long extension leads and earth has the effect of by-passing a large amount of the H.F. current which should be rectified by the crystal, and this fault should therefore be remedied at once. A simple method is to connect the aerial lead-in to the earth terminal of the receiver, the earth lead being connected to the aerial terminal. In addition to this it is always advisable to employ an output transformer of 1 to 1 ratio whenever extension leads are to be employed, irrespective of whether a valve or crystal receiver is employed.

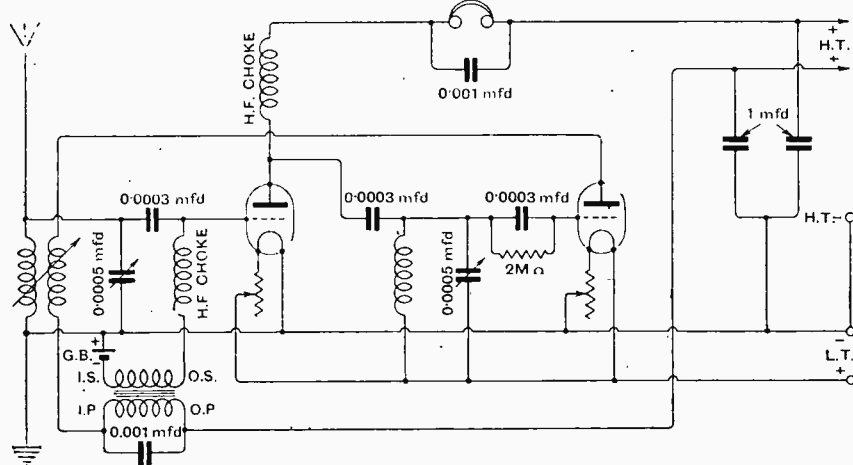

Fig. 3.—Reflex circuit employing the "parallel-feed" system of connections.

The Wireless AND RADIO REVIEW World

No. 320.

WEDNESDAY, SEPTEMBER 30TH, 1925.

VOL. XVII. No. 14.

Assistant Editor:
F. H. HAYNES.

Editor:
HUGH S. POCKOCK.

Assistant Editor:
W. JAMES.

Editorial Offices: 139-40, FLEET STREET, LONDON, E.C.4

Telephone: City 4011 (3 lines).

Advertising and Publishing Offices: DORSET HOUSE, TUDOR STREET, LONDON, E.C.4.

Telephone: City 2847 (13 lines).

Telegrams: "Ethaworld, Fleet, London."

COVENTRY: Hertford Street.

BIRMINGHAM: Guildhall Buildings, Navigation Street.

MANCHESTER: 199, Deansgate.

Telegrams: "Cyclist Coventry."
Telephone: 10 Coventry.

Telegrams: "Autopress, Birmingham."
Telephone: 2970 and 2971 Midland.

Telegrams: "Hiffe, Manchester."
Telephone: 8970 and 8971 City.

Subscription Rates: Home, £1 1s. 8d.; Canada, £1 1s. 8d.; other countries abroad, £1 3s. 10d. per annum.

As many of the circuits and apparatus described in these pages are covered by patents, readers are advised, before making use of them, to satisfy themselves that they would not be infringing patents.

THE COMING OF AGE OF THE THERMIONIC VALVE.

JUST twenty-one years ago, or to be precise in October, 1904, there came into existence the elementary and at that time undeveloped piece of electrical apparatus which to-day is known in almost every household in every civilised country in the world.

The Birth of the Valve.

It was in October, 1904, that an electrical engineer, John Ambrose Fleming, who had already established a name for himself in his profession, whilst studying phenomena which had been more or less casually observed by Edison, and pursuing his investigations, discovered the practical application of the theoretical property of the valve. In the following month the fundamental patent in connection with the thermionic valve invention was granted to J. A. Fleming by the British Patent Office under date of November 16th, 1904. The number of the patent was 24,850, and the title, "Improvements in Instruments for Detecting and Measuring Alternating Electric Currents." In this specification was described for the first time the construction of a bulb of glass or other material exhausted of air and containing a filament which could be rendered incandescent, surrounded by a cylinder of metal carried on a wire sealed through the bulb; the application of this device being for rectifying high-frequency electric currents and, therefore, for detecting electric waves as used in wireless tele-

graphy. Valves precisely as specified in this first patent are used to-day for rectifying electric currents, but the use is not now as a detector in wireless, although for years it was so used, but for rectifying high voltage low-frequency alternating currents to supply the direct voltage required for the anodes of transmitting valves.

CONTENTS.

	PAGE
EDITORIAL VIEWS	415
THE THERMIONIC VALVE	417
By Prof. J. A. Fleming.	
UNSOLVED VALVE PROBLEMS	423
By Prof. E. V. Appleton.	
VALVE DATA	426
READERS' NOVELTIES	427
CURRENT TOPICS	429
VALVES WE HAVE TESTED	430
The Burndept Series.	
NEWS FROM THE CLUBS	452
BROADCAST BREVITIES	433
VALVES IN THE MAKING	435
PRACTICAL HINTS AND TIPS	443
THE SELECTION OF A VALVE... .. .	445
By N. V. Kipping and A. D. Blumlien.	
LETTERS TO THE EDITOR	450
READERS' PROBLEMS	451

Valve History Inseparable from Patent Records.

The early history of the development of the valve is inseparable from Patent Office records and, therefore, we take this opportunity of making reference to some of the early patents which have a bearing on the subject.

Corresponding patents to the British Patent No. 24,850 of November 16th, 1904, were taken out in Germany and the United States in 1905 under the numbers 186,084 and 803,684 respectively.

Some ten years later the United States patent came into litigation when the De Forest Radio Telephone and Telegraph Company of America was sued by the Marconi Co. for infringement. The claims of the Fleming patent were upheld in judgment in the American courts given in September, 1916,

and further upheld the following year after an appeal by the defendants.

De Forest's Third Electrode.

To Dr. Lee De Forest, of America, is due the credit for the introduction of the grid or third electrode, which in its original form had a zigzag wire placed between the fila-

ment and the plate of the Fleming valve, thus converting it from a rectifier and detector into an amplifier of oscillations and making what is, in effect, the forerunner of the three-electrode valve of to-day. The decision of the American courts in the action brought by the Marconi Co. was that the "De Forest audion," as his three-electrode valve was termed, although it possessed independent validity, constituted an infringement of the Fleming patent.

The British Fleming patent expired in 1918, and when a petition was presented for prolongation by the Marconi Co., who were the owners of the patent, it was dismissed on the ground that the owners had received sufficient consideration for it during its life; but it is interesting to note that the judge referred to the invention as one of "unusual utility."

Dr. Lee De Forest's British patent was applied for on January 21st, 1908, but the effective date under patent convention is January 29th, 1907, being the date of application for the equivalent patent in the United States. It is a remarkable fact that this British patent was allowed to lapse in 1911.

Later Developments.

Passing on to later developments in the valve, we find that the use of Tungsten for a material for the incandescent filament was referred to first by Dr. Fleming in a British Patent No. 13,518, dated June 25th, 1908, and in this specification is also described the potentiometer method for controlling the potential of the third electrode.

The use of oxide-coated filaments for the purpose of increasing the filament emission was patented in Germany by Dr. Wehnelt in 1905. A three-electrode valve was described and patented by three Austrian engineers, Lejben, Reisz and Strauss, in British Patent Specifications No. 1,482 and No. 2,111 of 1911, and in this valve an oxide-coated filament of the Wehnelt type was employed.

The French "R" Type Valve.

A notable advance in valve design was described and patented in France in October, 1915, by Messrs M. Péri and J. Biguet, the equivalent British patent being October 23rd, 1916. This design comprised a straight filament of drawn Tungsten surrounded by a nickel spiral wire grid and a cylindrical anode, the connections being taken to four insulated pins in the base of the valve. This is the valve which is commonly known as the "R" type valve and was used ex-



Dr. J. A. Fleming, F.R.S.

tensively during and after the war for detection and amplification.

These references to early valve patents we make because so many persons have only recently been introduced to wireless and cannot, therefore, be familiar with these points of early history.

Thousands of Valve Patents.

The British and foreign patents which have been taken out for thermionic valve invention and improvements would literally run up to thousands, but there are, of course, amongst these a very large number which would never stand up to close investigation in a court of law; in fact, the position with respect to wireless valve patents to-day is a very uncertain one, and any legal action would involve the parties concerned

in most complicated and intricate arguments in the effort to establish rival claims. Probably the only wireless valve patent which has had to stand the test of legal bombardment and has emerged triumphant is the fundamental valve patent of the two electrode valve which in the early days was known as "Fleming's Glow Lamp Wave Detector."

Just how much the valve has been directly responsible in bringing about the development of wireless communication, and particularly broadcasting, to its present state of perfection, it would, of course, be difficult to estimate. It may be said, however, that if the valve had not been available, then human ingenuity might probably have been diverted to some other channel and have developed some new type of apparatus which would have performed the work equally well.

There is, of course, the possibility that the arc might have replaced the valve in so far as transmission is concerned, particularly if the same attention had been paid to that instrument as has been given to the perfecting of the valve.

There seems little doubt but that we have not yet attained the ultimate degree of efficiency from the valve even in its present highly developed state. Improvements are still being made almost from day to day, and with each progressive step taken the efficiency of the thermionic valve is enhanced. Processes in the manufacture of the valve have naturally progressed as the importance of the valve and the demand has increased. The scale on which valves are produced at the present time may be judged from the articles on valve manufacture appearing in this issue.



Dr. Lee De Forest.

The THERMIONIC VALVE

Its Origin and Development.

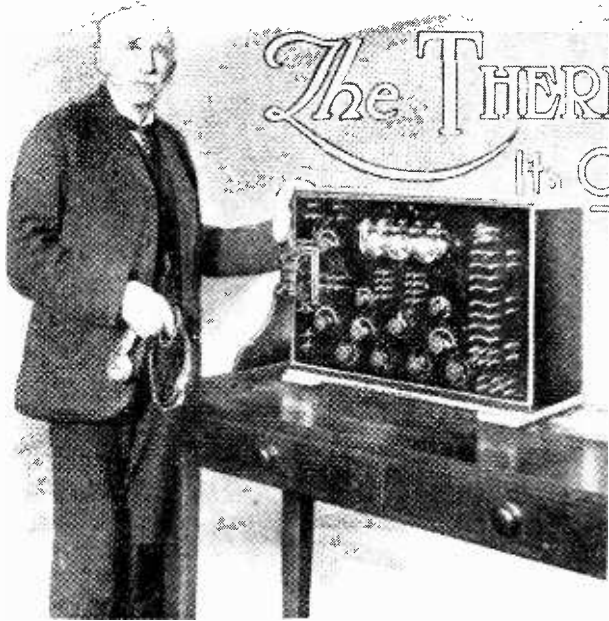

"The History of the Thermionic Valve Forms One of the Most Astonishing Chapters in the Long Record of Scientific Research and Invention."

By Dr. J. A. FLEMING, F.R.S.

MANY electrical inventions of great importance are extremely simple in structure or nature, so much so that they appear to be almost obvious things for which little credit need be given to any particular inventor or originator. Nevertheless, that simplicity is their chief merit, and it has in nearly all cases only been obtained after innumerable trials and failures with more complicated contrivances. We need only mention as illustrations such inventions as the speaking telephone of Bell, the incandescent filament electric lamp of Edison and Swan, and the thermionic valve, the origin of which is the subject of the present article.

Like the speaking telephone and the incandescent lamp, the thermionic valve has rendered possible the creation of an immense industry based entirely upon it, since without the valve there would be no broadcasting, therefore no enormous manufacture of wireless telephony receiving apparatus, no construction of broadcasting stations, or large periodical literature which now instructs the amateur or aids research in the art of wireless telephony. Nay, more, there would be no long-distance wireless telegraphy or the wonderful beam system, and no possibility of inter-communication with aeroplanes or directional wireless for ships.

The thermionic valve, in

short, is the chief foundation stone of modern radiotelegraphy and radiotelephony, and the amazing progress of these arts, giving employment to hundreds of thousands of persons, is the direct result of the invention and development of this marvellous appliance. Hence it becomes interesting to look into its history, explore the stages of its evolution, and examine the nature of the scientific researches which brought it into existence.

Inventions Develop Gradually.

Scientific invention is subject to the law of evolution.

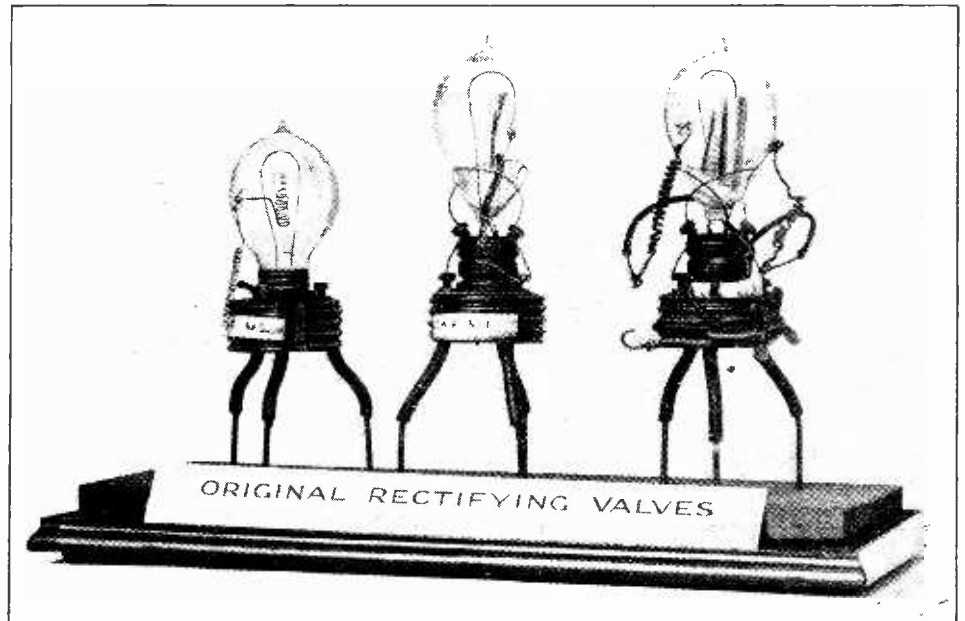

(Courtesy, Graphic Photo Union.)

Fig. 1.—Three of the first valves devised by Dr. Fleming

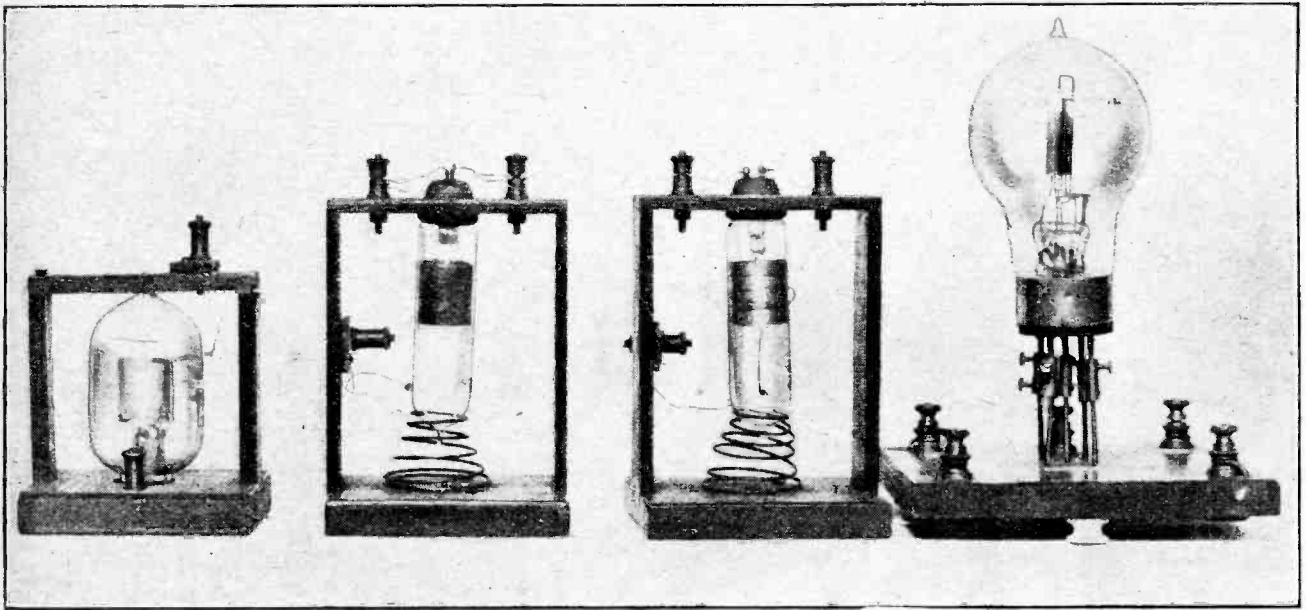

(Courtesy, Graphis Photo Union.)

Fig. 2.—Types of early Fleming valves, and one of more modern type.

Things do not spring into being full grown and at once, as in classical fable Minerva is said to have sprung full grown from the head of Jove. They proceed by small stages, and a careful examination shows that the pivotal ideas, observations, or inventions, were contributed at particular times by particular persons who had the insight to make them at the appropriate moment.

There is no necessity to encumber our narrative with any lengthy references to the history of wireless telegraphy. There is only one type of telegraphy which matters at the present time, in which an inter-connecting wire is unnecessary between the sending and receiving stations, and that is the electromagnetic wave or radiotelegraphy. We cannot forget nor forbear to mention that the scientific conception of an electromagnetic wave originated in 1865 with James Clerk Maxwell, whose death in 1879 at the early age of 49 deprived the world of one of its most original scientific thinkers. Twenty years had to elapse, even in spite of suggestions by another great philosopher, G. Fitzgerald, before H. R. Hertz, with his immense genius for experimental and theoretic research, gave us the means of creating, and in a rudimentary manner detecting, Maxwell's electric waves. When once it had been clearly recognised that beyond the actinic, luminous, and dark heat vibrations in the ether there is an almost unlimited range of longer waves to which the photographic plate, human eye, and thermopile are insensitive, immense interest began to be taken in the possible modes of generation and detection of these longer waves. The insensitive

spark gap detector of Hertz was soon replaced by the coherer of Branly and Lodge, and by it much useful work was done. Then came an era when a few select minds, such as those of Admiral Sir Henry Jackson, Sir William Crookes, Mr. Campbell Swinton, and especially Senatore Marconi, saw that this long wave radiation might be used for telegraphic purposes.

Marconi's great invention of the aerial and earth connection and his improvement of the Branly-Lodge coherer into a more certain type of wave detector translated ideas and suggestions into actual achievement, and he gave us a slow but veritable radiotelegraphy by electric waves. On this basis, with the improved spark transmitter invented by Marconi, as described in his celebrated British patent, No. 7777 of 1900, and with the embodiment of the principles of syntony or tuning described in Lodge's 1897 British specification, spark radiotelegraphy came into existence as a practical art of immediate and immense assistance to ships and voyagers.

The invention of the arc-transmitter by Poulsen's improvement on the Duddell arc-oscillation generator, first made continuous wave radiotelegraphy possible. Meanwhile the coherer had been replaced as a detector of the feeble oscillations induced in the receiving aerial by the magnetic detector of Marconi, and forms of self-restoring coherer and electrolytic detector tried with limited success. What was required and being looked for by many was a detector which would not require the careful adjustments of the tapped coherer and be more sensitive than existing detectors.

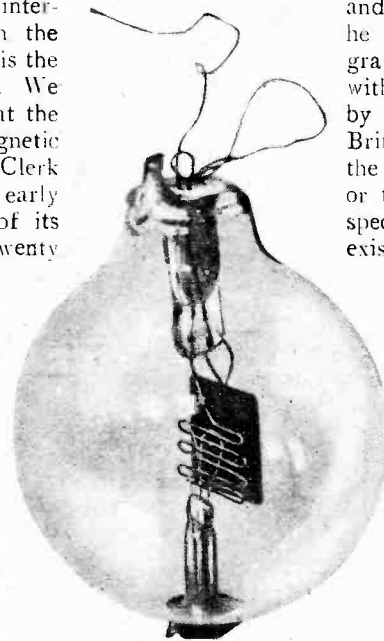

(Courtesy, Science Museum, South Kensington.)

Fig. 3.—An early de Forest "audion," showing the introduction of the grid.

The Thermionic Valve.—

The writer of this article had turned attention from its very earliest days to the subject of electromagnetic radiation. He may, in fact, describe himself as having been a personal pupil of Clerk Maxwell, since he relinquished in 1877 a teaching post at Cheltenham College to go up to Cambridge chiefly with the object of working under Maxwell in the then recently erected Cavendish Laboratory. There for two years he enjoyed Maxwell's stimulating teaching and intercourse. In the year that Maxwell died the writer was appointed scientific adviser of the Edison Telephone Company of London, and three years later to a similar position with the Edison Electric Light Company, formed to introduce incandescent electric lighting into London. This close connection with electrotechnics gave an opportunity for the study of certain physical appliances on a scale quite impossible in the laboratory. The incandescent electric lamp, invented by Edison, consisted of a horse-

shoe-shaped filament of carbonised bamboo sealed into an exhausted glass bulb. The filament was necessarily not quite uniform, and, when heated by a current, some parts became hotter than others. The carbon also volatilised and was deposited as a black coating on the bulb. The writer noticed many cases of blackened



(Courtesy, Sir Henry Norman and the Science Museum.)

Fig. 4.—An early type of receiving valve due to Messrs. Lieben and Reisz, two Austrian engineers.

lamps in which there was a white line or no deposit in the plane of the filament loop, and on the opposite side of the loop to that on which the filament had burnt through. This clearly indicated that there had been a projection of carbon particles in straight lines from that hottest spot on the carbon loop. Observations on this subject the writer communicated to the Physical Society of London in 1883. The writer's attention was then called to an observation of Edison's when he sealed a metal plate into the lamp bulb, this plate standing between the legs of the horse-shoe filament. When the filament was rendered incandescent by a direct current it was found that a galvanometer connected between the positive terminal of the filament and the plate indicated a small direct current, but that when connected between the plate and the negative end of the filament gave no sensible current. Edison gave no explanation of this effect, and made no application of it that had the smallest reference to rectifying electric currents.

Early Investigations.

The writer made a very extensive investigation of the effect in the years 1885 to 1890, and was thereby led to the conclusion that there was an emission of particles chiefly from the negative leg of the filament, which were

charged with negative electricity. Those days were long before Sir Joseph Thomson had made his remarkable discovery that there are particles smaller than chemical atoms in a high-vacuum electric discharge tube, and the writer had therefore concluded that these charged particles must be atoms of carbon which were thrown off from the filament, and that each carried a negative charge.

Effect of a Plate.

It was proved by the writer, experimentally, that this torrent of electrified particles was stopped by a mica or metal plate, but could pass through the apertures in a metal grid or zigzag of wire. Also it was proved that when the two electrodes in a vacuum tube were made of carbon filaments, a very small direct voltage could create a sensible current through the rarefied gas, provided that the negative electrode was made incandescent. It was not until 1899 that Sir Joseph Thomson demonstrated that these charged particles emitted by incandescent carbon in vacuum were electrons, having only 1-1,800th the mass of a hydrogen atom, but each carrying the same electric charge as a hydrogen ion in electrolysis. Meanwhile wireless telegraphy by electric waves had been invented and put in practice by Marconi, and in April, 1899, he astonished the world by achieving wireless telegraphy across the English Channel. In September, 1899, the writer lectured before the British Association at Dover on the centenary of the electric current, and remarkable cross-Channel demonstrations of electric wave telegraphy were made by Marconi's Wireless Telegraph Company. In 1900 the writer became connected with that company as scientific adviser, and was entrusted with the duty of specifying and assisting to design the earliest transmitting plant prepared for trans-Atlantic wireless experiments.

Need for a Simple Detector.

In this work it had become clear to the writer that some simpler and more easily managed detector must replace the coherer if speeds of signalling were to be attained comparable with those on submarine cables. The writer was well acquainted with the apparatus used in cable telegraphy, and it was not long before the idea occurred to him that if the feeble high-frequency alter-

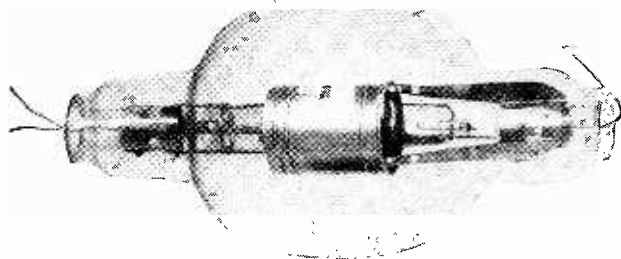

Fig. 5.—A high-power rectifying valve of recent design, but theoretically the same as the Fleming valve.

nating electric currents induced by the waves in the receiving aerial could be "rectified," that is, converted into direct currents, we could then use a mirror galvanometer or syphon recorder to detect them. Accordingly, many experiments were made with devices having unilateral conductivity, but only after a time was it found by the writer that a perfect device existed in a high

The Thermionic Valve.—

vacuum tube containing two electrodes, one of which was rendered incandescent by a current.

Finally, in October, 1904, the invention was made of a thermionic "valve," consisting of a carbon filament electric lamp in which the loop filament was surrounded by a metal cylinder, the latter connected to a wire sealed through the glass bulb. When the filament is rendered incandescent by a current, the space between the filament and the cylinder acquires a unilateral conductivity and allows negative electricity to pass from the filament to the cylinder, but not in the opposite direction, and can therefore convert high-frequency alternating currents into direct currents. All that was necessary, therefore, was to include this filament and cylinder rectifying space in series with a galvanometer to detect such currents. When using spark oscillations, which come in groups or trains, a telephone could be used instead, and each train therefore gave a single sound in the telephone, and the groups of trains constituting the signals gave audible dash and dot signals. This was produced and patented in Great Britain on November 16th, 1904—the now well-known "Fleming valve." It began to be used in practical wireless reception by Marconi's Wireless Telegraph Company very soon after, and provided an easily managed detector not liable to be put out of adjustment by atmospherics. It was, in fact, used for experimental reception across the Atlantic before long. This valve was absolutely the first technical application of the emission of electrons from an incandescent conductor in vacuo, and the importance of the invention is not to be measured merely by the actual device then first patented by the writer, but by the degree to which it opened up an entirely new field of research and invention. The present year 1925 may therefore be called the year of the "Coming of Age" of the Thermionic Valve.

Importance of the Invention.

The importance of the invention is also shown by the determined attempt made by American wireless men to claim the invention for themselves and deprive the present writer of credit for it and remove his name from connection with it by re-christening identically the same invention by other strange names, such as Audion, Kenotron, Tungar or Diode. The name "valve," first given to it by the writer, is a simple, appropriate, easily pronounced English word of five letters, and has now become so firmly fixed in British wireless language that it will never be displaced by other outlandish words.

The endeavour on the part of one United States patentee to claim the invention for himself gave rise to much prolonged litigation, but the decisions of a Court

of First Instance, given by His Honour Judge Mayer, later on confirmed by the unanimous decisions of three judges in the United States Court of Appeals, settled the question beyond dispute that the writer was the first and true inventor of the rectifying thermionic valve, by whatever name it may be called. In Great Britain Mr. Justice Sargant, in 1918, declared the invention to be one of "unusual utility," and that, in his opinion, the three-electrode valve would never have come into being but for the previous invention of the 1904 Fleming valve.

The early Fleming valves were made with carbon filaments, but in 1908 the writer found that tungsten wire possessed advantages in that it could be heated to a higher temperature. Also, in a British Patent specification first mentioning this, he described a method of using the valve for reception which consisted in applying to the anode circuit such a voltage that it brought the point of working on the characteristic curve just to a place where that curve has a change in curvature. This method is capable of giving great sensitivity in the case of certain *soft* valves.

The great use of this rectifying valve now is not to rectify the feeble high-frequency oscillations in receiving sets, but to rectify a low-frequency but high voltage electromotive force required to keep the anodes of three-electrode valves at a high direct potential.

This leads us to the next stage in the invention, namely, the means for controlling the electron flow from the filament to the anode cylinder. In experiments described to the Royal Society of London, in 1905, the writer had shown that a source of e.m.f., now called an anode battery, might be inserted in series with the valve, and that the electric conductivity of the vacuous space between hot filament and cold cylinder or anode depended upon this voltage.

In the paper above mentioned he gave the first delineation of the curve now called a characteristic curve of the valve expressing the relation between impressed voltage and anode current.

Introduction of the Grid.

The writer was well aware that this current could be reduced by holding near the valve a permanent magnet, but unfortunately it did not occur to him in sufficient time that this anode current could be controlled by inserting a grid or spiral wire or metal mesh cylinder between the anode cylinder and the filament, and giving to this grid small positive or negative potentials. This, however, was done in a rudimentary form in 1907 by Lee de Forest in the United States, who had been following carefully the work of the writer. De Forest interposed a zigzag of wire carried on a separate terminal between the anode plate and filament, and thus made the first form of three-electrode valve, or, as it is sometimes called, triode. The introduction of the grid or controlling electrode was

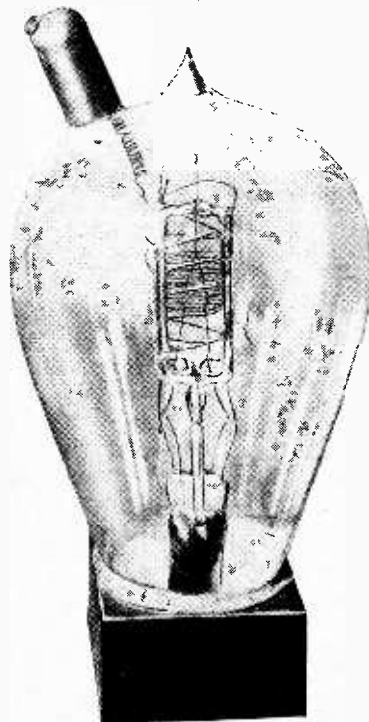

(Courtesy, Science Museum.

Fig. 6.—An early specimen of a type of valve known as the "pitotron."

The Thermionic Valve.—

of great importance; it enabled the valve to become not only a detector but an amplifier for electric oscillations.

The next step in invention involved the improvements in making the vacuum. The writer had specified in his patent specifications that the vacuum should be as high as possible, but the attainment of that aim was limited by the power of the vacuum pumps then in existence. Prior to 1904 only modifications of the Sprengel mercury pump were available, as used in incandescent lamp manufacture. But even an exhaustion to a millionth of an atmosphere leaves still some ten billion molecules of air per centimetre cube in the bulb. In 1904 Sir James Dewar gave us his beautiful process for making high vacua by charcoal cooled with liquid air. Soon after Gaede invented the molecular pump, and at a later stage Irving Langmuir the mercury condensation pump. Still more recently Holweck has given us an improved molecular pump, and there have been several modifications of the mercury vapour injector pump. The result has been to render possible far higher vacua, and the process of exhaustion is now aided by chemical means by introducing metallic magnesium into the bulb which absorbs the residual oxygen and nitrogen. The result is a *hard* or high vacuum valve in which the whole of the anode current is conveyed by electrons which come out of the filament, and no ionisation of gas molecules takes place.

Generation of Oscillations.

Another great stage of improvement was when it was discovered that the valve could act as a generator of oscillations both in its two- and three-electrode form. In the latter type the grid and cylinder circuits are coupled together inductively in such fashion that the changes of current or potential in each circuit tend to augment each other. When once this had been discovered it rendered it possible to employ the valve in an improved manner by means of so-called reactive coupling as a more sensitive detector, as done first by C. S. Franklin and E. H. Armstrong. Also, by gradual stages larger and larger bulbs were employed in generating valves of gradually increasing power.

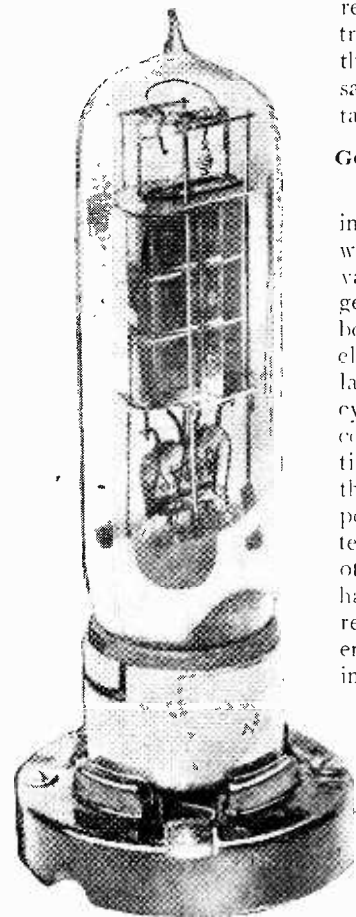

(Courtesy, Science Museum.)
Fig. 7.—An American valve of large dimension—the U.V. 203A. Suitable for low power transmitting.

This is the place to say a word or two about improvements in the emitting filament. After carbon, with its rather low volatilising temperature, hard drawn tungsten wire, came to be employed, since it has a very high melting point (near 3,500° C.), and the electron emission increases rapidly with temperature. The Western Electric Company, of America, made a departure in the use of an oxide-coated metallic filament. It was discovered by Wehnelt that the oxides of earthy metals had the power of greatly increasing the electron emission of hot metals. The Western Electric filament is, therefore, made of a thin strip of platinum-iridium or other metal coated with oxides of barium and strontium.

Further Improvements.

Another important discovery was that thorium had a similar power when placed on tungsten, and that a thoriated filament could give the required emission for detector valves at a dull red heat. Hence came the so-called "dull emitter" valves, which can be worked with one or two dry cells for reception.

Other great improvements were made in the bulb. In large transmitting valves the electron emission from the filament bombards the anode cylinder and makes it red-hot. This heat has to be dispersed by radiation, and with very large glass bulbs there is great risk of fracture. One great advance was in the use of silica for the bulb, because it can be heated and cooled unequally without risk. The Mullard Valve Company have very successfully grappled with the problem of making silica-bulb high-power transmitting valves.

The greatest advance was made when it was discovered that the anode cylinder could form part of the bulb, and thus, being external, could be water-cooled. This was rendered possible by the discovery that a copper or copper-plated nickel tube with sharp edge could be sealed to a glass tube.

The cooling of the anode cylinder enables generating valves of very large power to be made, even up to many hundred kilowatts output; by this invention it is now possible to equip high-power stations entirely with valve generators. In fact, it is doubtful if either the Poulsen arc or the high-frequency alternator will be able to compete with the valve as the radio generator of the future.

The high-power generating valve may involve in the future only an incandescent rod of tungsten and a water-cooled enclosing anode, and, in fact, be a simple improved type of Fleming valve.

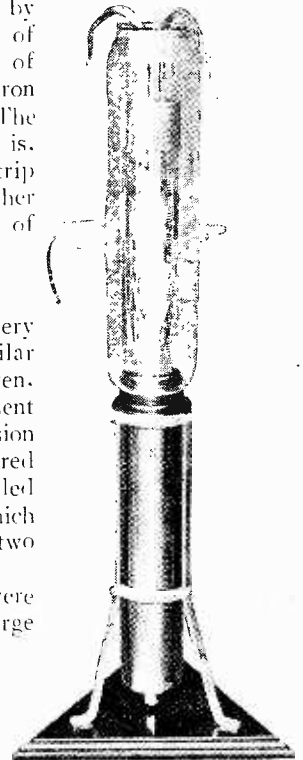

(Courtesy, Science Museum.)
Fig. 8.—A high-power valve of very modern type employing a water-cooled anode.

The Thermionic Valve.—

When a filament is heated by a current the magnetic field round it tends to prevent the escape of electrons. Hence, if that current is an alternating current, the electrons escape to the anode or gushes at the instant when the heating current passes through its zero valves. If, then, that intermittent anode current is passed through a transformer, the secondary current will be a pure alternating current of double the frequency of the filament-heating current. In this manner it may be possible to step-up frequency and create powerful high-frequency oscillations.

It is now nearly 21 years since the writer invented and gave to the radiotelegraphic art the simple two-electrode rectifying valve, but that invention has been proved to possess a wonderful fertility and stimulated the inventive powers of many able minds, so that in the short space of two decades we have become possessed

of an appliance having the most astonishing range of properties for the generation and detection of Maxwell's electromagnetic waves, and of which we have not yet exhausted all the possibilities.

In its power of creating short electric waves it has no rival, and it has been the starting point for the great inventions resulting in the marvellous beam system of radiotelegraphy of Senatore Marconi, perhaps the most remarkable of his many great inventions, in the development of which he has been so ably assisted by Mr. C. S. Franklin.

The history of the thermionic valve forms one of the most astonishing chapters in the long record of scientific research and invention. At one end of the chain we have the initial observations of the writer on some curious effects in connection with blackened carbon filament incandescent lamps, and at the other end a perfected appliance which enables a single human voice or musical instrument to make itself heard almost over the whole habitable surface of the globe.

TRANSMISSION ON 40 METRES.

The Work of the G.E.C. of America.

AN interesting aerial system for short wave transmission is undergoing exhaustive tests in the famous G.E.C. laboratories, Schenectady, U.S.A.

On wavelengths of the order of 40 metres there is no object in using an aerial of the inverted L type, and it is customary to employ a single vertical wire as a radiator. The symmetry of the electrostatic and magnetic fields surrounding the vertical wire aerial enables many of the transmission phenomena to be treated mathematically and the development of more efficient methods of excitation is thus facilitated.

The aerial employed by the G.E.C. engineers is known as a vertical doublet, and is a single vertical wire suspended from a wooden mast about 60ft. in height, wood being employed to reduce eddy currents and re-radiation effects. The wire is tuned by low loss inductances connected at the mid-point and a hot-wire ammeter is mounted on a wooden frame and connected between the coils.

The photograph shows the tuner unit lowered for inspection. Normally, the tuner unit is 30ft. above ground level, and it is therefore necessary to use a telescope to read the aerial current.

The aerial is capacity-coupled to the valve oscillator, the coupling condenser and feed tuner being housed in a weatherproof box at the base of the aerial mast. The remainder of the transmitting apparatus is situated in an adjacent hut, and receives input power over land lines from the main power building. The feed tuner is connected to the main transmitter by two parallel leads, passing through bushes in one of the plate-glass windows of the hut.

No regular times for transmission have been adopted, but the station is in operation on most week days during the afternoon and evening, the call sign being 2XAF.

In view of the extraordinary resources of the G.E.C. laboratories, we may look for many new and original methods of short-wave transmission in the near future.

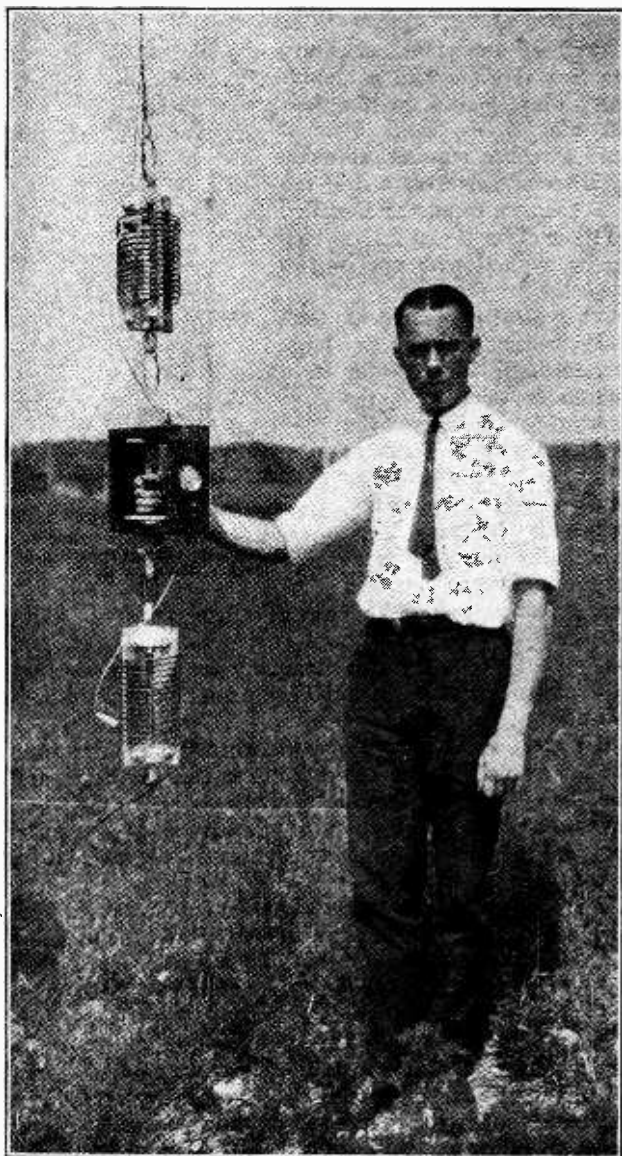

UNSOLVED VALVE PROBLEMS.

An Explanation of Some Curious Emission Effects.

By PROF. E. V. APPLETON, M.A., D.Sc.

IN spite of the immense amount of work that has been carried out within the last ten years on thermionic valves there are still plenty of problems for the experimenter, and many fundamental points in connection with valves on which our information is not wholly complete. I propose, in this article, to consider one or two problems which have cropped up in the course of my own work, and which may be regarded as typical of the problems yet awaiting solution. It is possible that the article may suggest to the experimenter, who is equipped with galvanometers, ideas for testing in various ways the explanations I put forward. I shall assume that the reader is familiar with the general disposition of the electrodes in a triode and with the way in which the low- and high-tension batteries are usually connected.

Time Lag in Valve Circuits.

Now the fundamental characteristic of a thermionic valve is that it is a type of conductor in which the current through it is controlled by the potentials of the electrodes, and it is natural for us to want to know whether there is any lag in the action of the valve, or, in other words, whether an appreciable time is required for the current to reach its final value when the voltage is changed. The first problem I wish to discuss is, therefore, the quickness of response of a valve.

The first indications that the action of a valve was not instantaneous were obtained by Dr. van der Pol and the

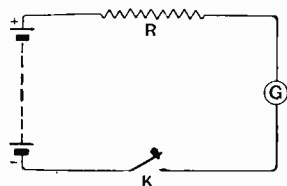

Fig. 1a.

Circuits used to compare the electrical response of (a) a non-inductive resistance and (b) the anode-filament circuit of a thermionic valve. An Einthoven string galvanometer G is used to record the growth of current in the circuit.

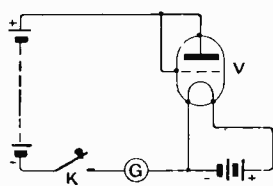

Fig. 1b.

writer in an oscillographic study of an oscillating valve. Oscillographic records were obtained of the current changes when a battery circuit was closed (a) through an ordinary non-inductive resistance, and (b) through a thermionic valve. The circuits used are shown in Figs. 1a and 1b, where G represents an Einthoven galvanometer, and K the key for closing the circuit. The non-inductive resistance of Fig. 1a is replaced in Fig. 1b by the valve V.

Copies of the oscillographic records are shown respectively in Figs. 2a and 2b. In Fig. 2a we note that the current remained at zero value until the time marked X was reached, when the current reached its final value practically instantaneously and maintained that value. On the other hand, in the case of the valve (Fig. 2b), the current, after increasing practically instantaneously to a

certain value, fell by about 12 per cent. to a value which was maintained. The time for the stationary state to be attained was about a quarter of a second. Now it seems fairly certain that we cannot attribute this curious property of a thermionic valve to lag in the motion of the electrons, for it is easily shown that an electron under

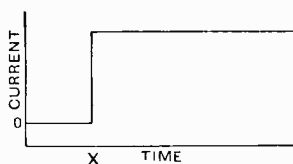

Fig. 2a.

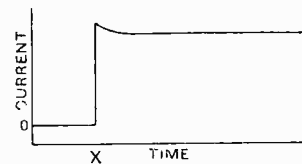

Fig. 2b.

Oscillograph records obtained with the corresponding circuits in Fig. 1.

the conditions of the experiment takes only a hundredth of a micro-second to go from filament to plate. The response of the electrons to the potential must be practically instantaneous, and we therefore consider what other factors are responsible for this comparatively slow change of thermionic current.

Cooling of the Filament.

If we compare Fig. 1a and 1b, we notice that the main difference between the resistance R and the valve V is that the latter has attached to it a battery which is necessary for heating the filament and rendering the valve conducting, and a closer consideration of this difference eventually led to the explanation of the drop in valve current following the closing of the anode circuit. It was found that we have to consider the action of the anode current itself on the emission of the filament and to consider what changes are made in the temperature of the filament when the anode circuit is closed.

A subsidiary experiment enables us to consider the question in greater detail. Suppose we connect up a valve as a diode, as shown in Fig. 3, so that, of the three ammeters included in the circuit, A and B are used for reading the current through both ends of the filament, and C for reading the value of the anode current. Before the key K is closed, the readings of A and B will be the same. When the key is closed, however, we have the anode current superimposed on the filament current resulting in changes in the readings of A and B. The ammeter A at the negative end of the filament is found to indicate an increased reading, while the reading of the ammeter B at the positive end is reduced. The case is best illustrated by a numerical example. Let us suppose that, before the key K is closed, the filament current is 1 ampere,

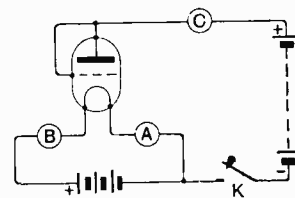

Fig. 3.—Circuit illustrating the effect of the anode current on the distribution of current in the valve filament.

Unsolved Valve Problems.—

and that when the anode circuit is closed a current of 10 milliamperes flows. In such a case the anode current, in going to the filament to be emitted, is found to divide itself between the negative and positive ends in the ratio of 7 to 3, so that the negative end ammeter is found to increase to a reading of 1.07 amperes, while the positive limb ammeter reading falls to 0.97 ampere. We thus see that, on closing the anode circuit, the current through the negative end of the filament is bigger than that through the positive end, and thus the temperature of the negative half is bigger than that of the positive half. But, although we are able to estimate the difference in the current through both halves of the filament, the really practical point to be settled is whether the emission of electrons from the filament is increased or decreased when the anode circuit is closed and current taken from the tube. It might at first sight be imagined that the increased emission from the negative end of the filament would counterbalance the loss from the cooled positive end and thus result in no appreciable alteration, but there is another factor to be taken into account. Before any anode current is allowed to flow, electrons are being emitted by the filament at a constant rate and are going back to the filament at the same constant rate, so that no energy is lost by the filament on their account. In the case where all the electrons emitted by the filament are collected by the anode, this is no longer the case, and the filament loses energy in evaporating the electrons, which it does not regain. This effect can be shown to produce a cooling of the filament which masks the other effects mentioned above, so that the chief result of closing the circuit and allowing anode current to flow is that the filament is cooled and the electronic emission reduced. Thus the cooled drop of 12 per cent. registered in the oscillograms is due to the cooling of the filament when anode current is taken from the tube.

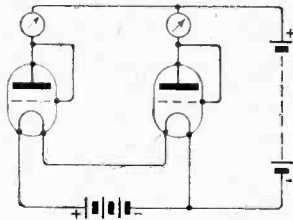

Fig. 4.—Simple experiment to illustrate the increased emission from the negative end of a valve filament under the influence of the plate potential.

An Interesting Experiment.

A very simple way of illustrating that the negative end of a filament normally emits more than the positive

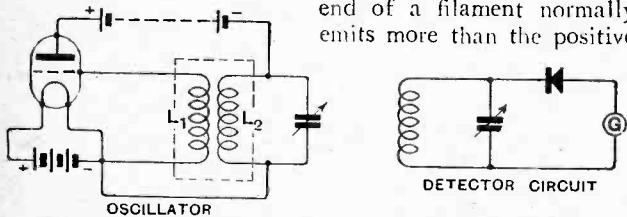

Fig. 5.—Circuit diagram of the apparatus used to demonstrate oscillation-hysteresis

end is to pick out two valves with similar characteristics and connect them up as in Fig. 4, so that the two filaments are joined in series. In a typical case, I found that the reading of the anode current from the right-hand valve (the filament of which represents the negative half of the combined filament) was 50 per cent. greater

than that of the other. Since higher filament temperature means shorter filament lives, we might expect valves to burn out more frequently at the negative end of a filament than at the positive, and I should be very interested to hear from readers whether they have any experience on this point.

Oscillation Hysteresis.

I now turn to a different type of problem, which relates to the use of a valve in a regenerative circuit. The problem is of importance in broadcast reception, and can best be illustrated by an example. One evening when listening to 2LO at Cambridge I noticed that atmospherics due to local lightning were arriving at the rate of about one every two minutes. A neighbouring listener had his set so adjusted that after each crash the set was left oscillating, resulting in the usual heterodyne note. As the note presumably interfered with reception, he stopped his set from oscillating each time and then adjusted it afresh. I imagine that he adjusted it to about the same reaction value, for it was caused to oscillate violently by every atmospheric.

The above example illustrates a very interesting property of a valve oscillator which I call oscillation-hysteresis. An oscillating circuit may be stable with either a zero or a finite amplitude, and may be made to jump from the zero to the finite value by an electrical impulse. This property was considered by some workers to be due to some hysteresis in the action of the valve due to gaseous ionisation, but this is not the case. The effect is due to the shape of the valve characteristic, and is always present to some extent when the valve is used at conditions represented by the two curved portions of the ordinary static characteristic.

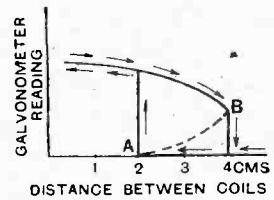

Fig. 6.—Curve showing relation between the current in G and the distance between the coils L₁ and L₂ in Fig. 5.

The phenomenon can best be illustrated by a simple experiment which can be carried out by anyone possessing a sensitive galvanometer. In Fig. 5 is shown the circuit of an ordinary valve oscillator to which is very weakly coupled an ordinary oscillatory circuit with crystal and galvanometer. Let us suppose that we start with the two coils L₁ and L₂ far apart (weak coupling) and very gradually bring them together. At a certain distance apart, say 2 cms., we find that an oscillation starts suddenly, as is shown by the deflection of the detecting galvanometer, and this oscillation increases only slightly as the coils are brought nearer, say, to 1 cm. When, however, the reaction is reduced by increasing the distance between the coils, it is found that the oscillation persists until the distance is increased to, say, 4 cms. These changes are illustrated in Fig. 6, where the relation between galvanometer deflection and coupling is plotted.

From this diagram we can discuss the various cases that might occur. If the distance between the coils is greater than 4 cms., no self-oscillation can occur, and the set is irreproachable from the listener's neighbour's point of view. If the coupling is between 2 and 4 cms., the set will remain in a non-oscillating condition in the

Unsolved Valve Problems.—

absence of a disturbance, but it can be caused to oscillate by an atmospheric which produces a temporary oscillation of an amplitude higher than the value indicated by the dotted line AB. It will be noted from the diagram that the disturbance necessary to start an oscillation is smaller when the coupling is $2\frac{1}{4}$ cms. than when it is $3\frac{3}{4}$ cms., and it is therefore obvious that, unless interference is almost absent, it is not safe to approach too near the critical value of 2 cms. If the coupling distance is less than 2 cms. the set will tend to oscillate freely, and, unless the oscillation is feeble enough to be synchronised by the carrier wave, a heterodyne howl will be produced.

The type of hysteresis described above I call oscillation hysteresis of the first kind. But there is another type which is sometimes observed. Sometimes it is possible to have a regenerative set oscillating with one of two amplitudes for the same coupling value. In such cases it is possible to make the oscillation jump from the lower to the higher amplitude by means of an electrical impulse. This phenomenon I call oscillation-hysteresis of the second type.

Anode and Grid Current Curves.

I now turn to the third type of problem—that of explaining the shape of the characteristics of thermionic valves in terms of the internal action of the valve. But first I must point out that workers on this problem are by no means satisfied that everything is clear, and that every peculiarity of the characteristics can be explained quantitatively. Much fundamental work yet remains to be done. I shall only have space here to deal with one of the many different points that have to be discussed, but perhaps this will serve to indicate the type of problem which is still awaiting a complete solution.

The problem is best illustrated by the anode and grid characteristics of a typical thermionic valve which are shown in Fig. 7.

In this figure the variation of anode current I_a and grid current I_g with grid potential V_g is exhibited. The anode potential V_a is maintained constant. Now these characteristics show that when the grid potential becomes higher than the anode potential the grid current increases

rapidly at the expense of the anode current, although the sum of the two is practically constant. At one time the theory advanced to explain this interchange of current was that when the grid potential became higher than the anode potential the grid began to "snatch" electrons from the main stream passing to the anode, and thus the grid current was increased at the expense of the anode current. In the *Radio Review* of September, 1921, an alternative theory was advanced by the writer. It was suggested that, due to bombardment of the anode by the electrons from the filament, secondary electrons were produced which were not collected by the grid until the grid potential became higher than the anode. The interchange of current was in such cases a measure of the secondary electrons emitted by the anode and collected by the grid. This secondary emission theory was strongly

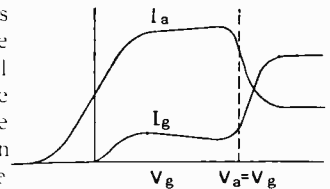

Fig. 7.—Anode current (I_a) and grid current (I_g) curves for grid potentials (V_g) comparable to the anode potential (V_a).

attacked by A. C. Bartlett (*Radio Review*, November, 1921), who maintained that the "snatching" theory was sufficient to maintain this curious kind of characteristic. It had, of course, been shown by Hull and others that secondary electrons were produced at high voltages, e.g., 250 volts, but the chief point of the secondary emission theory put forward by the writer was that secondary emission took place also at low voltages, e.g., 10 volts.

There are, therefore, two theories for the explanation of these curious kinks. Further experiments, made by keeping the grid and anode potential at a constant ratio, when no increase of "snatching" can take place, have convinced the writer that the secondary emission theory is correct, and that to explain the characteristics more completely we must assume that both grid and anode emit electrons at comparatively low voltages. Also, later writers on the subject, among whom may be mentioned B. van der Pol and E. W. B. Gill, have adopted the secondary emission theory as the basis of their work. The problem will not, however, have received a complete solution until the actual paths of the electrons starting from all three electrodes have been worked out.

Dulwich.

(August 1st-19th.)

Great Britain:—2MZ, 5CT, 6JB, 6LB, 5BY, 2JJ, 6MX, 6UT, 5TT, 6DT, 2BM, 2UX, 2PX, 6ZZ, 5UA, 5RF, 5RW, 2AH, 5OX, 5QM, 6QZ, 5IS, 2ZB, 2OY, 5HC, 2BDQ, 2SX. France:—8GRA, 8GI, 8LI, 8KR, 8SSC, 8LMY, 8WOZ, 8YAN, 8AA, 8YAG, 8CQ, 8SPR, 8LM. Belgium:—K3, V2, F8, Z3, 4KR, R2. Others:—PCUU, N2PZ, SMVL, WIR, WRA, UZZZ, Q4QK. J. C. EDWARDS, (0-v-0)

Burnham-on-Crouch.

British:—2AYP, 2BGO, 2BM, 2KT, (0-v-1.) (All telephony.) 5BW, 5DT, 5HR, 5LS, 5OM, 5QV, 2KV, 2MC, 2MI, 2PX, 2QC, 2QN, 2XR, 5RW, 5UL, 5UO, 5XN, 5ZR, 6HC, 6TX, 6UT. R. C. HORSNELL.

Calls Heard.
Extracts from Readers' Logs.

Bath.

(Sept. 2nd, on 40-60 metres.) Great Britain:—5DH, 6RM. France:—8GJ, 8GP, 8RW, 8HSM, 8TOK, YZ, Y8, Y9, 45CH, 25CH, D6. Holland:—OZA, 2PZ, OGN, PCMM. Belgium:—P2, R2. Italy:—1AY. Unknown:—AIN (calling CNA), OCML, OCTU. (0-v-0, no aerial or earth.) C. W. SALT.

Weybridge.

France:—8AL, 8QQ, 8KL, YZ. Italy:—1AE, 1AY. Holland:—OZA, OGN, PCMM, 2PZ. Belgium:—Z7. Sweden:—SMYV. U.S.A.:—3TR. Unknown:—8LDR, 8FN, 9CH.

R. C. NISBET.

Tashkent, Russia.

Great Britain:—2LZ, 2CC, 2SZ, 2DX, 5SZ, 5BV, 5SI, 6RM, 6KK, 2KF, 6RJ, 2NM, 6TD, 6LO, 6TM, 5NN. France:—8RDI, 8CT, 8FP, 8ALG, 8SSI, 8GI, 8TK, 8BV. Italy:—1RG, 1MT, 1RT, 1MN, 1AV. Sweden:—SMZS. Japan (?):—1AA. Holland:—NOBA, OBQ. Chile:—1EG. Russia:—2DH, 2DS, 6K. U.S.A.:—4RL, UGTT, WIZ, WIR, WQN. Mexico:—1DH. (0-v-2) EXP. STN. NRL, TASHKENT.

VALVE DATA. The particulars given have been compiled essentially from information furnished by the valve manufacturers, though data agreeing within this journal. Valves of British manufacture only have been included. Valves of foreign manufacture are given from time to time under the heading "Valves we have tested."

Table with columns: Type, Filament (Volts, Amps), Anode Volts, Grid Bias Volts, Ma. Emission, Voltage Amplification Factor, Approx. Impedance Ohms, H.F., Detector, L.F., Power Valve, Type, Type, Filament (Volts, Amps), Anode Volts, Grid Bias Volts, Ma. Emission, Voltage Amplification Factor, Approx. Impedance Ohms, H.F., Detector, L.F., Power Valve. The table lists various valve types like M.O., Oscon, Edsman, and B.T.H. with their respective specifications.

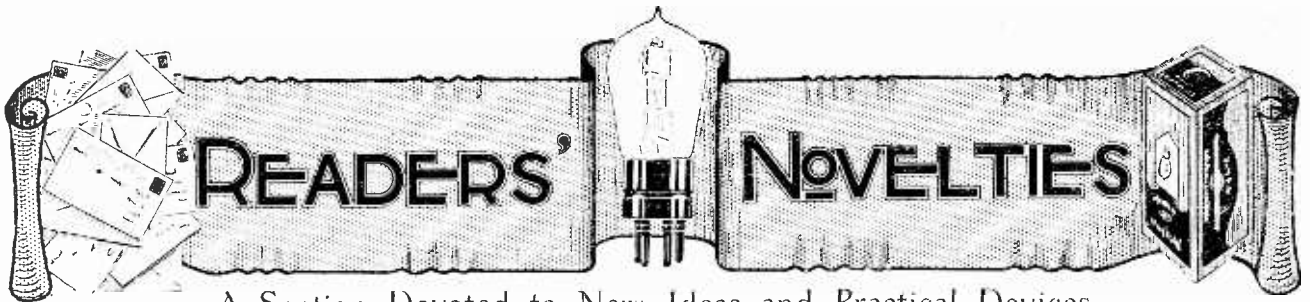

A Section Devoted to New Ideas and Practical Devices.

VERNIER CONDENSER.

A neat mounting for a vernier condenser is shown in the diagram. The condenser plates are screwed to the underside of the receiver panel, which should be preferably of the horizontal type. The moving vane is mounted on the screwed shank of a telephone terminal by means of lock nuts. The terminal passes through a hole in the panel, and is fitted with a spring washer to give the requisite amount of friction. As the lower pair of lock-nuts and the spring washer raise the moving vanes some distance from the panel it will be necessary to insert spacing washers

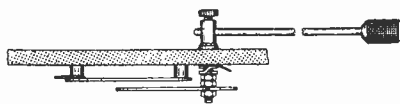
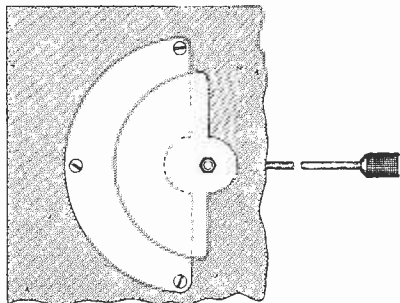

Neat method of adjusting vernier condenser mounted below the panel.

between the fixed vane and the panel in order to reduce the distance between the plates. A soldering tag is inserted between the fixed plate and one of the washers.

It will be seen that the only portion of the condenser appearing above the level of the panel is the terminal head, into which an extension rod may be fitted as shown.—S. P. S.

AERIAL HALYARD.

When a mast is built in more than one section with projecting bolts,

trouble is often experienced through the halyard becoming entangled in the bolts when hauling up the aerial in a wind. If a small curtain ring

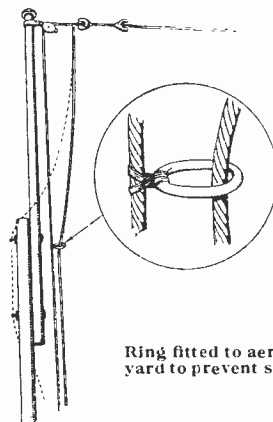

Ring fitted to aerial halyard to prevent swaying.

is fastened to one side of the halyard in the manner indicated in the diagram, the cords will be prevented from separating and a much better control over their movement will be obtained.—J. P. K.

REVERSING REACTION COIL.

A convenient method of reversing the connections of the reaction coil is shown in the diagram. The two set screws on the side of the reaction coil are removed and replaced by two valve sockets, which have been shortened in order that they may not

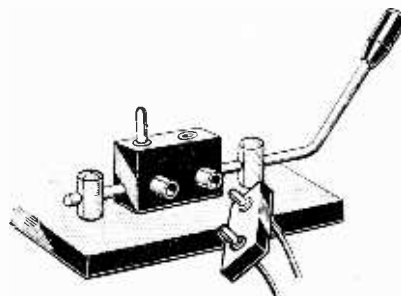

Plug and socket connections for reversing reaction coil.

limit the movement of the coil. The reaction coil leads from the receiver are connected to two valve pins mounted on a short ebonite strip, with a spacing corresponding to the valve sockets. The valve pins are cut short to correspond with the length of the valve sockets; then to reverse the reaction coil it is necessary only to withdraw the pins and reverse their position in the sockets.—T. J. H.

o o o o

ADJUSTABLE COIL HOLDER.

Air-spaced coils for short-wave work vary considerably in width, and if they are to be mounted on

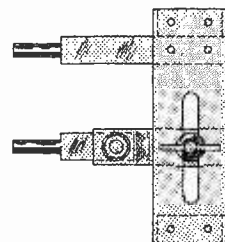
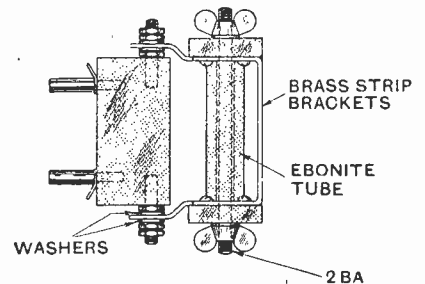

Coil holder that can be adjusted to take coils of various widths.

plugs for coupling in an adjustable coil holder, some provision must be made for this variation in width.

This is most conveniently accomplished by building the coil holder in the form indicated in the diagram. The fixed and moving plugs are mounted between two parallel strips of ebonite spaced apart with brass angle-brackets. The fixed plug is screwed directly between the strips.

For the sake of simplicity this plug has been omitted from the side elevation in the diagram and is only shown in the plan. The moving coil is carried by a brass bracket, the position of which may be varied within the limits of two slots cut in the ebonite strips forming the frame. A length of No. 2 B.A. screwed rod passes through the bracket, which may be fixed in any position by two wing nuts. An ebonite tube takes the strain imposed by the clamping nuts.

Thus the distance between the fixed and variable plugs may be set to accommodate coils of varying width.—T. W.

oooo

HAND DRILL ATTACHMENT.

Many makes of hand drill are provided with a small spirit level fitted for the purpose of keeping the drill horizontal when drilling a panel held vertically in the vice. Unfortunately, drills of this type are expensive and

must be treated carefully if the accuracy of the level is to be maintained. Further, the level gives an indication only in one plane.

A much cheaper and simpler method of obtaining this indication is shown in the diagram. A stiff metal rod is suspended along the side of the drill from a ring screwed into the base of the handle.

A pointer fitted just above the drill chuck indicates when the drill is held vertical, and a retaining ring may be fitted to prevent the rod from swinging out too far.

The scheme is very similar to that employed on chemical balances, and gives a much better indication than the spirit level if the following precautions are taken in fitting the various parts.

The length of the arm supporting the vertical rod measured to the centre of the ring should equal the length of the pointer, the distances in each case being estimated from the axis of the hand drill. Both arms should be

fixed at right angles to the axis of the drill, and should lie in the same plane.

If desired, the pointer may be dispensed with, and the retaining ring used to estimate when the rod is vertical.—V. G. W.

oooo

COMPACT TUNER.

The diagram shows the construction of a neat tuner which can be built up from components to be found in every home constructor's workshop. By using tuning inductances of small dimensions the size of the tuner may be kept quite small and mounted behind the receiver panel.

The A.T.I. is mounted on an ebonite end-plate supported from the panel by two guides. The guides consist of brass rods screwed at each end for locknuts. The reaction coil is mounted on an ebonite strip provided with two holes and mounted between the guides. The movement of the strip is controlled by a No. 6 B.A. or 2 B.A. screwed rod passing through a plain bush in the front of the panel. A similar bush is provided in the centre of the reaction coil strip, and spring washers and locknuts fitted on each side of this bush eliminate "backlash." On the front of the panel is a small lever held against the adjusting screw by means of a short coil spring. The edge in contact with the screw is V-shaped to engage in the thread. For coarse adjustment of the reaction coil this lever is held away from the screw against the pressure of the spring, and the adjusting knob pushed in or out until the approximate coupling required is found.

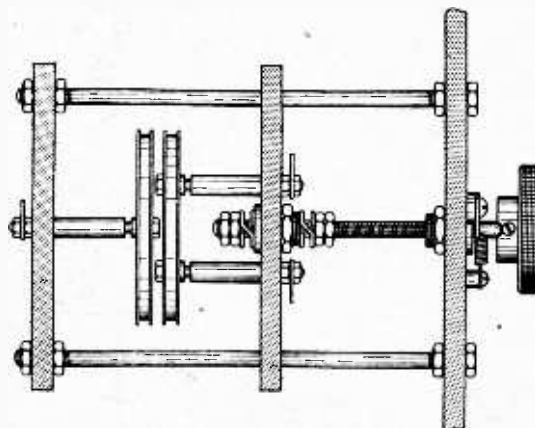
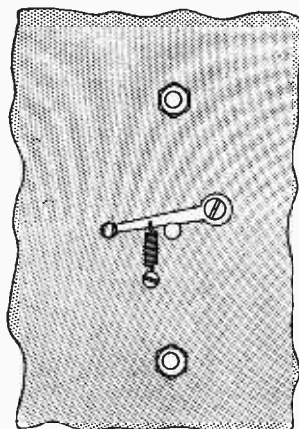

Tuner unit for panel mounting, with coarse and fine adjustment

The lever is then released, when the adjusting screw may be rotated to obtain a final adjustment. The tuning coils are wound in slotted formers similar to those employed for H.F. transformers, and the connections are made through valve pins and-sockets. It will be noticed that in order to obtain as close a coupling as possible, the valve pins on the reaction coil have been placed at right angles to those on the aerial tuning coil.—R. P.

oooo

LOW-LOSS COILS.

The diagram shows a method by means of which low-loss coils may be rapidly mounted for experimental purposes. Ebonite strips of 1/4 in. square cross section are drilled with equally spaced holes of 1/16 in. diameter. The strips are placed along the inside of the turns of the coil

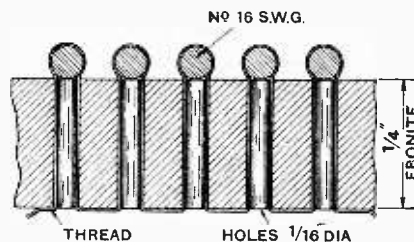

Spacing strip for low-loss coil.

and secured in position by strong thread passing over the outside of the coil at each turn. Three strips fixed in this way should be sufficient to prevent any movement between the turns, which might result in a change of the electrical constants of the coil.—T. P. D.

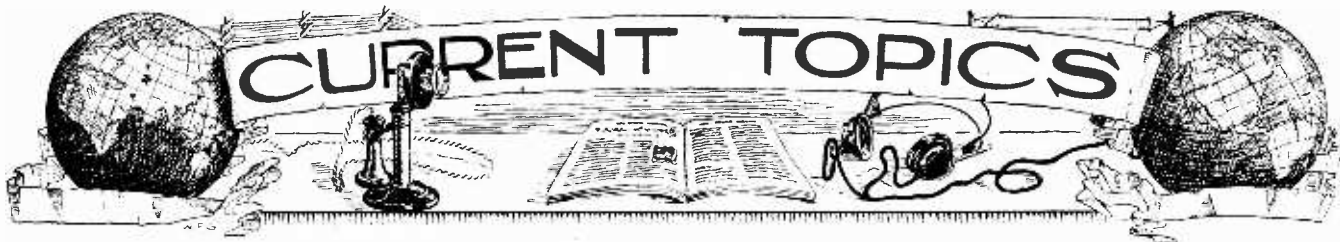

Events of the Week in Brief Review.

MECHANISM OF RADIATION.

Sir Oliver Lodge, in his presidential address before the Radio Society of Great Britain on September 25rd, not only instructed but also entertained an overflow meeting of members.

The subject chosen was "The Mechanism of Radiation," and some original ideas were put forward to stimulate interest in modern theories of radiation, some of which, it was pointed out, it has so far not been found possible to reconcile one with the other.

The full report of the address will appear in our sister journal *Experimental Wireless*, the official organ of the Society.

o o o o

BERLIN RADIO EXHIBITION.

It is reported that more than 200,000 people visited the German Radio Exhibition held in Berlin from September 4th to 13th, and there were a large number of visitors from abroad. The principal centre of attraction was the theatre from whence the Berlin station conducted broadcasting services nightly. Arrangements were made so that the public could watch the actual proceedings in a broadcasting studio.

o o o o

SOUTH AFRICAN BROADCASTING STATION.

The Cape Town station now works on a wavelength of 375 metres, and gives its call-sign as "Cape Town Calling." It is a 6 kw. station, and is run by the Cape Peninsular Broadcasting Association, Ltd.

The Johannesburg station works on 438 metres, with call-sign "J.B." and is a 500-watt transmitter operated by the Associated Scientific and Technical Broadcasting Co., Ltd.

The Durban station on 400 metres, with call-sign "Durban Calling," is a 6 kw. transmitter, and is controlled by the Durban Municipality.

o o o o

RADIO ASSOCIATION.

We are informed that the headquarters of the Radio Association have been moved from Southampton Row to No. 24, Queen Victoria Street, E.C.4.

o o o o

LITHUANIAN WIRELESS.

In accordance with the terms of an agreement concluded with the French firm, Société Française Radio-Électrique, the equipment necessary for a wireless station in Kaunas, Cogo, was to be delivered by June, 1924. In May, 1925, the Lithuanian Government finally fixed a

site for the wireless station in Cogo. There has been some delay, but at the present moment the receiving station is practically ready for use for meteorological services. The transmitting station is undergoing test daily, but certain modifications have yet to be made, so that the station will not be in operation by the specified date, which was September 15th.

o o o o

POPULARITY OF ENGLISH BROADCAST LESSONS.

A report from Vienna states that the teaching of English is rapidly replacing French in secondary schools in Vienna. This increased interest in the English language is specially noticeable in Czechoslovakia and Hungary, and great enthusiasm is displayed in the English lessons which are being conducted by means of the broadcasting stations.

RADIO IN THE PHILIPPINES.

Two rival radio companies in the Philippines have recently come together under the title of "Radio Corporation of the Philippines," and it is expected that this amalgamation will facilitate radio development in the Islands.

o o o o

THE GECOPHONE SUPERHETERODYNE.

In making reference to the superheterodyne receiver of the General Electric Co., Ltd., it has been stated that valves of the D.E.5.B. type are employed in the high-frequency amplifying stages. The standard practice, however, is to employ seven valves of the D.E.3 type, and in the final low-frequency amplifying stage a D.E.4. The total filament current of the set using all eight valves is therefore less than 0.75 amps. By means of interchangeable loading coils the frame aerial provides a tuning range of from 200 to 3,000 metres.

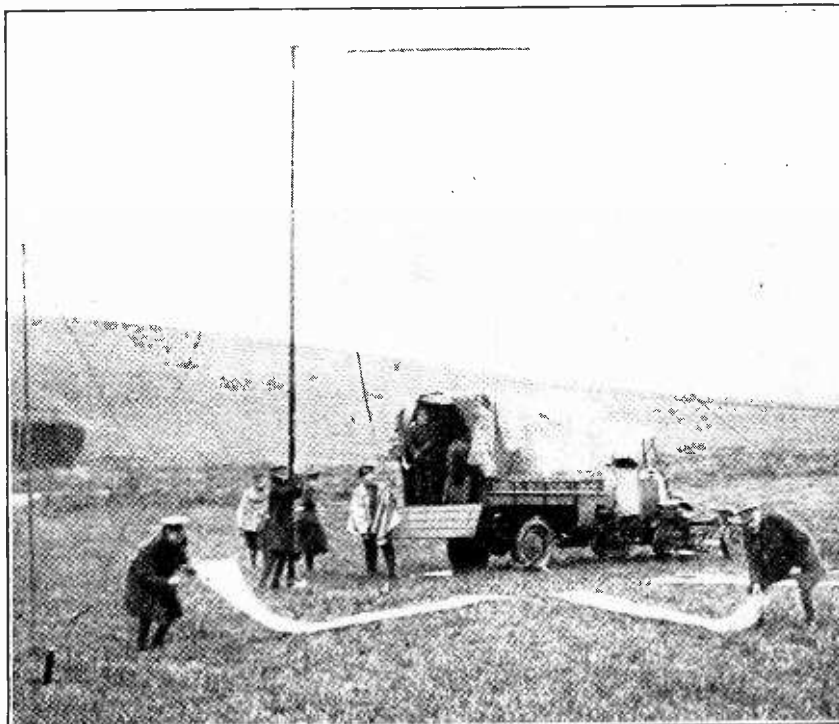

MOBILE WIRELESS. The armies participating in the recent military operations relied principally on wireless as a means of rapid communication. Our photograph shows a signal unit erecting station. Copper mesh mats are used for the earth system, and these are seen in the picture being laid down by the signallers.

VALVES WE HAVE TESTED

THE BURNDEPT SERIES.

MESSRS. BURNDEPT WIRELESS, LTD., the well-known makers of wireless sets and components, have now commenced to manufacture their own valves. A factory has been acquired at Willesden, and is equipped with the most modern machinery and appliances.

Under the direction of Capt. C. F. Trippe, the well-known valve designer, a complete range of receiving valves has been developed, and these made their first public appearance at the N.A.R.M.A.T. Exhibition which has just closed.

The Burndept Nomenclature.

We have had an opportunity of testing sample valves of each type, but, before giving the test results, there are a few points in connection with the nomenclature adopted by the makers which are worthy of comment. Each type is given a number prefixed by a letter. The letter indicates the type. H denotes a high-frequency amplifying or detector valve, L denotes a low-frequency amplifying valve, and H.L. denotes a general-purpose valve.

The figures following represent the normal filament characteristics. The first figure denotes the voltage, and the second and third figures show the current. Thus H.L.565 means a general-purpose valve with a normal filament voltage of 5 and a current of 0.65 ampere. Similarly, L.540 means a L.F. amplifying valve; normal filament volts 5, current 0.4 ampere. All types are fitted with a low capacity base, which incorporates a small ridge indicating the anode pin, and certain types are fitted with the new type of bulb which does away with the sealing-off pip at the top. The finish is such as would be expected from a firm of Messrs. Burndept's standing.

Bright and Dull Emitter Types.

The H.L.565 is the only bright emitter in the series, and its characteristics will be seen to approach very closely to those of the R5V. The anode rating is 40 to 100 volts.

The H.L.512 is a very economical valve for general purpose work. The emission at normal voltage (5.0) is very liberal, and actually in practice the valve may be operated with a much lower filament voltage, which will, of course, tend to increase its

H.L. 565. (Burndept Wireless, Ltd.)

Filament volts, 5.0. Emission (total) 4.95 milliamperes. Filament current, 0.62 ampere. Efficiency 1.6 milliamperes per watt.

Plate Volts.	Plate Current Milliamps. at Zero Grid.	Grid Volts.	Plate Current. Milliamps. ¹	Amplification Factor.	Plate Impedance. Ohms.
40	0.76	0	0.76	10	42,000
60	1.3	-1.5	0.90	10	40,000
80	1.92	-3.0	1.00	10	39,000
100	2.62	-4.5	1.14	10	38,500

¹ Plate current when grid is biased to the value of Col. III.

H.L. 512. (Burndept Wireless, Ltd.)

Filament volts, 5.0. Emission (total) 18 milliamperes. Filament current, 0.12 ampere. Efficiency, 30 milliamperes per watt.

Plate Volts.	Plate Current Milliamps. at Zero Grid.	Grid Volts.	Plate Current. Milliamps. ¹	Amplification Factor.	Plate Impedance. Ohms.
40	1.15	-1.5	0.57	8.3	27,500
60	2.38	-3.0	0.88	8.35	22,200
80	4.1	-4.5	1.2	8.35	19,000
100	5.85	-6.0	1.59	8.35	16,600

¹ Plate current when grid is biased to the value of Col. III.

H. 512. (Burndept Wireless Ltd.)

Filament volts, 5.0. Emission (total) 12.8 milliamperes. Filament current, 0.12 ampere. Efficiency, 21.3 milliamperes per watt.

Plate Volts.	Plate Current Milliamps. at Zero Grid.	Grid Volts.	Plate Current. Milliamps. ¹	Amplification Factor.	Plate Impedance. Ohms.
40	0.28	0	0.28	20.0	67,000
60	0.56	0	0.56	20.0	57,000
80	0.96	-0.5	0.75	19.7	50,000
100	1.49	-1	0.97	18.5	40,000
120	2.16	-1.5	1.23	19.0	35,000
140	2.96	-2	1.58	19.0	32,500

¹ Plate current when grid is biased to the value of Col. III.

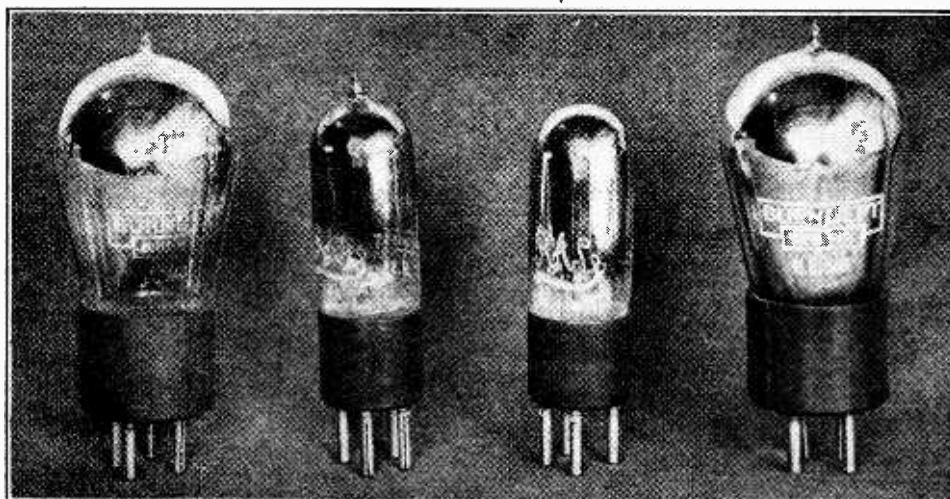

L.240.

H.310.

H.L.310.

H.L.565.

Valves we have Tested.—

life. The electrode construction of this type takes the modern "flattened" form with small inter-electrode clearances. Anode rating, 40-100 volts.

Amplifying Valves.

The H.512 valve is similar in many respects to the H.L.512 but differs in that the amplification factor (and in consequence the plate impedance) has been increased.

The L.525 is a power amplifying valve, and as seen from the table below is capable of dealing with a large input. It is suitable for use in conjunction with H.L.565, H.512, and H.L.512, and will operate from the same low tension battery source. Maximum recommended H.T., 150 volts.

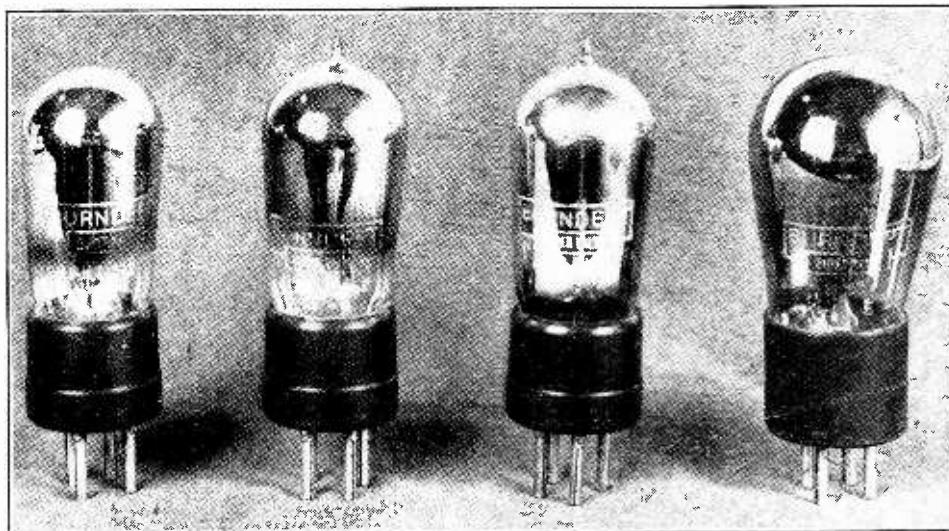

H.L.512.

H.512.

H.L.213

L.525.

H. 310.
(Burndept Wireless, Ltd.)

Filament volts, 3.0
Emission (total) 7.0 milliamperes. Filament current, 0.098.
Efficiency 23.8 milliamperes per watt.

Plate Volts.	Plate Current Milliamps. at Zero Grid.	Grid Volts.	Plate Current Milliamps. ¹	Amplification Factor.	Plate Impedance Ohms.
40	0.28	0	0.28	14.8	87,000
60	0.52	0	0.52	14.8	74,000
80	0.85	- 1	0.6	14.5	65,000
100	1.21	- 2	0.69	14.5	60,000
120	1.62	- 3	0.8	14.5	56,000
140	2.14	- 4	0.92	14.5	55,000

¹ Plate current when grid is biased to the value of Col. III.

H.L. 310.
(Burndept Wireless, Ltd.)

Filament volts, 3.0
Emission (total) 6.8 milliamperes. Filament current, 0.1 amperes.
Efficiency, 22.7 milliamperes per watt.

Plate Volts.	Plate Current Milliamps. at Zero Grid.	Grid Volts.	Plate Current Milliamps. ¹	Amplification Factor.	Plate Impedance Ohms.
40	1.3	- 2	0.8	5.4	25,000
60	2.4	- 4	1.2	5.8	20,000
80	3.5	- 6	1.7	5.8	17,500
100	4.6	- 8	2.7	5.8	16,500

¹ Plate current when grid is biased to the value of Col. III.

L. 243.
(Burndept Wireless, Ltd.)

Filament volts, 2.0.
Emission (total) 18.0 milliamperes. Filament current, 0.41.
Efficiency, 21.9 milliamperes per watt.

Plate Volts.	Plate Current Milliamps. at Zero Grid.	Grid Volts.	Plate Current Milliamps. ¹	Amplification Factor.	Plate Impedance Ohms.
60	4.72	- 3	3.07	4.7	9,300
80	7.4	- 6	3.75	4.85	8,900
100	10.15	- 9	4.25	4.85	8,700
120	13.00	- 12	5.00	4.85	8,000

¹ Plate current when grid is biased to the value of Col. III.

This is a useful general purpose valve with a low filament consumption. Plate voltage rating, 40-100.

The "310" variety is intended for use with either an accumulator or dry cell filament battery, and it is noteworthy that a plate voltage up to 140 may be employed.

Under practical working conditions all the aforementioned types gave excellent results, and the values of plate and grid voltages given in the tables form a useful guide for operating these valves. The Burndept range can, with confidence, be recommended.

The L.240 is a small power amplifying valve and may be used in conjunction with the H.L.213. 120 volts is the maximum plate voltage recommended.

L. 525.

(Burndept Wireless, Ltd.)

Filament volts, 5.0.
Emission (total) 22.5 milliamperes. Filament current, 0.25 ampere.
Efficiency, 18 milliamperes per watt.

Plate Volts.	Plate Current Milliamps. at Zero Grid.	Grid Volts.	Plate Current Milliamps. ¹	Amplification Factor.	Plate Impedance Ohms.
80	7.45	- 6	3.0	5.15	8,600
100	10.2	- 8	4.15	5.55	8,500
120	12.92	- 10	5.15	5.8	8,500
140	15.77	- 12	6.2	5.8	8,450

¹ Plate current when grid is biased to the value of Col. III.

H.L. 213.

(Burndept Wireless, Ltd.)

Filament volts, 2.0.
Emission (total) 5.6 milliamperes. Filament current, 0.12 ampere.
Efficiency, 23.3 milliamperes per watt.

Plate Volts.	Plate Current Milliamps. at Zero Grid.	Grid Volts.	Plate Current Milliamps. ¹	Amplification Factor.	Plate Impedance Ohms.
40	0.71	0	0.71	8.7	32,500
60	1.4	- 1.5	0.93	8.7	30,000
80	2.15	- 3	1.16	8.75	28,500
100	2.91	- 5	1.25	8.75	26,500

¹ Plate current when grid is biased to the value of Col. III.

NEWS FROM THE CLUBS

Secretaries of Local Clubs are invited to send in for publication club news of general interest.

All photographs published will be paid for.

Stretford and District Radio Society.

A society with the above name has just been formed in the Stretford district of Manchester. Every effort is being made to build up a large membership for the winter session, and all interested in wireless are warmly welcomed. Applications for membership should be addressed to the Hon. Secretary (*pro tem.*), Mr. Wm. Hardingham, 21, Burleigh Street, Stretford, Manchester.

o o o o

The Scientific Research Society.

At a recent meeting Mr. J. V. Newson gave a lecture and demonstration on "X Rays." The lecturer dealt with the discovery of the rays and the means of producing them, afterwards dwelling on the subject of fluorescent screens. He gave simple directions for making effective screens at a very small cost. The demonstration was very successful, and was much appreciated. The induction coil used was kindly loaned by the engineer, Mr. R. M. Dougan.

Applications for membership are invited from those interested in scientific subjects. Letters should be addressed to the honorary secretary, Mr. J. V. Newson, at 139, Ormside Street, London, S.E.15.

o o o o

Kensington Radio Society.

The lecturer for the September monthly meeting of the above Society was Mr. A. E. J. Symonds. He gave a most interesting lecture, entitled "The High-Power Transmitter at Northolt," which was illustrated with lantern slides and was much enjoyed by all present. A hearty vote of thanks was accorded Mr. Symonds for the pains he had taken to lucidly explain minor details in the inner working of one of our most powerful Government high-power stations.

Hon. secretary: Herbert Johnson, 36, Cromwell Rd., Wimbledon, S.W.19.

o o o o

Bolton and District Radio Society.

A grand lantern lecture will be given on Wednesday, October 14th, 1925, in the Y.M.C.A. Buildings, Deansgate, Bolton, by Mr. H. A. Hankey, assistant engineer of the B.B.C., London. Subject: "Radio Ramifications." His Worship the Mayor of Bolton (Councillor J. F. Steele, J.P.) will preside, and Mr. Victor Smythe ("Uncle Victor" of 2ZY) will be present in support. Commences at 7.30 p.m. Hon. secretary, Mr. J. Grimshaw, 70, Church Road, Bolton.

I.E.E. Wireless Section.

The dates announced for meetings of the wireless section of the I.E.E. are as follow:—1925, November 4th, December 2nd; 1926, January 6th, February 3rd, March 3rd, April 14th, May 5th.

o o o o

Leyton Radio Association.

The Leyton Radio Association commences its winter programme to-day, September 30th, with a lecture entitled "Cutting Out the Local Station and Long-distance Reception," by Mr. H. L. Kirke, a senior engineer of the British Broadcasting Company.

The meeting will commence at 8 p.m., and will be held at the above association's headquarters at the National Schools (High Road Schools), High Road, Leyton, E.10. All radio enthusiasts invited.

The Leyton Radio Association meets at headquarters every Wednesday at 8 p.m., and new members will be heartily welcomed. Hon. secretary, 102, Goldsmith Road, Leyton, E.10.

o o o o

The Camden Town and District Radio Society.

The above radio society is commencing next Monday a second-year course of instruction in general science and radio.

Elementary classes are held on Mondays (7.45 to 9.45). Second-year, transmission and Morse, on Fridays (7.45 to 9.45). A class is also being formed for a "maths." class, with special reference to wireless.

Building of sets and practical work of every description are being carried out each evening under expert supervision. Instructor and lecturer: Mr. Ralph Judson, Graduate I.E.E.

You can join the society at any time, fee 1s. per quarter.

Headquarters, Carlton Road, N.W.5 (I.C.C. Men's Evening Institute).

o o o o

Inland Revenue Radio Society.

The above society will hold its first meeting of the season at 6 p.m. on Friday, October 2nd, at 2, South Place, E.C.2. The president, Mr. H. A. Stevens, will address the members, and a lecture, entitled "H.T. and L.T. from D.C. Mains," will be given by the chairman, Mr. W. S. Best.

An attractive programme has been arranged, including lectures, etc., by well-known manufacturers.

The society is open to all members of the Department, and particulars of membership are obtainable from the hon. secretary, Mr. W. J. Tarring (G5TG), Room C2, York House, Kingsway, W.C.2.

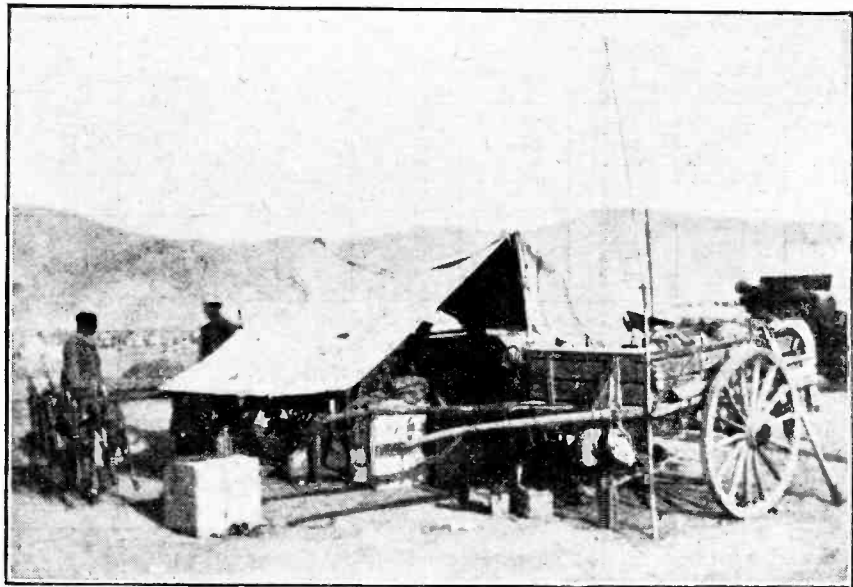

RADIO IN THE RIFF CAMPAIGN. One of the first photographs taken in action of a Wireless section of the French Colonial Artillery. Taking firing instructions from an advanced post.

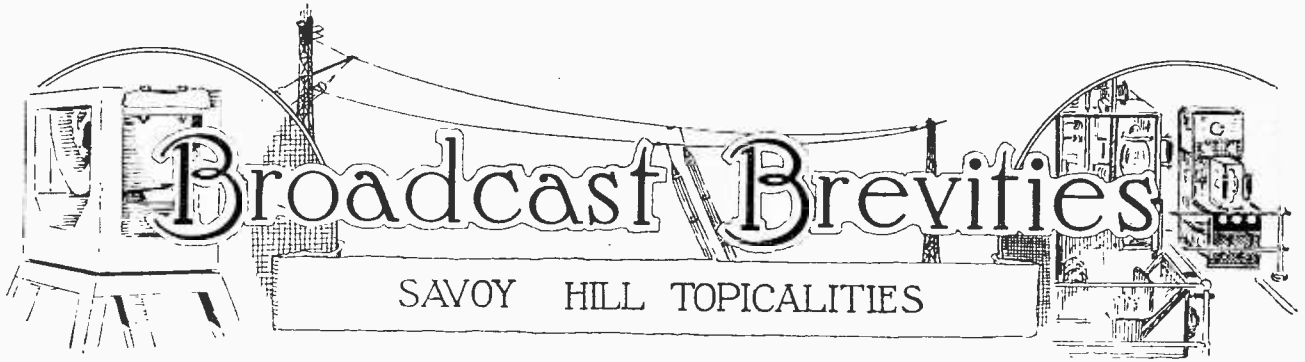

SAVOY HILL TOPICALITIES

Distinct Improvements.

Throughout the tests the Geneva Broadcasting Bureau was in constant touch with all European stations and the improvements effected on its recommendations are shown by the fact that during the first and second tests five British stations were definitely heterodyned; during the third test the number dropped to four; during the fourth test, to two; during the fifth test, to one; while on the occasion of the final test no British stations were definitely heterodyned.

o o o o

Foreign Stations.

The outstanding feature of the tests was the difficulty experienced by stations in turning over from the programme to the exact test measurement of wavelength. Bournemouth, for example, was altered by one metre on one occasion to avoid heterodyning and was found to be heterodyned on another station. The situation as regards the Spanish stations which, by the way, is likely to be a com-

plicated one, was accentuated by the fact that San Sebastian was testing during the later stages. Its wavelength was given out as 346 metres. San Sebastian is a 3 kW. station and its wavelength was within one metre of Petit Parisien's wavelength for the tests. The result was that Petit Parisien was forced to change its wavelength.

o o o o

Wavelength Tests.

The Geneva representatives at the British Conference of Broadcasters which was held a few days ago, presented a summary of the results obtained during

Test.	British Stations Definitely Heterodyned.	British Stations Slightly Heterodyned.	British Stations Clear.	Foreign Stations Clear.
1	6BM, 2EH, 5SC, 6KH, 6LV (five).	—	15	—
2	2BE, 6BM, 2EH, 6KH, 2ZY (five).	6SC, 5NO (two).	13	—
3	6BM, 2LS, 5WA, 5NO (four)	—	16	—
4	2LS, 6BM (two)	5IT, 5NO, 2BE, 6SC (four).	14	6
5	2LS (one).	5WA (one)	18	8
6	None.	5PY, 2LO, 5WA, 2LS (four).	16	—

the tests early in September. This summary is given in the table below.

o o o o

Continental Programmes.

Experiments are now being made at Hayes in picking up the programmes of the chief Continental broadcasting stations, and a selection of the best of these is being made. The stations concerned will, within the next few days, be asked to participate directly in the "Round the Continent" programme which the B.B.C. contemplates putting out to listeners in this country on October 15th.

Special Broadcasts.

On various nights of the week it has been the custom to introduce a special feature at 10.15 from all stations. This feature is being developed, and the following list of "stars" will broadcast during the first fortnight of October:—
Saturday, October 3rd.—Melville Gideon, from "The Co-Optimists."
Monday, October 5th.—Daisy Kennedy, the Australian violinist.
Tuesday, October 6th.—Norah Blaney and Gwen Farrar.
Wednesday, October 7th.—Jack Buchanan from popular revues.
Friday, October 9th.—Arthur Wimperis.
Monday, October 12th.—Max Darewski, the pianist and composer.
Tuesday, October 13th.—Ella Shields, the music-hall star.

With the exception of Messrs. Wimperis, Gideon, and Darewski, these artists will be giving farewell performances prior to leaving this country for tours or engagements in America and elsewhere. The "features" will be broadcast after the second news, and are mostly timed for 10.30 p.m.

o o o o

Apparatus at Hayes.

Reference was made recently in this page to the apparatus to be installed at the new receiving station at Hayes, a

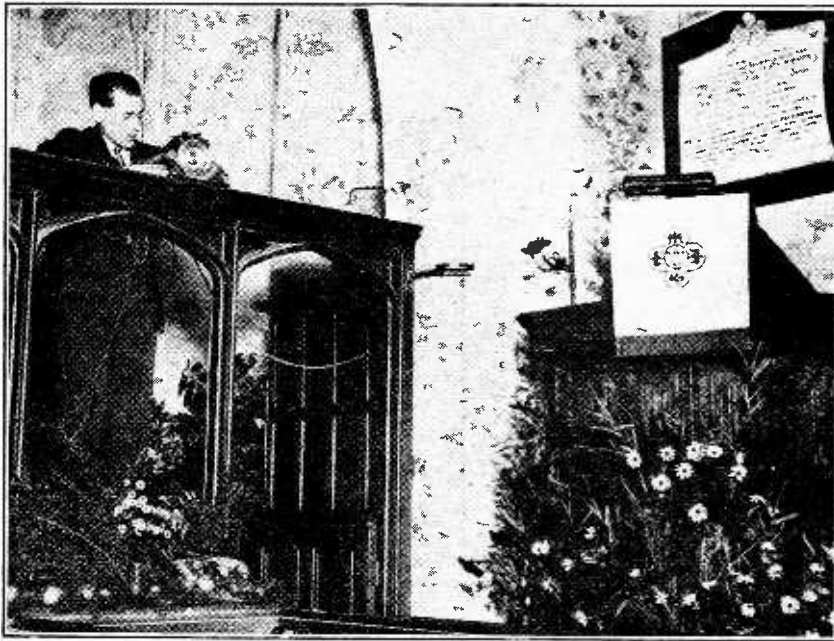

HARVEST FESTIVAL BROADCAST. An Engineer of the B.B.C. arranging the microphone near the pulpit of the Stoke Poges Church for the Harvest Thanksgiving service, which was recently broadcast.

feature of which was the erection of masts about five feet in height for directional reception. Pending the development of schemes for the exchange of programmes with the Continental stations, the engineers will be content to use two masts, each sixty feet high and 120 feet apart, but broomstick aeriols will be put up as soon as the occasion warrants. The D.F. apparatus, an expensive item in itself, also will not be installed at present, and as its purpose will be to trace interference the engineers have decided to await the decisions of the Geneva Conference before proceeding with the installation of the apparatus.

o o o o

Birmingham Station.

The new transmitter at the Birmingham station has now been working long enough to satisfy the engineers that in some respects it is superior to the old apparatus. Reports of improved reception have been received from many listeners; and practically all state that the signals are stronger and purer. Because of its central situation, Birmingham is a very popular station. In favourable conditions it is probably the easiest of all British main stations to pick up from a distance.

o o o o

The Apparatus.

The new transmitter is working on a power of 1 kW. in the aerial; but although this is equivalent to double the old power and is capable of further increase, it does not mean that the signals which go out from the aerial are twice as loud in and around Birmingham, although people further away from the station are getting considerable benefit in this respect. An interesting feature of the new transmitter is that it employs a water-cooled valve as a high-frequency amplifier. The high power station at Daventry is the only other broadcasting station in England to use water-cooled valves. Listeners would be doing good service to the B.B.C. if they would send in reports on their experience in receiving the Birmingham programmes, and particularly if they would furnish comparisons of reception between the new and the old transmitter, so that the engineers can make whatever adjustments are necessary.

o o o o

International Broadcasting.

Although the transmissions of the speeches of M. Painlevé and Mr. Austen Chamberlain at the opening of the League of Nations Conference were on the whole disappointing, subsequent experiments in international broadcasting have been much more encouraging. One night recently, for instance, the B.B.C. was asked to provide successive half-hour relays from London, Birmingham, and Aberdeen. Items from the programmes of these stations were, therefore, sent by land-line to London, where they were transferred to the trunks switchboard and relayed to PTT (Paris), by whom they were again relayed to PTT (Toulouse), and there broadcast, the reception in this country being distinctly good.

B 26

FUTURE FEATURES.

Sunday, October 4th.

LONDON.—9 p.m., The London Chamber Orchestra.

BIRMINGHAM.—4 p.m., Evensong relayed from Worcester Cathedral.

Monday, October 5th.

ALL STATIONS (except Newcastle and Glasgow).—8 p.m., "Carmen," Acts II. and III. Performed by the British National Opera Company. Relayed from the Theatre Royal, Glasgow.

LONDON.—10.30 p.m., A Farewell Violin Recital by Daisy Kennedy.

Tuesday, October 6th.

5XX.—9.30 p.m., Music to "Don Quixote," Part II., relayed from Covent Garden.

LONDON.—9 p.m., Reminiscences of the Old Music Hall.

Wednesday, October 7th.

ALL STATIONS.—10.30 p.m., Jack Buchanan in Recent Revue Successes.

LONDON.—8 p.m., Ballet Music Programme followed by the Offenbach Follies.

BIRMINGHAM.—8 p.m., An Hour of Russian Music and an Hour with British Composers.

LIVERPOOL.—8 p.m., Cunard Company's Concert, relayed from s.s. Franconia.

Thursday, October 8th.

LONDON.—8.30 p.m., "Tosca," Act. II. Performed by the British National Opera Company. Relayed from the Theatre Royal, Glasgow. S.B. to other Stations.

ABERDEEN.—8 p.m., Pianoforte Recital by Lefi Pouishnoff.

Friday, October 9th.

5XX.—8.15 p.m., Music of "The Fairy Doll," relayed from Covent Garden.

BIRMINGHAM.—8 p.m., Light Glassical Programme.

CARDIFF.—9.15 p.m., "Radio Radiance" Revue.

MANCHESTER.—8 p.m., Symphony Concert.

GLASGOW.—8 p.m., Scenes from "Peer Gynt," a Fantasy by Ibsen. Music by Grieg.

BELFAST.—7.30 p.m., "Shamrock"—An Irish Evening.

LIVERPOOL AND 5XX.—9.30 p.m., "The Revenge" (Stanford).

Saturday, October 10th.

LONDON.—9.15 p.m., "Radio Radiance" Revue (7th Edition).

CARDIFF AND 5XX.—7.30 p.m., Popular Concert relayed from the Town Hall, Pontypridd: The Band of H.M. Royal Air Force.

ABERDEEN.—8 p.m., 2nd Birthday Programme.

The Pavlova Ballet.

Arrangements are being made to broadcast extracts from the Pavlova ballet music at Covent Garden during their four weeks season. The first extract was given on Monday last (September 28th), and the remainder will be as follows:—

Wednesday, September 30th.—"A Polish Wedding," 8.15-9.5 p.m.—5XX.

Tuesday, October 6th.—"Don Quixote," 9.30-10.0 p.m.—5XX.

Friday, October 9th.—"The Fairy Doll," 8.15-8.55 p.m.—5XX.

Wednesday, October 14th.—"The Sleeping Beauty," 8.15-9.0 p.m.—5XX.

Monday, October 19th.—"Russian Folk Lore," 8.15-9.15 p.m.—2LO and 5XX.

Friday, October 23rd.—"Chopiniana," 8.15-8.55 p.m.—2LO and 5XX.

Saturday, October 24th.—"Divertissement" (final performance of Season), 10.30 p.m.—S.B.

o o o o

Longer Daventry Programmes.

The usefulness of Daventry will be increased in the near future by an extension of the hours of broadcasting. It is a momentous undertaking to formulate a scheme of continuous broadcasting from the Time Signal and Weather Forecast at 10.30 in the morning right on until 11 or 11.30 at night, as it takes half-an-hour to get the transmitter at 5XX started up to see if it is working satisfactorily. If a system of continuous broadcasting were adopted, it would mean that the station would actually be working from 10 o'clock in the morning until nearly midnight, and a special shift of engineers would be required for maintenance work. Further, if 5XX were working for fourteen hours at a stretch every day in the week, the liability of the apparatus would be considerably increased and much additional expenditure consequently involved.

o o o o

Beneficial Effects.

As, however, an extension of Daventry's hours will be to the benefit of a large body of listeners, including night workers who are debarred from listening during the evening, some extension of hours will be introduced at once, and 5XX will be transmitting as from October 3rd at 11 a.m. to 2 p.m., in addition to the usual afternoon and evening services. This arrangement will continue for one month as an experiment, when the position will be reviewed from the engineers' point of view.

o o o o

Studio Acoustics.

Experiments are continuing with the acoustical effects in studios in order to obtain a kind of stereoscopic effect, that is, to concentrate sounds made in different parts of the studio on to a central point, as represented by the microphone. An attempt is to be made to obtain the desired effect by placing the microphone in a hole in the wall so as to present the distribution of sound behind the apparatus.

V ALVES in the MAKING.

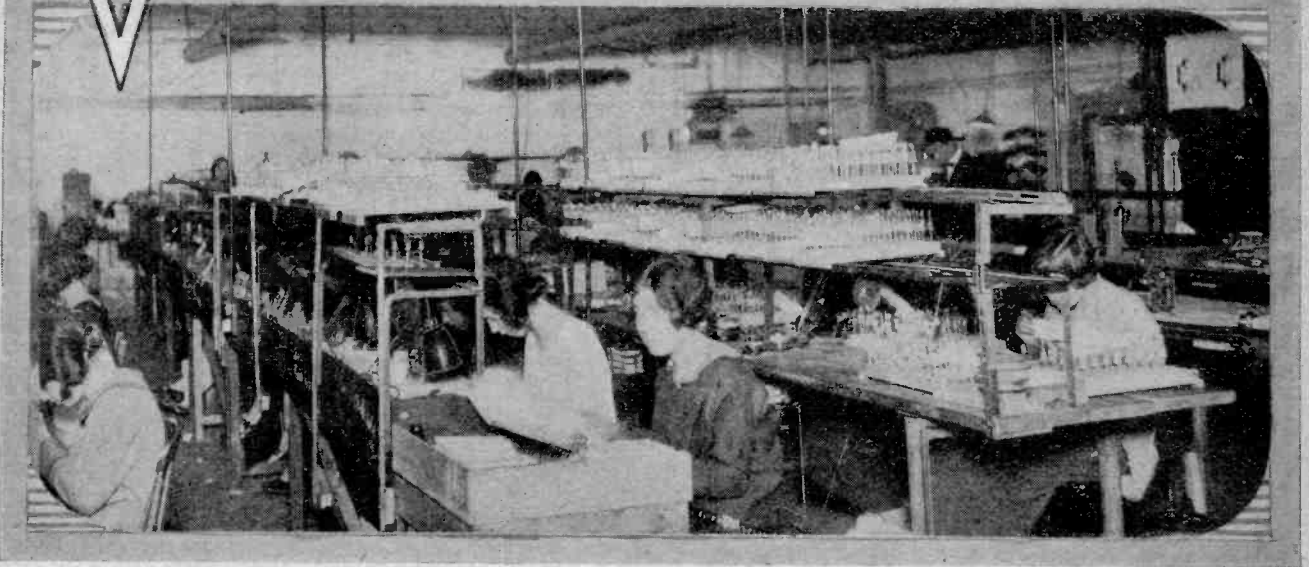

General view of the Assembly Room at the Mullard Valve Works.

A Description of the Manufacturing Methods Employed at Three Representative Valve Factories.

By W. JAMES.

AT the present time there are being manufactured on a large scale at least three different classes of valves. Until comparatively recently the best known of these was the *bright emitter*, but to-day the valves most frequently used in wireless receivers are of the *dull emitter* type.

The filament of the bright emitter is usually a tungsten wire and has to be heated to a high temperature before it emits a useful quantity of electrons. Valves of the dull emitter class, on the other hand, have a treated filament and are characterised by their ability to emit a plentiful supply of electrons at relatively low temperatures.

There are two general kinds of dull emitter filaments. One kind consists of a core with a coating of active material, a particular filament often used being of strip platinum alloy coated with a mixture of the oxides of calcium, barium, and strontium. This filament is worked at a dull red heat. The second type of dull emitter has a thoriated tungsten filament. As valves with a thoriated filament are so widely used, it will be well to consider a little more fully the peculiarities of this form of filament when the reasons for the elaborate manufacturing processes will the more readily be understood.

Soon after the tungsten filament was first used in electric lamps, it was found that a more robust filament was obtained if the tungsten had a small proportion of other substances—and particularly thoria—mixed with it (thoria being the oxide of the metal thorium). When thoriated tungsten filaments were used in valves, it was discovered that the emission could be made much larger than usual by a suitable heat treat-

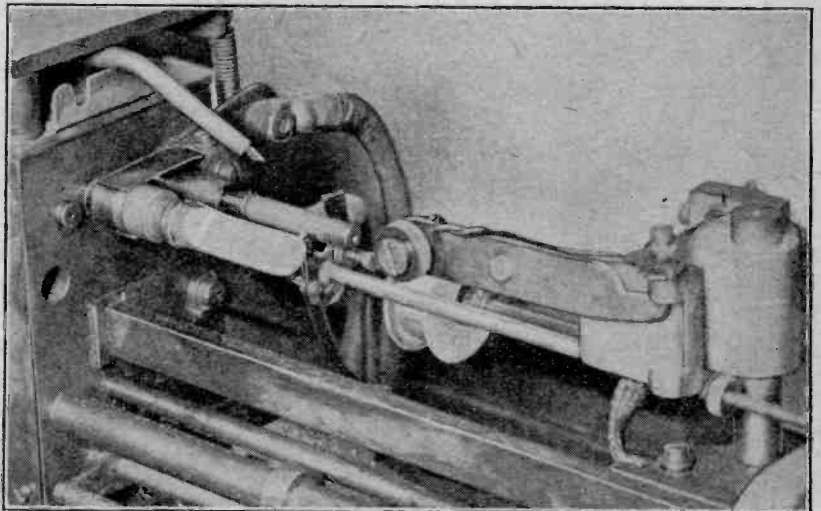

Fig. 1.—Machine for winding grids of the oval type used at the Osram Works. The grid, which has been completed, is for a DE 5 valve.

Valves in the Making.—

ment, and that then the filament would emit the same number of electrons as a tungsten filament when at a considerably lower temperature.

This heat treatment consists in first burning the filament at a temperature of about 2,900° K. for a minute,

The effect of the heat treatment is to produce a chemical reaction between the thoria and tungsten which produces thorium. This thorium diffuses outward from the interior of the filament, and forms a film or layer on the surface, after which the emission obtained is that characteristic of thorium instead of tungsten. Further, the film of thorium on the surface of the filament is maintained while working the valve at its normal temperature.

The advantages of a thoriated filament cannot be fully utilised unless the degree of vacuum of the valve is extremely high. Thorium emits electrons so freely at a low temperature because it is much more electro positive than tungsten, and it tends to turn to thoria in the presence of

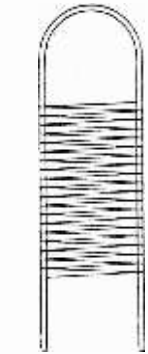

Fig. 2.—View of a grid for a DE 5 valve as taken from the machine of Fig. 1.

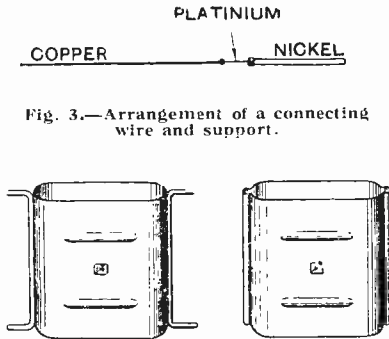

Fig. 3.—Arrangement of a connecting wire and support.

Fig. 4.—Two forms of anode for valves of the 5-volt 0.25 ampere class.

and then at 2,250° K. for three or four minutes. The emission was then found to be perfectly steady when the filament was heated to 1,700° or 1,800° K., which is the working temperature. If the temperature was increased to, say, 2,500° K., the emission was found to rapidly decrease, until only the emission characteristic of tungsten was obtained. By reducing the temperature again to 2,250° K., it was found that the emission was completely restored.¹

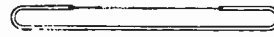
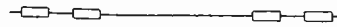

Fig. 5.—Method of mounting a 60mA filament before fitting it to the filament supports used at the Osram Works.



Method adopted at the Mullard Works.

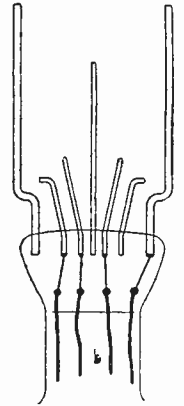

Fig. 6.—Arrangement of the supports and connecting wires in the foot of a valve of the 5-volt 0.25 ampere class.

minute traces of suitable gases. It is therefore not possible to activate a dull emitter filament unless very great care has been taken to produce and maintain a very good vacuum. Efficient pumps are, of course, employed to exhaust the valve, but this is not enough.

The metal supports and electrodes, as well as the bulb of the valve, contain occluded gas, and steps have therefore to be taken during manufacture to remove as much of this gas as possible, to ensure that during the life of the valve no harmful quantity shall be released. The electrodes are therefore heated during the evacuation process.

Apart from the mere mechanical work of constructing the elements and mounting them in suitable positions, it can easily be seen that extraordinary precautions have to be taken to produce a very hard valve—a valve, in fact, which is exhausted to a higher degree than hard valves of the well-known bright emitter type.

The production of a valve may therefore be divided into several separate and distinct sections, and as a result of visits to the factories of the leading valve manufacturers the writer would divide up the work as follows:—

- (a) Preparation of the connecting wires and supports, (b) construction of the

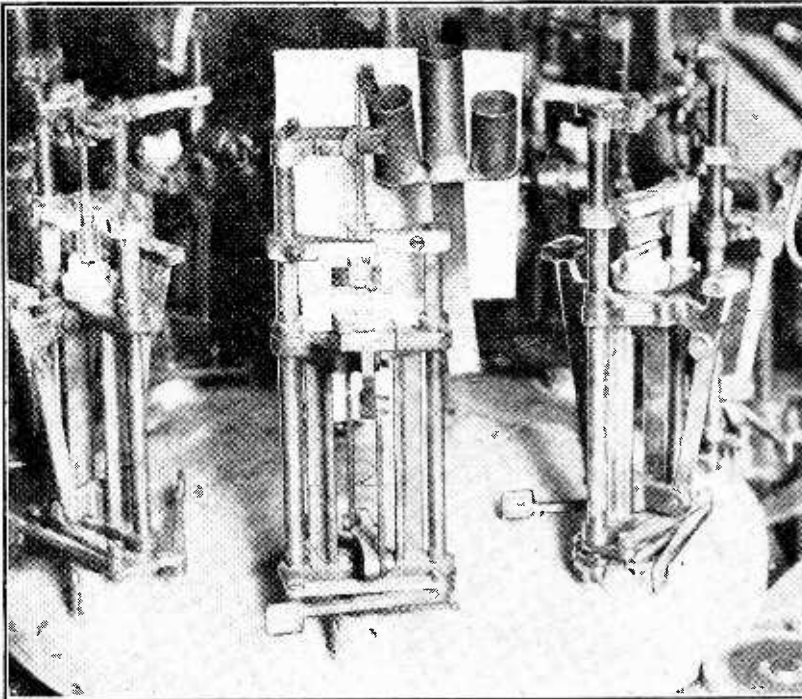

Fig. 7.—Machine at the Osram Works for shaping the glass foot and sealing the wires and supports

¹ "Thermionic Valves with Dull-emitter Filaments," by Thompson and Bartlett, Journal I.E.E., April 2nd, 1924.

Valves in the Making.—

grids and anodes, (c) assembly of connecting wires in foot (d) assembly of the electrodes, (e) the fitting of the bulb, (f) pumping and sealing, (g) the getter process, (h) heat treatment, (i) ageing, (j) fitting base, (k) testing, (l) marking and packing. The work is not necessarily carried through in this order by all manufacturers, and the method of dealing with the various types of valves is different, but from this list of division the reader will have a general idea of how the work is proceeded with.

Wires and Supports.

If the reader will look at the glass foot of a power valve (5 volts 0.25 ampere type), he will see sticking out of the top of the pinch two stiff wires for the filament, two for the grid, and two thicker wires for the anode (Fig. 6). He will also see four fine wires connected to four of the supports and four more wires which are connected to the valve pins. The stiff supporting wires are of nickel. The finer wires which are buried in the glass pinch are of red platinum or platinum substitute, while the lower (connecting) wires are of copper.

The reasons for the employment of the nickel and copper wires are obvious, while the platinum wires are used to enable a good air-tight seal to be made and maintained during the operation of a valve. The various wires are joined by electric welding, and appear when first made somewhat as sketched in Fig. 3.

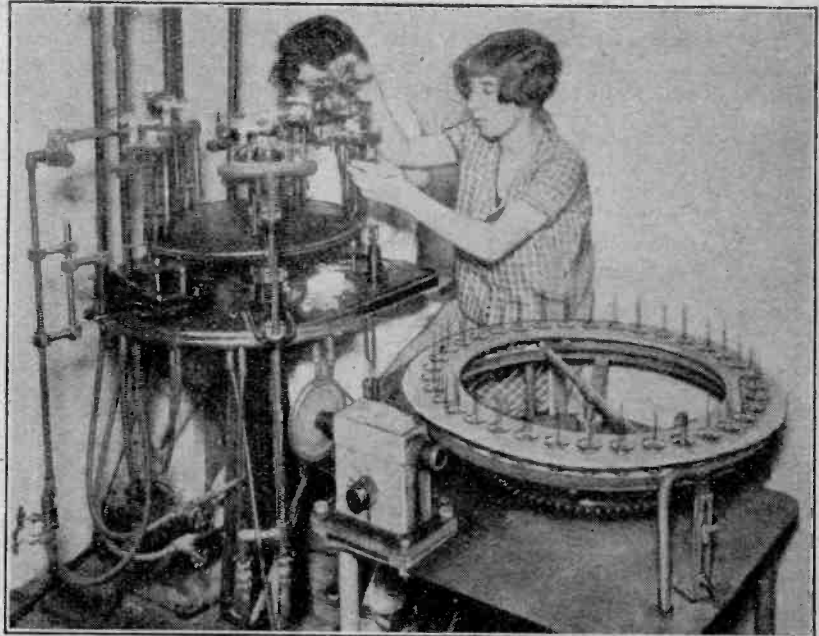

Fig. 8.—Another machine for shaping the foot and sealing the wires. (Mullard Works.)

Nickel wire of various gauges is used, depending, of course, on the size of the electrodes of the valve and the particular arrangement of the electrodes adopted. To support the anode and grid of a power valve of the 5 volts 0.25 ampere type, thick wires are used, while in smaller valves, such as the 60 milliamper class, only four wires may be provided to support the anode, grid, and filament. The procedure, however, is the same in each case, the wires of copper, platinum, and nickel, being cut into suitable lengths and then welded together to form straight pieces, as sketched in Fig. 3.

Grids and Anodes.

The grids and anodes of the smaller valves are usually circular in cross-section, while those used in power valves are oval or rectangular. Grids of the circular cross-section type are usually wound by the yard by running nickel wire over a metal former threaded to the correct pitch. Suitable lengths are cut off, and a length is then put in a jig, a stiff nickel wire laid along it, and the point of contact of the turns with the straight wire welded.

Each turn is, therefore, securely fixed to the supporting wire with the aid of only the very simplest of tools. Grids of precisely the right

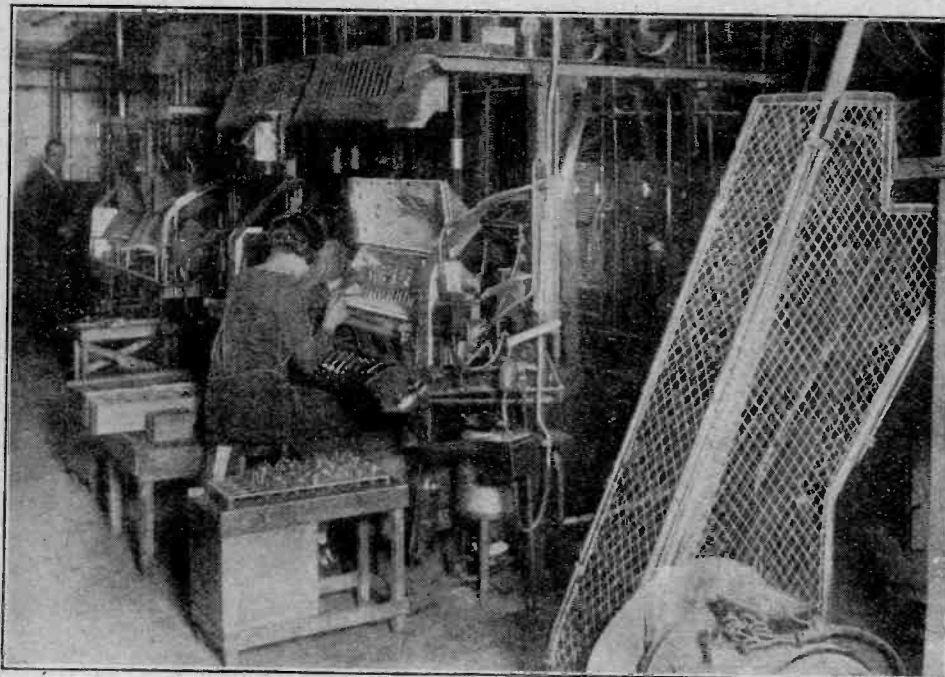

Fig. 9.—Sealing the valves to the pump at the Mullard Works.

Valves in the Making.—

diameter, spacing, and number of turns, are thus easily produced.

Grids of oval cross section for use in power valves are

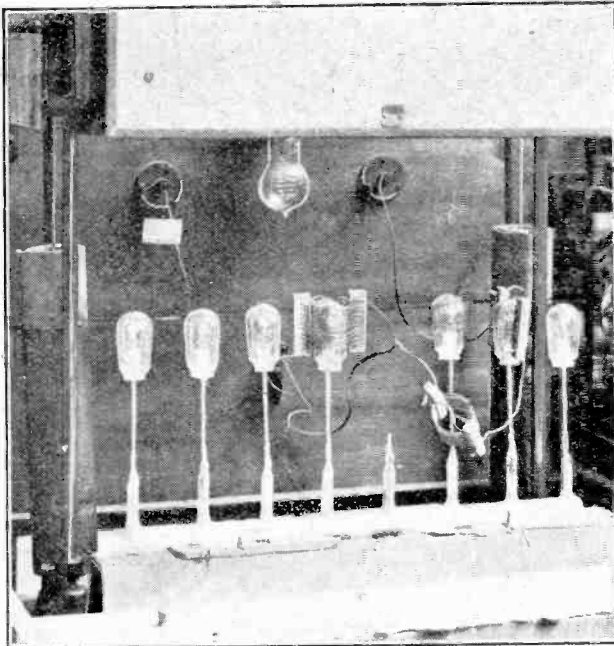

Fig. 10.—Valves on the pump at the Osram Works. The coils carrying high frequency currents are used to heat the elements and flash the magnesium.

wound on a support of stiff wire. The wire is bent to a U shape, as seen in Fig. 1 and Fig. 2, and put in a machine. One end of the grid wire is then welded in position and the grid wire is wound on, and the turns welded to the supports.

Machine Wound Grids.

A machine for winding grids of this type is illustrated in Fig. 1. The former upon which the grid is wound can be clearly seen, whilst just at the back of it is the threaded rod which guides the grid wire and so spaces the turns by the right amount. The arm with the shaped end seen on the left-hand side can be moved into a slot just above the mandrel carrying the grid former, and is used to weld the first turn of the grid wire to the support. When the grid is wound, the turns are welded to the support by passing the arm carrying the wheel, seen

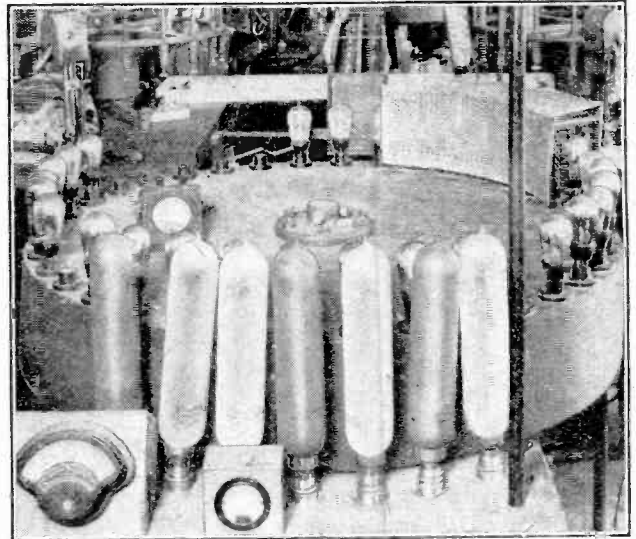

Fig. 11.—A machine for "gettering" valves. It will be noticed that the valves at the back are clear, while those leaving the tunnel have been gettered and have the characteristic silvery appearance. (Osram Works).

on the right-hand side, first along one edge and then the other edge of the grid.

For the anodes of the valves, pieces of rectangular or other suitable shape are stamped out of sheet nickel. These pieces are then rolled or stamped to the correct shape, after which some types have supporting wires fitted to them. An anode of this type is sketched in Fig. 4. In another type, also Fig. 4, the anode is made

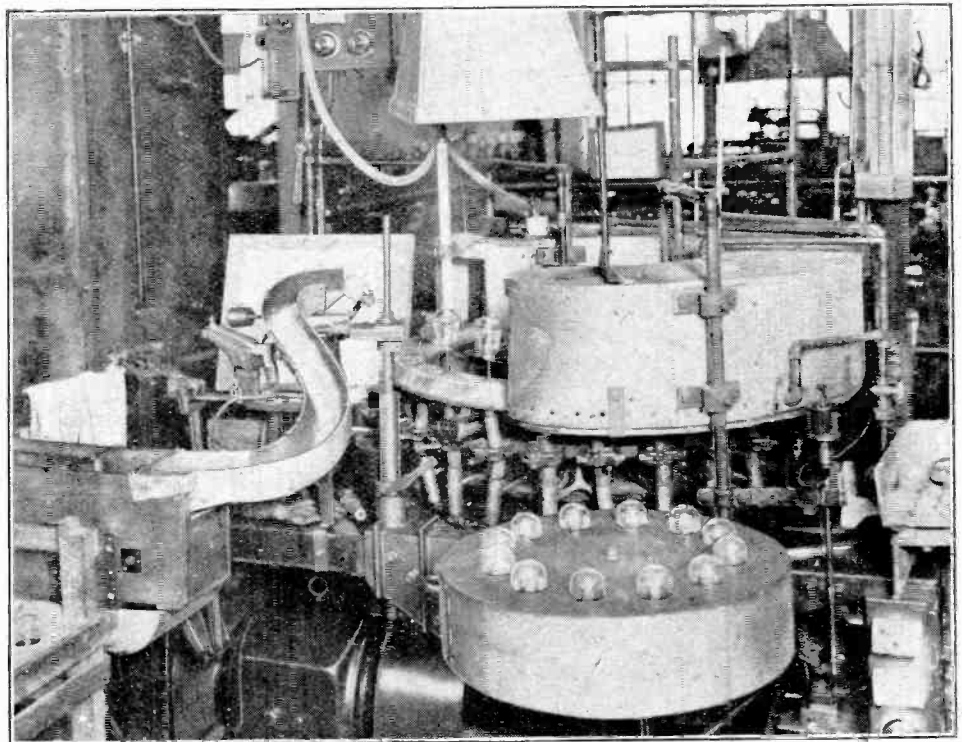

Fig. 12.—Another machine, used at the Osram Works, for pumping valves. The valves are heated in the large chamber.

Valves in the Making.—

in such a manner that there is no need for the small support wires just referred to, a projection of circular cross-section being provided on each side as sketched. Anodes of circular cross-section usually have a flat projecting surface where the two edges meet. These edges are securely fastened by welding, and provide a suitable surface for attaching the anode to the supporting wire fastened to the glass foot.

Anodes for valves characterised by a coating of silvery appearance on the glass bulb have a small piece of magnesium welded to them.

Assembly of the Wires and Supports.

A rather intricate piece of machinery is used in connection with the sealing of the wires in the foot of the valve. The wires necessary for supporting the electrodes are placed in a machine, such as illustrated in Fig. 7 and Fig. 8, and a piece of glass tube of the correct length is put over them. In the case of the pipless type of valve a tube of small diameter (used for exhausting) is also put in position. The circular table then turns and gas flames of a certain intensity play on the glass tube. The table moves again and puts the jig carrying the wires and tube in another position, where it receives further heating. Then the lower portion of the tube is spread out, and finally the top of the glass tube is pressed round the wires forming the pinch.

In the case of certain power valves, the foot of the tube is shaped before being put on this machine.

When the element is for use in a "pipless" valve a glass tube of small diameter for connecting to the pumps is automatically secured in position during the above operation.

Finally, the completed unit, comprising the glass foot and wires and the exhaust tube, when one is used, is removed from the machine and placed on a table. There the glasswork is annealed.

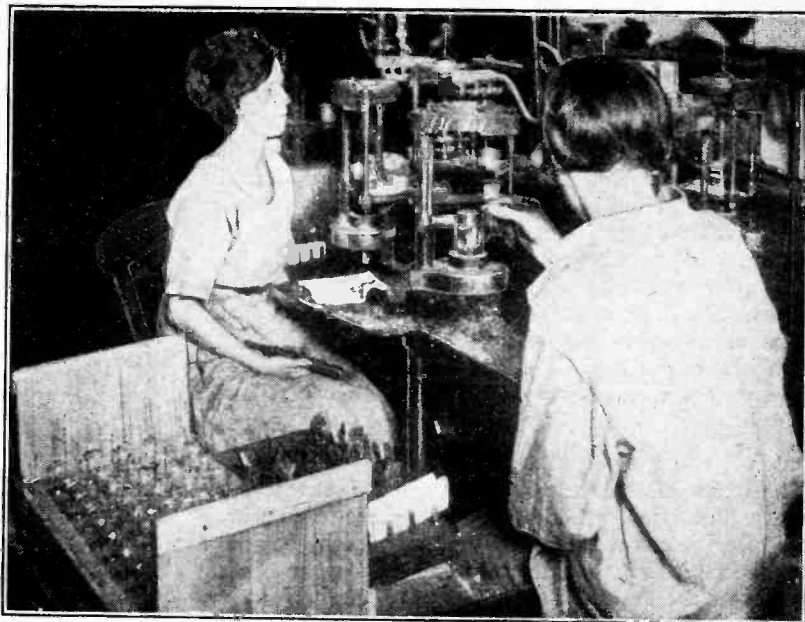

Fig. 13.—A machine at the Mullard Works for sealing the bulb to the foot of the valve.

A view of the complete machine involved is given in Fig. 8. A close-up view showing the glass tubes and the jigs for holding the parts appears as Fig. 7. It is very interesting to watch this machine working. The operations are timed exactly, and the glasswork is heated to just the right degree at each stage of the operation.

Assembly of Electrodes.

The first step in the work of mounting the electrodes is to put the foot in a jig and to cut and bend the supports to the right length and shape. Then the filament is usually fitted, but first the wire for the filament is treated to cleanse it, and then the filament is put in and the ends welded to the supports. The grid and anode are then assembled, being fixed to the supports provided by welding.

The various manufacturers have machines of different design for assembling the elements, but they all endeavour so to arrange the construction that the elements are auto-

matically located and fixed in position. At the works where the Burndept valves are made, the writer saw a particularly interesting method of dealing with the filaments of power valves. The foot was put in a jig, and the filament wire (previously cleansed) was put on and the ends welded. When removed from the jig the filament curled up. It was straightened, and stretched by exactly the right amount, by another ingenious piece of apparatus in which the filament was heated in the presence of nitrogen and

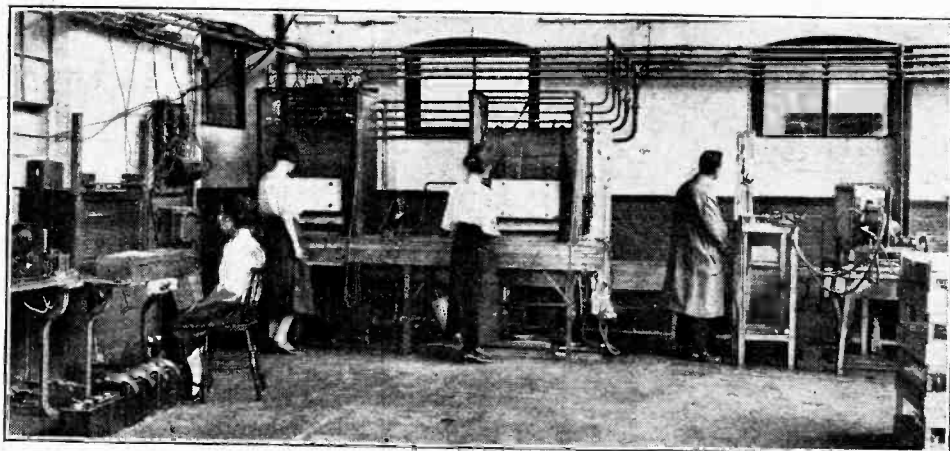

Fig. 14.—A corner of the laboratory at the Burndept valve factory. Several pumps can be seen.

Valves in the Making.—

hydrogen to prevent spoiling the surface of the filament.

As would be expected, filaments for valves of the 60 milliamper class require special methods, as the wire is so fine. In the Mullard valve the fine filament wire has fastened to it at suitable points small clips of nickel as shown in the sketch of Fig. 5, the clips being spaced to give filaments of the right length. This wire is laid in position, and the clips are welded to the filament supports, after which the ends are cut off. At the Osram valve works a different method is used. The filament wire is first welded to a bow of thicker nickel wire (Fig. 5), which is then put in position and welded to the supports. The ends are then cut off and the portion not required removed.

Fitting the Bulb.

The bulbs for the valves are obtained from the glass manufacturer already shaped, and they are fitted with a glass tube for attachment to the exhaust pipe by operators who take short lengths of the tube and fix them by heating the tops of the bulbs. Then the foot of the valve carrying the electrodes is mounted in a machine and the bulb placed over it in such a manner that the lower part of the bulb rests on the belled-out portion of the glass foot. A machine for this work is illustrated in Fig. 13. The machine now moves, and the part of the valve which rests against the foot is heated by gas jets. After a few seconds the table moves again, and the glasswork is again heated while the unit rotates. Gradually the glass on the bottom part of the bulb is softened, until, finally, the bulb and foot unite, making an air-tight joint. The bulb then cools, and the operator removes the waste portion of the glass and places the unit on another table provided with means for annealing the glasswork.

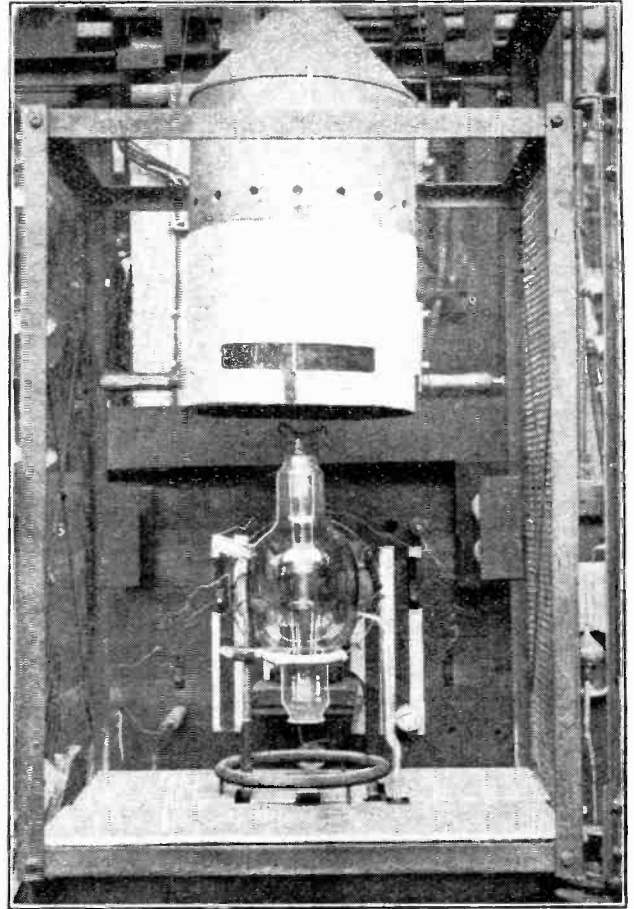

Fig. 15.—A transmitting valve on the pump at the Osram Works. During pumping the elements are heated by electron bombardment while the bulb is heated by gas flames.

Pumping and Sealing.

The valve is now ready for the pumps, and it should be noted that during evacuation the valve is heated to drive off gases from the metal supports and elements and from the walls of the bulb.

There are two methods of heating the elements. One method consists in connecting to the grid and plate a high voltage and burning the filament at a high temperature. The electron current then heats the grid and plate to a bright red colour. In the second method a coil carrying high-frequency current is placed over the valve, and the elements are heated by induction.

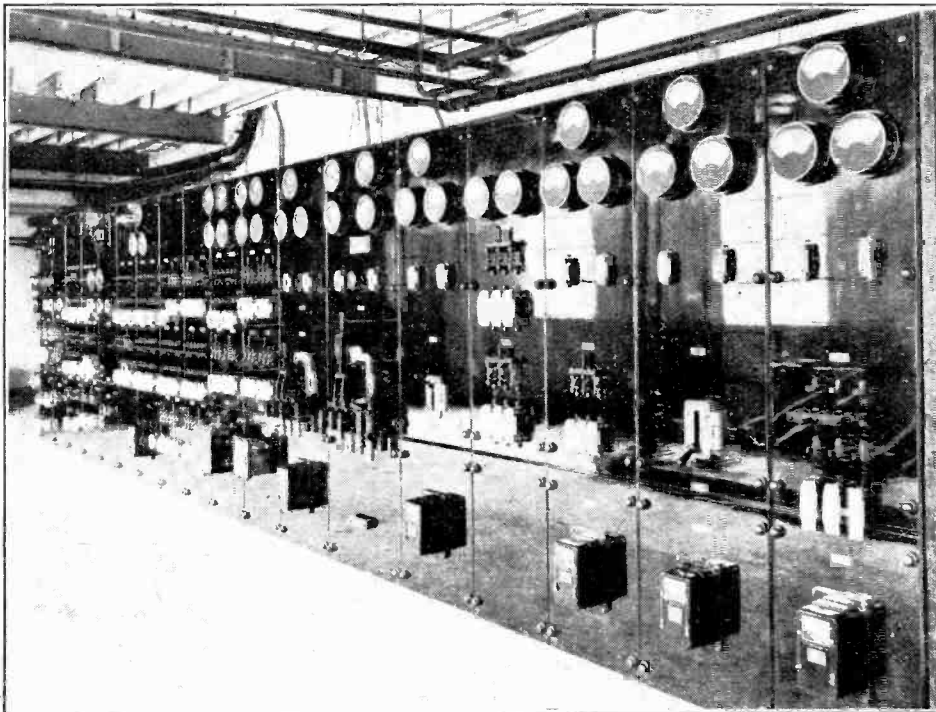

Fig. 16.—The switchboard at the Burndept valve factory.

Valves in the Making.—

With the former method a certain amount of filament wastage occurs. This is of no account in the case of power and other valves having relatively robust filaments, but the method would not be satisfactory for valves of the 60 milliamper class. These valves have filaments of such fine wire that every care has to be taken of them, and it is usual to heat the anode and grid of the valves by the second method. The high-frequency current passed through the coil of the *eddy current heater* (as the coil carrying the current is called) may be as much as twenty amperes.

In one form the operator has a rod of insulating material, to the end of which is fixed the coil which carries the H.F. current, and holds the coil over the valves during the pumping process. Another method, illustrated in Fig. 10, consists in placing over the valves on the pump coils carrying the high-frequency current.

There are a number of methods of exhausting the valve. In one method the valves are placed on the pump by sealing the tube left on the bulb to the main exhaust tube as illustrated in Figs. 9 and 10. The cover of the pump is then pulled down and the bulb heated while the pump is exhausting the valves. Finally the valves are sealed off and removed from the pump.

In another method the valves are put on a pumping machine, illustrated in Fig. 12. The valves are of the pipless type, that is, the pip is in the glass foot instead of at the top of the bulb as is usually the case. As the valves move round they are heated by gas flames while they are being evacuated, and the speed at which the part of the machine carrying the valves rotates is so adjusted that by the time a valve has returned practically to the point where it was connected, the exhaust tube is sealed. The valve is then picked up by the fork, which can be seen in the illustration (Fig. 12), and slides down the chute to a table where the valve is tested.

The Getter Process.

In order to reduce the total time taken to remove the last traces of gas and also to improve the vacuum during the life of the valve, what has come to be known as the "Getter" process is used. The getter usually employed is metallic magnesium, and as mentioned above, a piece of this metal is fixed to the anode during the construction of the anode. If valves of the dull emitter type, which are being described, are to give satisfactory service, it is absolutely essential to provide an extremely good vacuum, as the presence of minute traces of gas will impair the dull emitting properties of the filament. If the valve is heated by electron bombardment or by the eddy current method, the magnesium volatilises, and combines with the last traces of gas in the valve.

The particular method of volatilising the magnesium and the stage in the production depends on the type of valve. Power valves such as the 5 volt 0.25 ampere type are usually exhausted by the pump in the usual way, and then heated by burning the filament and applying a high voltage to the anode and grid. Valves with thin filaments, on the other hand, are usually heated by the eddy current method; the inducing coil which carries the high-frequency currents being held over the valve until the magnesium flashes.

One particularly neat and efficient way of "gettering" valves can be understood by the illustration of Fig. 11. If this picture is examined, it will be seen that the valves at the back are clear. These are valves which have been pumped and received a preliminary testing, but they have not been "gettered." The table turns, and while the valves are passing through the tunnel of metal gauze, the filaments are heated and a voltage is applied to the anodes and grids. The electron current heats the elements, the magnesium volatilises, and cleans up the valve and is de-

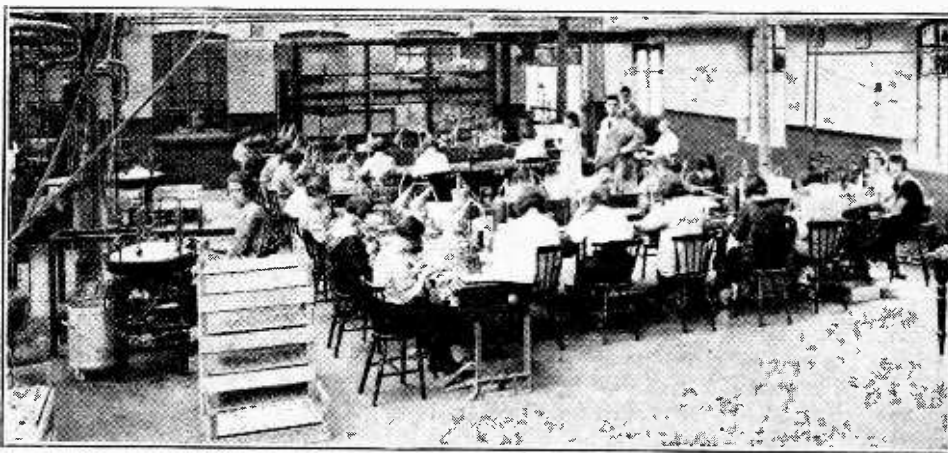

Fig. 17.—A corner of the Assembly Room at Burndep's valve factory

posited on the bulb, giving it the well-known silvery appearance. The table turns in a clockwise direction, and valves which have been "gettered" can be seen leaving the tunnel.

Heat Treatment.

As mentioned above, it is necessary to treat the filament of dull emitter valves before they will emit electrons at the usual working temperature. The heat treatment consists in burning the filaments at a high temperature (about 2,900° K.) for about a minute, then heating the filament at a temperature of about 2,250° K. for three or four minutes, and finally reducing the temperature to about 1,700° K, which is the normal working value.

In the flashing process the filament is heated to a high temperature for a minute by applying to the filament a voltage between three to three and a half times normal. Thus for a 5.5 volt valve a voltage of about 19 would be applied. The exact voltage to be used depends on the particular composition of the wire used as the filament, and is experimentally determined for each reel of wire.

It should be noticed that during this process a voltage



Fig. 18.—Testing valves at the Mullard Factory.

is applied to the filament only; the anode and grid are left free. The treatment has the effect of causing thorium to diffuse to the surface of the filament, forming a very thin layer of thorium.

Ageing and Testing.

After the valves have had their filaments treated, the bases may be fitted and the connecting wires soldered up, or the valves may be put on the "ageing" rack without bases. The ageing process consists merely in running the valve under normal conditions for a time in order that it shall settle down, as it were. Sometimes the bases are put on before the ageing process, and sometimes the reverse is the case, but in nearly all instances that have received the attention of the writer, testing is carried out after the ageing process, it being understood that the valves have all undergone a preliminary test to eliminate those of faulty construction. The advantage of testing the valves after they have settled down is apparent.



Fig. 19.—A proportion of the valves at the Burndept valve factory are taken each day and carefully checked on this testing outfit.

Testing is quickly, though carefully, done by operators who place the valve to be tested in the socket provided on the test panel, and note the filament current, filament voltage, grid current, and plate current. Valves which do not give the emission required, or whose amplification factor or impedance are outside certain limits which are fixed for the different types of valves, are rejected. A microammeter is employed to measure the grid current, and when used with a reversed grid voltage indicates the "back lash" current, which is a rough measure of the degree of vacuum in the valve.

Marking and Packing.

All valves are, of course, marked in a certain manner to distinguish the type. It is unfortunate, however, that all manufacturers do not give valves of similar rating a similar type letter and number. For instance, power valves of the 5 volt 0.25 ampere class are called B.4 by the B.T.H. Co., D.E.5 by the Marconi and Osram Cos., and D.F.A.1 by the Mullard Co. It would be much more

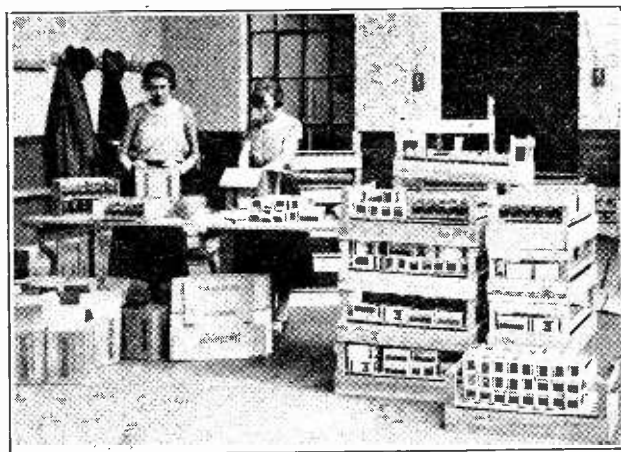
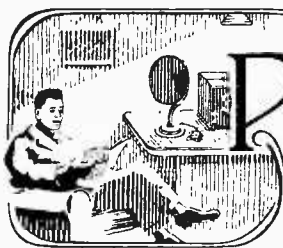

Fig. 20.—A corner of the Packing Room at the Burndept valve factory

convenient if these valves, which after all have very similar characteristics, and are designed for use in L.F. amplifiers, were all marked in the same manner. A convenient marking would be L.525, meaning a L.F. valve requiring a filament voltage of 5 and taking a current of 0.25 amperes, a method which has been described on several occasions in these pages. It is interesting to note that the manufacturers of the new Burndept valves (Radio Accessories, Ltd.) have adopted this method of marking valves.

The various manufacturers usually include a slip indicating suitable operating voltages. The importance of giving full information as to the correct grid and anode voltages cannot too strongly be emphasised, while users should always work their valves within the limits of filament and anode voltage recommended. The effect of overrunning the filament in reducing the life of a valve is very well known, but it does not appear to be known that it is equally important not to exceed the anode voltage stated by the makers. The maximum anode voltage which can be safely used, consistent with long life, depends on the type of filament and on the size of the bulb. With dull emitters it is found that the life is reduced when high anode voltages are used.



PRACTICAL HINTS AND TIPS

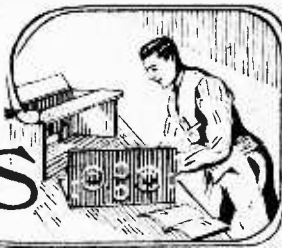

A Section Mainly for the New Reader.

GRID CONTROL OF DETECTOR VALVES.

FOR reception of the shortest wavelengths, where high-frequency amplification is impracticable, every effort should be used to get maximum efficiency in the detector valve. While the introduction of a variable grid leak will sometimes improve matters, these components are often rather uncertain in operation, and it is generally impossible to calibrate the settings. The use of a potentiometer to control the steady voltage of the grid is to be recommended. This should be connected as shown in Fig. 1, the positive voltages being applied through the leak, which is connected to the slider. This arrangement has an additional advantage over the vari-

ample. The arrangement is equally to be recommended on the longer wavelengths.

REACTION ADJUSTMENTS.

The sensitiveness of most valve receivers is largely due to the building-up of an initially weak signal by the use of reaction for regeneration. The inexperienced operator is often misled by the fact that a certain slight adjustment gives louder signals, and thinks, perhaps, that his detector valve is functioning better when the filament is actually being over-run, or when the H.T. voltage is increased. In this case, what is probably happening is that the valve is operating less efficiently as a detector, but is much closer to oscillation point, the gain in regeneration more than balancing the loss in detection.

Similarly, when using grid control of a detector, as the grid is made less positive the valve tends to oscillate more freely, and the same conditions obtain. The obvious method of ascertaining the best working conditions is, in the case of a detector without high-frequency amplification, to use temporarily no reaction whatever, and to make the various alterations necessary. The matter is more complicated where high-frequency amplification is used, and whether merely tuning the set or making experimental alterations, one should always be sure that an apparently improved result is not merely due to having increased incidental reaction.

USING A SUPERHETERODYNE ON THE LOCAL STATION.

Users of superheterodyne and, to a lesser degree, of other multi-valve sets not fitted with switching, will find that such receivers are extremely extravagant for use in reception of a near-by station. Often, indeed, a certain amount of "mush" and other interference is brought in, and the

receiver may then be said to be definitely unsuitable for the purpose. While a set with one or two H.F. stages will generally function well on a really strong signal if the filaments of the valves preceding the detector

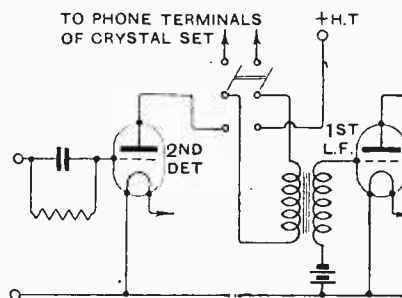

Fig. 2.—Superheterodyne modification.

are merely extinguished, this is not the case with the supersonic receiver. The arrangement shown in Fig. 2 will be found very practical and convenient for those situated at a few miles' distance from a broadcasting station, and whose receivers are fitted with two stages of L.F. amplification. No extensive alterations are involved.

A double-pole change-over switch is arranged to connect the primary of the first L.F. transformer either in the anode circuit of the detector valve for normal operation, or to the output terminals of an ordinary crystal set for local reception.

Both sets may be kept permanently connected together, and if the L.T. battery of the multivalve set is not normally earthed, it may be necessary to do this to prevent low-frequency howling. The aerial lead-in wire may be fitted with a plug, sockets for which should be provided on each set. The change-over thus only takes a few seconds.

It may well be that the first L.F. transformer is of low ratio, suitable for following the usual type of detector valve, in which case a perikon or other high resistance detector will give better results than galena.

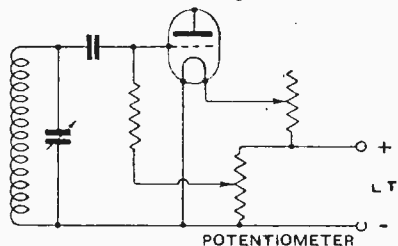

Fig. 1.—Control of grid potential in a detector valve.

able leak, in that the control knob of the potentiometer is at earth potential, minimising hand capacity effects.

It will often be found that the best adjustment for detection is not the best for the smooth reaction control so essential for long range work. It is generally possible to strike a good balance between the two.

To obviate the necessity for switching off or disconnecting the L.T. battery, which would otherwise slowly discharge itself through the potentiometer, this latter may be connected between negative L.T. and positive filament, thus being automatically cut out as the valve is switched off. The maximum positive bias thus obtainable will generally be

CARE OF LOW-CONSUMPTION DULL EMITTERS.

It is safe to say that over 50 per cent. of the dull-emitter valves of the type consuming 0.06 ampere at about 3 volts come to an untimely end through overrunning of the filament. Even an expert finds it almost impossible to decide by visual indications if the filament is at correct brilliancy, and it is a regrettable fact that, as often as not, results are better when an excessive current is passing. These remarks apply to many other types of dull emitter, and a reliable voltmeter, by which the actual voltage applied across the filament may be measured, is certainly one of the most useful possessions of any wireless amateur.

A certain amount of care is necessary in the choice of an instrument, as many of the cheaper patterns have a fairly low resistance; often, in fact, comparable with that of the valve filament. Such a meter would give quite misleading results, as, when it is removed, the voltage across the valve would increase considerably. At the same time one should consider the advisability of obtaining a meter with a double scale, reading up to some 120 volts, as it is difficult to operate correctly a low-frequency amplifier when the actual voltage of the high-tension battery must be taken on trust. High resistance in the meter windings is of even greater importance here.

A simple method of switching may be devised, whereby the meter may be connected across any valve in the set at will, or more simply, sockets may be provided on the face of the panel, the meter leads being fitted with plugs.

○○○○

COUPLING L.F. VALVES TO A DETECTOR OF HIGH IMPEDANCE.

It has frequently been pointed out in this journal that the use of anode or "bottom bend" rectification will give better quality reproduction than if the more conventional leaky grid condenser method is used. It is an unfortunate fact, however, that valves suitable for the former method, particularly the D.E.Q., which is specially designed for the purpose, are of extremely high impedance, and probably no transformer is available which is suitable for following such a valve.

One of the best methods of coupling a high impedance detector valve to the succeeding L.F. amplifier is to use a choke of considerably higher inductance than usual, and it will be found that two good ordinary chokes connected in series provide a very effective and distortionless coupling.

○○○○

VALVE FILAMENTS IN SERIES.

With the multiplicity of valves now available, it is often desired to combine in one receiver valves taking

with a careful study of the skeleton diagram, in which the positive and negative sides of each filament are marked, will make the matter clear. In the case of valves performing every function except that of detector, it is usual to make the return connection to the negative end, often through a bias battery.

Sometimes, when using the series connection, a certain amount of instability will be noticed, particularly in H.F. amplifiers, due probably to the fact that some of the filaments are more or less "in the air."

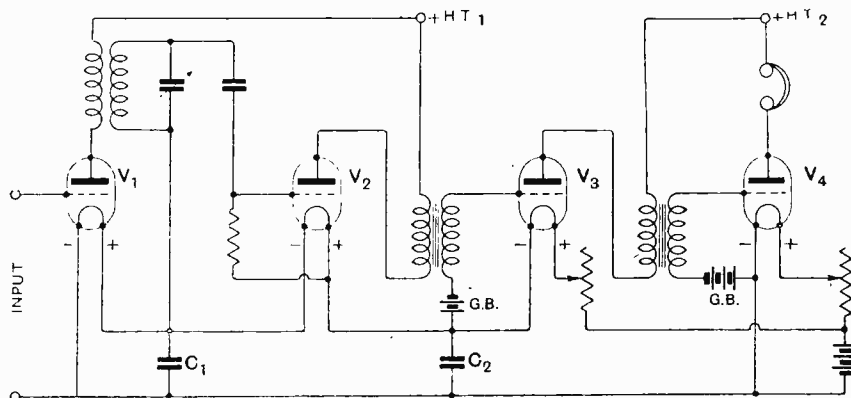

Fig. 3.—Valve filaments in series.

widely different L.T. voltages. As an economy measure, the possibilities of connecting the filaments of low voltage valves in series with each other should not be neglected. If low and high voltage valves are used together in parallel with the L.T. battery, a considerable amount of energy will be wasted in heating the filament rheostats. At the present time it is often necessary to use a six-volt valve in the last stage, as no other can really adequately handle the power necessary for powerful loud-speaker reproduction. In the circuit given herewith (Fig. 3) it is assumed that three of the deservedly popular 1.8—2 volt general-purpose dull emitters in series are used in conjunction with a six-volt power valve. The total consumption will be in the neighbourhood of 0.6 ampere (0.35 for the three first valves together and 0.25 for the last), whereas if all the valves were in parallel it would be 1.3 amp.

There seems to be a good deal of uncertainty as to where the grid return leads should be connected, and it is hoped that these hints, together

Luckily, this trouble may be obviated by "tying down" these filaments to earth potential, as far as H.F. and pulsating currents are concerned, by the insertion of large fixed condensers (C_1 , C_2 in the diagram). For H.F. work capacities of about 0.01 are ample, while for L.F. 1 mfd. is not too much.

○○○○

THE CHOICE OF A DETECTOR.

Now that loud-speakers capable of giving extraordinarily faithful reproduction are available, and that there is a growing appreciation of the fact that precautions must be taken at every stage to avoid distortion, the designer is often at a loss to know what type of detector to use. It may be said, in a few words, that the leaky grid method is the most economical and sensitive from the point of view of range, while the "bottom bend" rectifying valve or crystal may be recommended for quality. There would seem to be no real foundation for the belief that the use of a crystal following H.F. valves reduces the range obtainable.

THE SELECTION OF A VALVE.

Characteristic Curves and their Significance.

By N. V. KIPPING and A. D. BLUMLEIN.

THE constants which a manufacturer usually advertises for his valves are the following:—

- (a) Filament consumption.
- (b) Grid voltage—anode current characteristics for one or two plate voltages, and sometimes one or two grid current-grid voltage characteristics.
- (c) The characteristic impedance R_0 .
- (d) The amplification factor m .

Manufacturers also frequently give the best plate and grid biasing voltages for a particular use of the valve. These could, however, be separately determined from the curves.

In discussing the reasons why this information is necessary, the opportunity will be taken of mentioning important or interesting points which fall under each heading.

Filaments and Filament Consumption.

As is well known, the object of a valve filament is to provide a convenient source of electrons, which, when attracted to the plate or anode, constitute a conducting path between the filament and the anode. The anode current is actually the rate of flow of these electrons, and is controlled by the combination of (a) the anode and grid voltages, and (b) the number of electrons emitted by the filament in a given time. Actually, the filament is constantly emitting electrons—though comparatively few when it is cold—but unless specially attracted away by some external means, these are drawn back to the filament; the phenomenon is similar to the cloud of spray over a glass of sparkling muscatel. In a valve, the positive potential of the anode is the means of attracting some of the electrons to the anode. The grid is a control, as its potential acts similarly to that of the plate, only is more effective, being nearer to the cloud of electrons. By making more positive the plate (or grid), more and more electrons are attracted away from the cloud, until ultimately all the electrons emitted by the filament are attracted to the plate (or grid). When this happens, the plate current is said to have reached its saturation value, or to be the saturation current.

It is then clear that the filament must be composed of a substance which will easily emit electrons. The early valves contained a filament of tungsten which emitted electrons freely when heated to white heat. This type of valve is known as a bright emitter. A more recent development is the dull emitter, whose filament consists of a metallic core (which acts as a heater) coated with an emissive compound. This type of filament does not need to be heated beyond dull red heat to obtain a satisfactory emission.

Increasing the filament current of a valve (that is

increasing the temperature of the filament) increases the emission obtained from it. This is only limited in the bright emitter by the sudden melting of the filament at a certain temperature. In the dull emitter the temperature is first reached at which the emission ceases to rise rapidly and nothing is to be gained by heating the filament above this temperature, which is known as the temperature saturation point.

In practice, sufficient emission can be obtained from a valve filament for the purpose for which it is made by heating the filament to a temperature well below the above limitations, and it is not economical to use higher temperatures. The life of the filament depends to a great extent on the temperature at which it is run, and the voltage and current which a manufacturer advises for a particular filament are settled by a compromise between big emissions for a short life, and small emission for a long life. In general, the lower temperature of dull emitters results in their having longer lives than bright emitters, though more harm is done to the former by "overrunning" (overheating) the filament to obtain increased emission.

Manufacturers' figures for filament voltage and current should therefore be taken as the maximum values permissible.

The information given by manufacturers is usually in terms of filament current and filament voltage, the product of which represents the power which is absorbed when the valve is working. This filament power may be regarded as wasted as regards what is often called the output power of the valve, but is of interest to us as determining whether the filament of the valve may be heated by dry cells or whether accumulators are necessary. As we can only obtain multiples of two volts from accumulators, and multiples of 1.3 volts from dry cells (which it is safe to take as 1.9 volts and 1.2 volts respectively), no valve should be selected of which the filament voltage is not a multiple of one of these two voltages (depending upon whether accumulators or dry cells are to be used), unless it is intended to operate the filaments of the valves in series, in which case all the filaments must take the same filament current. A small voltage drop in a filament rheostat should be allowed for, however, so that a control of the emission may be obtained. Bright emitters always need accumulators as filament battery, but many dull emitters may be run conveniently from dry cells. Certain dull emitters are made having very low filament consumption (less than one-fifth amp.) and are very useful when the use of small dry cells is desired. These, however, have other disadvantages which will appear later.

There are now on the British market something like 90 different types of valve suitable for reception purposes, and the selection of the best for any particular purpose from amongst this assortment is a matter of some importance and presents no little difficulty. Without any reference to individual makes, it is hoped that what follows will make the task less formidable and more likely to lead to successful results.

The Selection of a Valve.—

Characteristic Curves.

We have already stated the two factors which control the plate current of a valve. They were (a) the plate and grid voltages, and (b) the filament emission. Factor (b) is for a given valve more or less constant, as the filament is, or should as a rule be, run at its rated temperature. The fact that the plate current is increased by an increase of plate or grid voltage is due to the attraction of the electrons by the electrostatic field induced by the grid and plate potentials. The grid being nearer to the

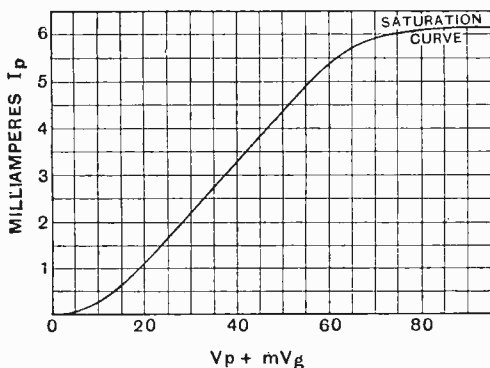

Fig. 1.—Typical "lumped" valve characteristic.

filament than the plate the field due to the grid potential is greater per volt than that due to the plate potential. The number of times that the grid is more effective than the plate in controlling the plate current is called m —the amplification factor of the valve. That is to say, if a voltage V_g on the grid and a voltage V_p on the plate caused a plate current I_p , then a plate current I_p would also be caused by a voltage $V_p + mV_g$ on the plate, when the grid had the same potential as the filament.

Above V_g is taken as positive. If it is negative, then clearly it will repel electrons and so reduce the attractive effect of the plate voltage. This is, however, taken account of in the above expression if V_g is given its proper sign. The expression is applicable, in fact accurate, whenever V_g is negative, but when V_g is positive, all the electrons attracted from the filament do not reach the plate, and I_p falls slightly; the expression may, however, be considered accurate for practical purposes.

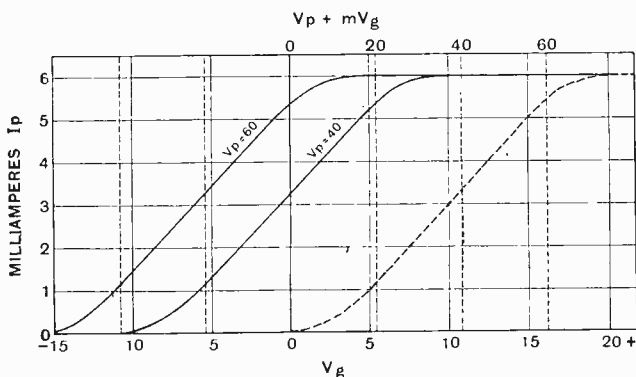

Fig. 2.—Diagram showing the development of ordinary characteristic curves from the "lumped" characteristic. The "lumped" curve, together with the horizontal scale divisions representing $V_p + mV_g$, are indicated by the dotted lines.

Fig. 1 shows a curve relating I_p with this expression $V_p + mV_g$.

Curves of this type are known as lumped characteristics, because the effects of the plate and grid voltages are lumped together. The more usual form of characteristic curve published by manufacturers shows the relationship between grid voltage and plate current, for a certain definite plate voltage. This may be developed from the lumped characteristic by shifting the curve to the left by a voltage equal to V_p , and making the horizontal scale so that the distance representing 1 volt is increased m times. This is done in Fig. 2, in which the dotted lines are the scales for the lumped characteristic (which is also dotted) and the full lines are correct for the plate current-grid voltage characteristics. In Fig. 2 m has been taken as 3.7. The curves shown in Fig. 2 do not exactly represent a practical case, as they, as well as Fig. 1, do not take into account the reduction of plate current which occurs when the grid becomes positive and attracts some of the electrons to itself. When this happens a current flows from filament to grid. This current, known as the grid current, is often plotted by manufacturers against grid voltage on the same curve as the other characteristics as in Fig. 3, where curves are shown for several different plate voltages. By stepping off directly propor-

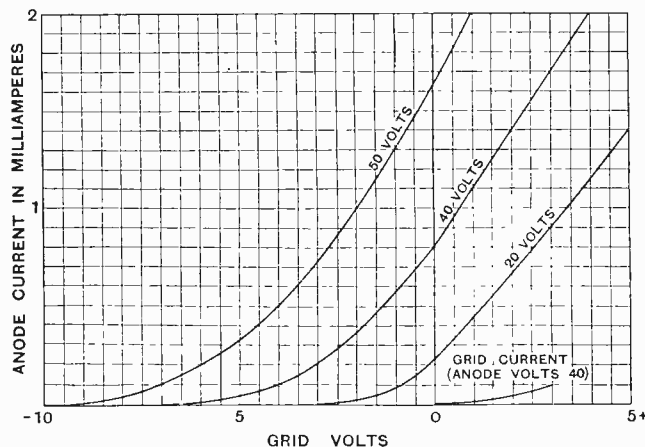

Fig. 3.—Relative magnitudes of the anode current and grid current characteristics of a typical receiving valve.

tional distances to the left or to the right, the straight line portion of the plate current characteristics for other plate voltages may be obtained with a reasonable degree of precision.

In using a valve a steady potential is applied to the plate (H.T. battery), and another, which may be negative or positive with respect to the filament, is applied to the grid (grid bias battery). These potentials are always reckoned with respect to the negative end of the filament.

When an alternating potential is applied to the grid, it becomes added to the grid bias potential, and causes corresponding fluctuations in plate current, and in plate voltage if a load is connected in the plate circuit of the valve. For amplification purposes, it is desirable, to avoid distortion, that alterations in plate current be exactly proportional to the alterations in grid voltage which cause them, or that the shape of the input and output waves should be the same. This clearly will not

The Selection of a Valve.—

be the case if the steady plate current (due to the D.C. plate and grid voltages) is of such a value that it falls upon one of the curved extremities of the grid voltage-plate current characteristics of the valve, and to avoid this

allows the maximum variations either way in A.C. grid voltage, without distortion.

We see, then, that characteristic curves are the only means of determining (without taking the manufacturers' word for it) the grid and plate potentials to be used in order to avoid distortion. It is not always safe to take the manufacturers' views on the best operating voltages, as these necessarily depend to some extent on the particular use to which the valve is to be put. This, however, is not the only purpose for which the curves may be used, as from them we may calculate the amplification factor m (already mentioned), and the plate impedance R_o .

Characteristic Impedance, R_o .

This quantity, often called the characteristic impedance, is not the D.C. resistance between filament and plate which one might calculate by dividing the normal plate voltage by the normal plate current, because such a calculation does not take into account the effect of the grid voltage on the plate current; actually R_o is obtained

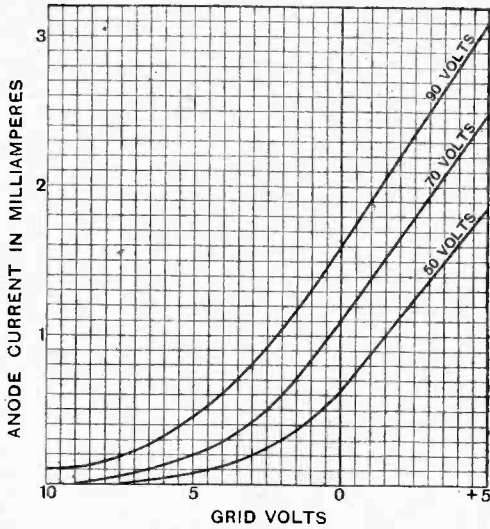

Fig. 4a.—Characteristic curves of a general purpose triode emitter valve.

it is desirable so to choose the grid bias voltage that the nett grid potential at any moment never causes this to happen. Clearly, therefore, this grid bias voltage is best chosen so that it lies in the middle of the straight part on the negative side of the characteristic used; according to the plate voltage one wishes to use; this

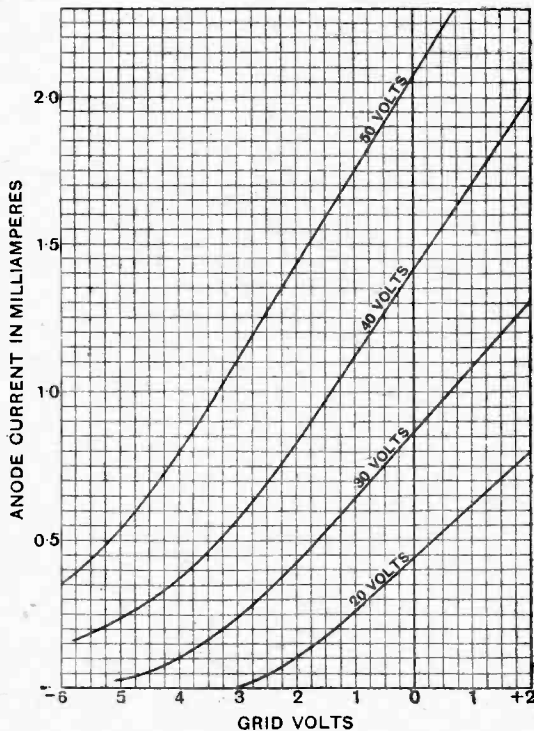

Fig. 4b.—Characteristics of a general purpose diode emitter valve.

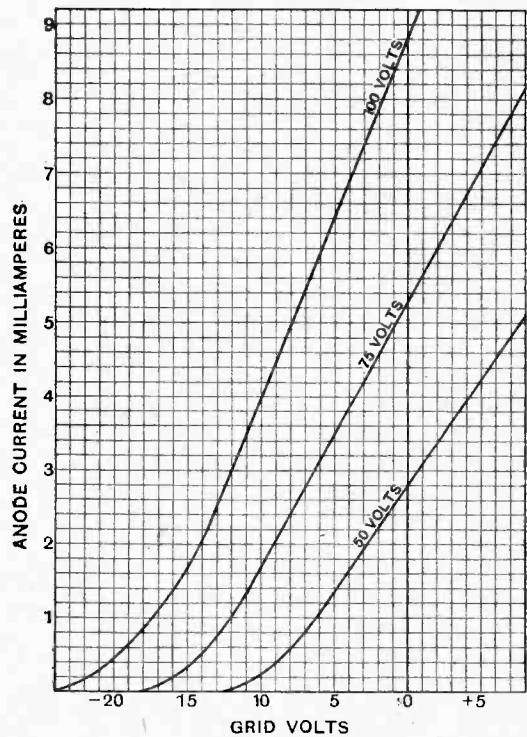

Fig. 4c.—Characteristics of a dull emitter power amplifying valve.

by dividing a change in plate volts which corresponds to a change in plate current over the straight part of the characteristic. One might, for example, find the following figures from a set of curves:—

At a plate voltage E_{p1} and at a given grid voltage, plate current equals A_{p1} ampere.

At a plate voltage E_{p2} and at the same grid voltage, plate current equals A_{p2} ampere.

The R_o is given by $\frac{E_{p1} - E_{p2}}{A_{p1} - A_{p2}}$ ohms.

This is perhaps a convenient moment to put a word of warning about the curves published by manufacturers. It must be remembered that the curves for valves of all

The Selection of a Valve.—

types having very different characteristics are drawn for simplicity on curve sheets of similar size. This necessitates a widely different selection of scales, and it often happens as a result that two valves suitable for widely different purposes appear at a glance to have similar characteristics. Care must, therefore, be taken that the scale used is noted.

Having said this, let us refer to Fig. 4, for which three sets of curves have been chosen at random from manufacturers' catalogues. From these we may conveniently select a practical example for the calculation of R_0 and m .

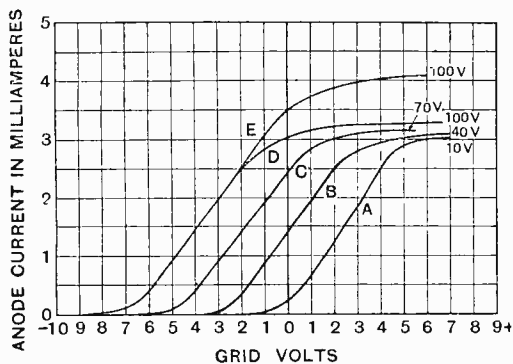

Fig. 5.—Diagram illustrating the effect of curvature of the valve characteristic in producing distortion.

From the curves in Fig. 4(B) we find that -1 volt is an average grid potential. At this value, when the plate voltage is 30, the plate current is 0.64 milliamperere. When the plate voltage is 40, the plate current is 1.22 milliamperere. The increase in plate voltage is 10, the corresponding increase in plate current is 0.58 milliamperere = 0.00058 ampere.

By Ohm's law, $E = RI$

$$R = \frac{E}{I} = \frac{10}{0.00058} = 17,300 \text{ ohms (approx.)}$$

Thus the characteristic impedance R_0 of the valve considered is found to be 17,300 ohms. Let us also calculate m from Fig. 4(B).

Take the curves for which the plate voltage is 30 and 40. A convenient method will be to find the decrease in grid voltage necessary to maintain the plate current at 1 milliamperere when the plate voltage is changed from 30 to 40. From the curves we see that for a plate voltage of 30, and a plate current of 1 milliamperere, the grid voltage is $+0.65$. For a plate voltage of 40 and a plate current of 1 milliamperere, the grid voltage is -1.5 . The change in grid voltage is, therefore, 2.05 for a change in plate voltage of 10. The amplification factor m , therefore, equals $\frac{10}{2.05}$, which is about 5.

Distortion and Grid Current.

Apart from detectors, distortion in valves is usually due to working over a curved part of the grid voltage-plate current characteristic of the valve as already mentioned. It may also be caused by grid current flowing during part of the cycle as a result of too high an input voltage.

Take the imaginary case of a valve having characteristics as in Fig. 2. It will be clear that, so long as the

variations in input grid voltage always insure that the straight part of the curve is not overlapped, the plate current will always be directly proportional to the input voltage, and distortion will not occur. Consequently, it is of prime importance so to adjust the grid bias for low-frequency amplifiers, where distortion is of great importance, that this requirement is met. This consideration, however, is not the only one, as combined with it is the necessity of insuring that grid current will not flow during any part of the cycle. The reason why grid current causes distortion unless specially counteracted is because wherever the grid bias is made to operate through a grid leak or a high impedance secondary of a transformer, grid current will develop an appreciable voltage across this resistance or secondary. This will become added to the grid bias, making the grid more negative or less positive and thus have the two effects of reducing the output of the valve and causing distortion. This grid current causes distortion both by opposing the grid voltage which causes it, thus cutting off the peak of the input wave, and so the output wave, and also very likely by altering the mean grid bias, and thus overlapping the straight part of the curve.

To avoid these two causes of distortion, the plate voltage and grid voltage must be chosen with reference to the characteristic curve. Take the curves of Fig. 5, and suppose that we wish to use a plate voltage of 10. We see from curve A that it would be impossible to choose a satisfactory grid bias, because, no matter what its value, we should either be working on the curved part of the characteristic, *i.e.*, we should have grid current flowing. With a plate voltage of 40, however (Curve B) we find that a grid bias of -1 volt would enable us to work satisfactorily for small input voltages, because we can go 1 volt either side of the bias without overlapping the straight part of the characteristic, and without causing grid currents due to a positive grid. Even more output could, however, be obtained from the valve without distortion by using a plate voltage of 70 (Curve C). This would enable us, using a grid bias of -2 volts, to move two volts either side of this without causing distortion. If we were to use a plate voltage of 100 (Curve D), no increase of distortionless output could be obtained over the 70-volt condition, since we are still limited to a variation of 2 volts either side of the grid bias voltage of -4 . This limitation is now imposed by the curve at the top of the characteristic instead of by a positive grid.

A slightly greater output of 100 volts over that at 70 volts could be obtained by increasing the filament current (resulting in Curve E), but this would be at the expense of the life of the valve. The best curve to use then would depend first upon the input voltage, and second upon the convenience which might attach to using a higher plate voltage than was essential.

Effect of Load on Characteristic Curves.

So far, all that has been said has been referred to the output of the valve in terms of plate current, when the plate is connected directly through the H.T. battery to the filament. If the valve is to produce any useful A.C. output, however, it must have a load connected in its plate circuit. This load may consist of a trans-

The Selection of a Valve.—

former primary, an anode resistance or choke, coupling, etc.

In general, only an anode resistance will materially affect the D.C. plate potential, as the steady plate current flowing through the smaller resistance of other types of load will produce only a small IR drop between the H.T. battery and the anode.

All types of load, however, have an opposing effect on the alternating plate current, and the result of this is that the actual plate current obtained is smaller than that which is indicated by the normal characteristic curves, because the alternating plate current generates an alternating plate potential in the load, and the resultant plate potential is no longer a constant voltage, but varies accordingly. A load, in fact, being in series with the plate impedance R_o , has the effect of modifying the characteristics worked on, so that they are the same as the no-load curves, except that R_o is increased. Their slope, in other words, is reduced.

It will be seen that there is no difficulty in actually obtaining load curves (for a given valve working into a

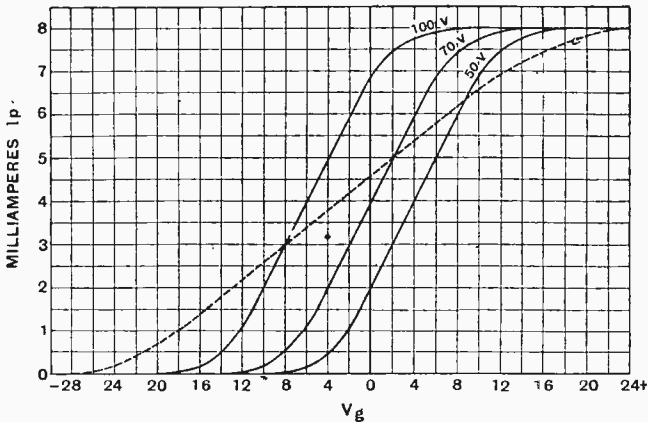

Fig. 6.—Diagram illustrating the effect on the slope of the valve characteristic of a load connected in the anode circuit. The loaded curve is represented by the dotted line.

given load), because we may simply take R_o as becoming R_o plus R_L (where R_L is the load impedance). Let us work out an example. We know that a grid voltage change of 1 volt is equivalent to a plate voltage change of m volts, and that a plate voltage change of 1 volt produces a plate current change of $\frac{m}{R_o}$ ampere. A grid voltage change of 1 volt, therefore, produces a plate current change of $\frac{1}{R_o}$ ampere. This quantity which, when multiplied by 10^6 , is called the "mutual conductivity" of the valve, represents the slope of the ordinary no-load characteristic curves, in terms of the change in plate current, produced by changes in grid voltage. Now, if R_o is changed to $R_o + R_L$, we see at once that the slope of the load curve is $\frac{m}{R_o + R_L}$ ampere per grid volt.

In Fig. 6 the full line curves are the normal no-load curves for a valve in which $m = 5$ and $R_o = 10,000$. The slope is then $\frac{5}{10,000}$ ampere per grid volt, or 0.50 milli-

ampere per grid volt. If the load in the plate circuit of this valve consists of a transformer whose primary impedance is equivalent to a resistance of 15,000 ohms, the slope becomes $\frac{5}{10,000 + 15,000} = 0.20$ milliamperere per grid volt. This load curve is the dotted curve in Fig. 6. A load curve cannot, of course, be determined by a set of D.C. measurements on the valve with the load connected the same as are used in obtaining the no-load curves, because the load generally has a comparatively low D.C. resistance compared with its A.C. resistance. This fact predetermines the value of the steady plate current which will flow (for given plate and grid voltages), and settles for us at which point the load and no-load curves should cross. In Fig. 6 they cross at a plate current of 3 milliamperes, as for this case a plate voltage of 100, and a grid bias of -6 volts, were assumed, and from the no-load curve it was found that these values would result in a plate current of 1.25 milliamperes. The load curve was drawn through this point, with the new slope. It will be seen that it has the same plate circuit range, but that this is spread over a greater grid voltage range, a fact which may somewhat modify the choice of the best grid bias to be used in a given case. In this case the grid bias would be about -3.5 volts.

To plot a load curve, then, one must first choose a suitable plate voltage and grid bias, and from these find the corresponding plate current. The load curve is sketched in the manner described through the same plate current point. By trial it will be possible to find that load curve which will give either (1) the best plate and grid voltages to employ so that the whole straight portion of the curve may be used, or (2) the best grid bias to use so that the maximum grid voltage range may be employed (for a given plate voltage) without grid current flowing, or the straight part of the curve being overlapped.

An exception to this procedure is found when the load consists of an anode resistance. In this case the IR drop in the resistance must be counteracted by an increase of plate voltage. Apart from the extra D.C. plate voltage which is necessary in this case, the calculation is similar to that given above for other types of load.

(To be concluded.)

THE PRINCE OF WALES' TOUR.

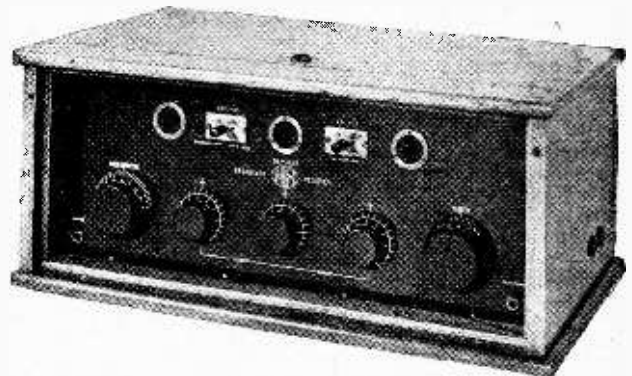

Speech amplifier made by Messrs. L. McMichael, Ltd., and used by the Prince of Wales at Johannesburg to address an assembly of 30,000 natives.

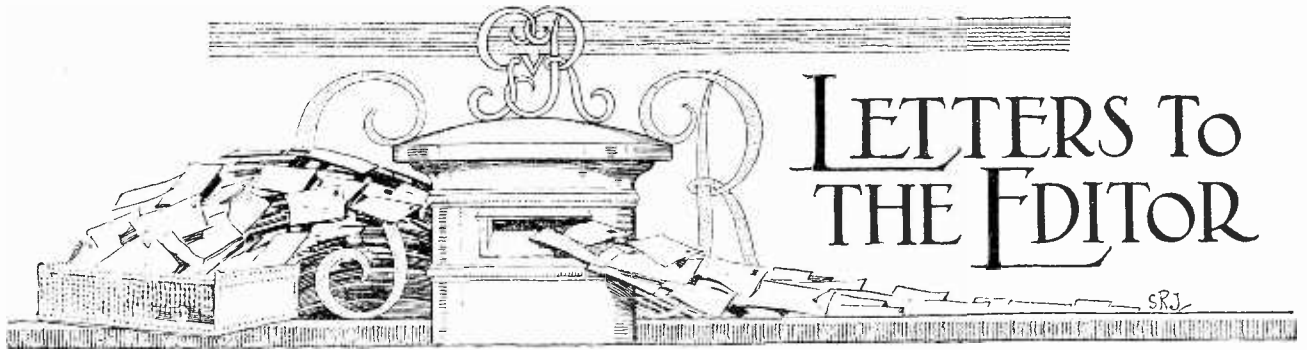

LETTERS TO THE EDITOR

The Editor does not hold himself responsible for the opinions of his correspondents.

Correspondence should be addressed to the Editor, "The Wireless World," 139-140, Fleet Street, E.C.4, and must be accompanied by the writer's name and address.

A DUAL AMPLIFICATION RECEIVER.

Sir,—The accompanying photograph may be of interest to your readers. The circuit embodies the special tuner which Mr. Strachan mentions in *The Wireless World*, No. 221, of November 7th, 1925. For eighteen months experiments have been made with this receiver, and I am pleased to state that the majority of European stations and a few American have been received. Large condenser knobs simplify tuning. The set includes a wave trap and low frequency amplifier. On the left can be seen the trap coil, which becomes tuned anode when the switch is down; of course, the two aerial coils are shorted. Switches on the right control one and two valves. I consider the circuit one of the best, equal, in fact, to 3- or 4-valvers that I have tried. Both the principles of design and the directions given by Mr. Strachan in *The Wireless World*, of which I am a regular reader, are a credit to the *Wireless World*, of which I am a regular reader.

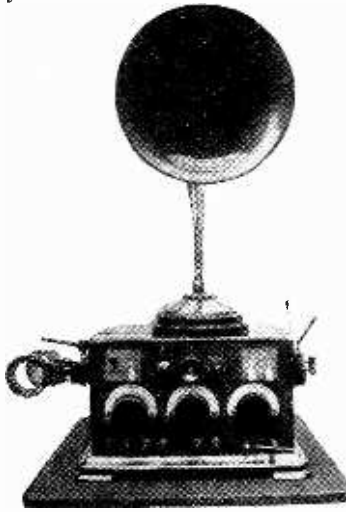

The Dual Receiver referred to by Mr. L. S. Smith.

London, S.E.5

LESLIE S. SMITH.

AMATEUR MORSE.

Sir,—Might I through your excellent medium remind many amateur transmitters, particularly ex-Service operators, that in sending Morse at an excessive speed does not add to the desired DX achievement.

I am one who is always pleased to send full reports on amateur signals received here from 20 metres up, and it is hardly fair when signals come through in one long ripple and I write down NST instead of TEST. Such well-known amateurs as 2NM, 2KF, F8BN, W2BEE (and many others who have sent QSL's to my reports) are quite easy to read because they key and space with feeling for the fellow with good ears and bad 'phones, and I would like to appeal strongly to all transmitters to give us "Slow Ones" kinder Morse or even "QSZ pse O.M." Might I also thank all the transmitters who have sent QSL's to my reports.

Swansea.

J. GEARY (G2BAS).

QSL'S FOR THE LISTENER.

Sir,—The accompanying photograph of my receiving station may interest your readers in view of the recent correspondence

in *Wireless World* on QSL's sent by receiving amateurs. Personally, I have found that amateurs have been very considerate indeed in replying. One aspect, which I think most of your correspondents missed, is that particulars of the transmitting station as to power, etc., may be useful to the receiving amateur who is collecting data.

I might mention that on one valve I have picked up signals from Australia 2CM, NRRL (while at Tahiti), WAP, WNP, and NTT (the U.S.S. "Scorpion" in the Adriatic), Java ANE, and Mosul 1DH.

Sutton, Surrey.

E. J. ERITH

The short wave bands at present adopted by amateur transmitting stations opens up a new field of interest for the listener. Reports of reception are welcomed by transmitting stations, and their cards of acknowledgement indicate the receiving ranges accomplished. The call signs of many well-known transmitters can be recognised in this photograph of Mr. Erith's interception station.



5XX ON A CRYSTAL IN DUBLIN.

Sir,—As many of your readers are impatiently awaiting the opening of the proposed Dublin station, perhaps it might interest those potential crystal set listeners to know that English programmes are available *via* Daventry. On a plain crystal set, moreover, I have logged the following: Liverpool, Nottingham, London, Manchester, Bournemouth, Newcastle, Glasgow, Aberdeen, Hanover, Nuremburg, Hamburg, Münster, Breslau, Oslo, Zurich, Madrid, and Radio-Wien Vienna. My results have been duplicated by a prominent member of the Wireless Society of Ireland, who brought round a commercial set on invitation.

Dublin.

W. F. WARREN.

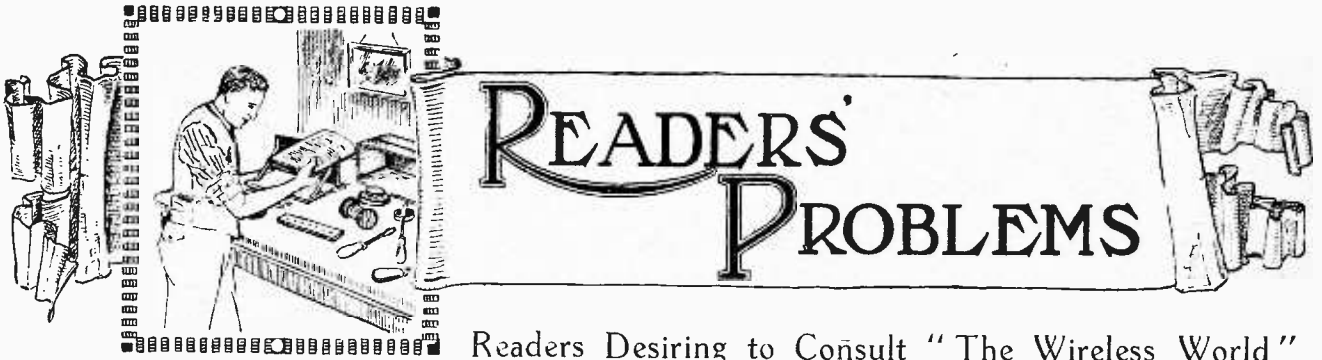

Readers Desiring to Consult "The Wireless World" Information Dept. should make use of the Coupon in the Advertisement Pages.

A Simply Operated High-quality Receiver.

I wish to construct a five-valve receiver to give me ample volume from London and Daventry. My first requirement is quality of reproduction combined with the greatest possible simplicity of operation, as the set will generally be worked by members of my family having no technical knowledge whatever. Please specify types of components where necessary.

A.F.B. (Reading).

A good circuit to meet our correspondent's requirements is given in Fig. 1. D.E.V. and D.E.Q. valves are used respectively as H.F. and anode rectifier, and as they take 3 volts each across the filament, are connected in series across the 6-volt L.T. battery. Grid tuning of the detector valve is adopted, as it makes for increased selectivity without complication. Not more than 36 volts should be applied to the anodes of these valves. The H.F. chokes should have high inductance and low capacity. The type manufactured by the Metropolitan Vickers Co. is suitable.

The resistance in the anode circuits of the third and fourth valves may with advantage be wire wound, such as those made by the Lissen Co. These two valves are of the high magnification type, such as the D.E.5.B., and in the last stage we must use a valve capable of handling a certain amount of power, such as the D.E.5. An on-off switch is fitted in the L.T. positive lead.

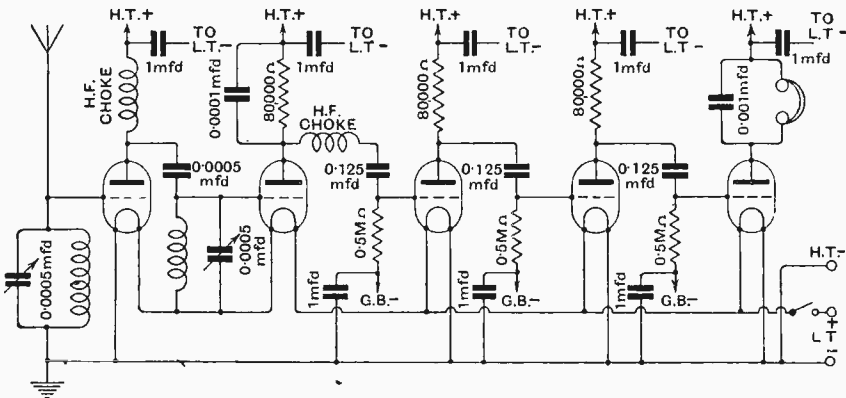

Fig. 1.—Receiver designed to give high-quality loud-speaker reception from Daventry and 2L.O.

The two plug-in coils should be fitted, as far as possible out of inductive relation with each other and with the H.F. chokes.

Our correspondent does not mention his aerial and earth system or local receiving conditions: assuming all these to be good, it is almost certain that the signal intensity would be sufficient to overload the second D.E.5.B. valve. To remedy this, the valve mentioned should be replaced by one of the D.E.5 power class, with a good L.F. choke in its anode circuit in place of the non-inductive resistance shown. The last valve should then be a D.E.5.A., with suitable grid bias and 120 volts on the anode. Given a strong rectified signal, this arrangement would give great volume with the highest practicable degree of purity.

o o o o

Standard Reflex Set.

Please give circuit diagram of a simple single-valve reflex set capable of working a loud-speaker on the local station.

J.C.T. (Birmingham).

Circuit diagram of a standard single-valve reflex is given in Fig. 2. Care must be taken in design, and good components should be used if adequate volume is to be obtained. The L.F. transformer in particular should be of a good make and of high ratio, say 6:1. Quality will be better if a small power valve is used, with ample H.T. voltage.

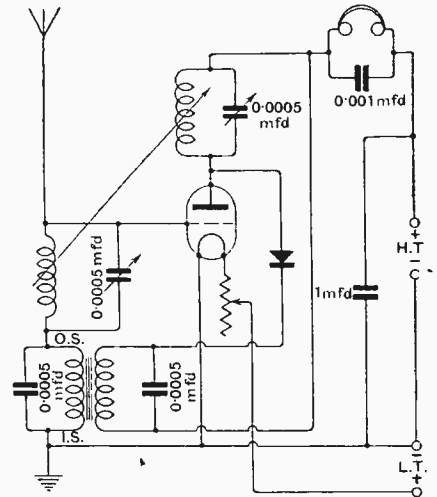

Fig. 2.—Single-valve reflex receiver.

In this case a grid bias battery should certainly be inserted in the lead joining I.S. to negative filament.

o o o o

Calculating Filament Resistance Values.

I have a large collection of valves, and sometimes wish to use types taking widely different filament voltages in the same set from a common L.T. battery. How can the correct value of filament resistance be calculated?

L.T.S. (Edinburgh).

The value of filament resistance can easily be calculated from the simplified formula: "Volts to be dropped in the resistance ÷ current taken by the valve (in amperes)." The rated voltage as given by the maker is taken, and this is subtracted from the voltage of the L.T. battery, the result being divided by the rated consumption of the valve (in amperes).

A couple of examples will be taken to make the matter perfectly clear. Assuming that it is desired to run a valve of the type taking 0.06 ampere at 2.8 volts from a 6-volt battery we get

$$\frac{6 - 2.8}{0.06} = \frac{3.2}{0.06} = 53 \text{ ohms approx.}$$

In the case of a D.E.R. taking 0.55 amp. at 1.8 volts supplied by the same

battery, the figures would be

$$\frac{6-1.8}{0.35} = \frac{4.2}{0.35} = 12 \text{ ohms.}$$

In practice, if a variable resistance is to be used, one of a value slightly in excess of these figures would be selected, in order to allow a margin of safety.

Separate Filament Control.

Is it really necessary to provide a separate filament rheostat for each valve? I notice that this is done in most of your designs.

A.P.D. (Rotherham).

Modern valves are not as a rule particularly sensitive to filament control, and it may be said that a number of valves of the same type, performing the same function, may be controlled by one rheostat. Separate resistances are generally shown, in order to give our readers greater latitude in the choice of valves, and by this method the utmost efficiency may be obtained, if multiplicity of adjustments is not objected to.

The use of individual rheostats will generally be found of real advantage in the case of superionic oscillators and "bottom bend" rectifiers.

resistor may be substituted. The correct value can only be found by experiment; it is quite probable that as much as 50,000 ohms will be necessary.

o o o o

L.F. Amplification after a Crystal Detector.

Having read that a high-ratio transformer should be used after a crystal detector, I recently purchased one of an expensive make having a ratio of 8:1. On substituting this for my previous low ratio and comparatively inexpensive instrument, I was disappointed to find that neither volume nor quality was improved to the slightest degree. Is it probable that the transformer is faulty? My carborundum detector works excellently on a plain crystal set, so the trouble must be elsewhere.

F.A.B. (Brentwood).

Our correspondent's concluding remark reveals the reason for his failure to obtain improved results. A carborundum crystal invariably has too high a resistance to be connected in the primary circuit of an 8:1 transformer, which is, from considerations of winding space available, necessarily of low

Mullard Double Ring DULL FILAMENT Valves

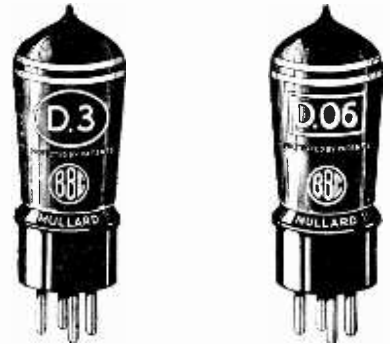

DOUBLE WHITE RING FOR MASTER DETECTION

Mullard Double White Ring Valves have been specially selected for superior detection. They are made in two types:

- Type D '3 for 2-volt accumulators - each 14/-
- Type D '06 for 2 or 3 dry cells or 4-volt accumulators - each 16/6

DOUBLE RED RING FOR H.F. AMPLIFICATION

Mullard Double Red Ring Valves are designed for real long distance reception. They are made in two types:

- Type D '3 for 2-volt accumulators - each 14/-
- Type D '06 for 2 or 3 dry cells or 4-volt accumulators - each 16/6

DOUBLE GREEN RING FOR L.F. AMPLIFICATION

Mullard Double Green Ring Valves are designed for real pure tone reception. They will operate small and medium-sized loudspeakers. Made in two types:

- Type D '3 for 2-volt accumulators - each 14/-
- Type D '06 for 2 or 3 dry cells or 4-volt accumulators - each 16/6

Ask any dealer for leaflet V.R.26.

Mullard
THE MASTER VALVE

Advt.—The Mullard Wireless Service Co., Ltd., Nightingale Lane, Balham, London, S.W.12.

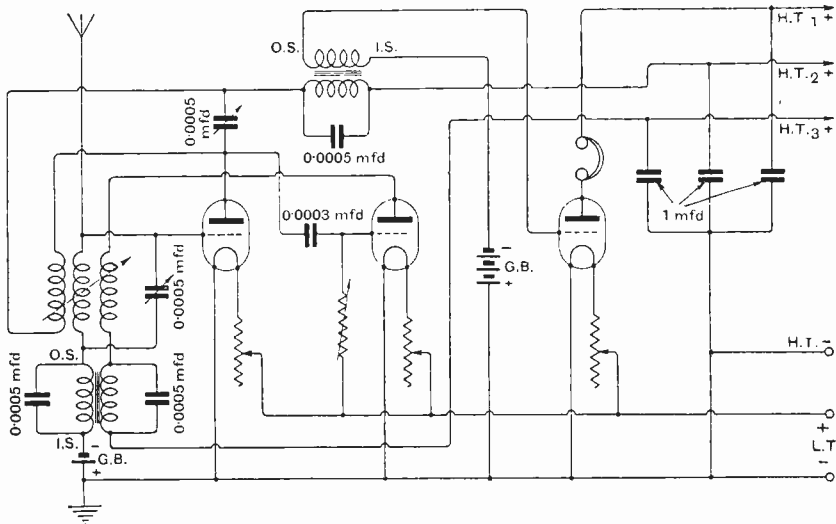

Fig. 3.—Three-valve reflex receiver with valve detector.

'Phones and Loud-speaker.

One of the members of my family is deaf, and usually listens with headphones. When these are connected in parallel with the loud-speaker, however, the volume is excessive. If the output of the receiver is reduced, the volume from the loud-speaker is insufficient. What course would you recommend?

H.O.R. (Sheffield).

We suggest that the loud-speaker is connected to its usual terminals, and the 'phones in series with a variable anode resistance are connected across it. The proportion of current taken by the 'phones is thus under control. If it is found that the variable resistance does not stand up to the work, a fixed

impedance. A lower ratio would be suitable, but if it is not possible to have the transformer changed we would recommend the use of the usual low resistance galena and catwhisker detector in place of carborundum.

o o o o

A Three-valve Reflex without Crystal.

Please publish a circuit diagram of a three-valve set using dual amplification in one stage. If possible, show a valve detector.

W.T.G. (Sutton).

A fairly straightforward circuit of this description is given in Fig. 3. The first valve functions as a combined H.F. and L.F. amplifier, the second as a detector, and the third as an L.F. amplifier.